

Appendices Table of Contents

Appendix A	Submittal Templates	0
A.1	Standard SWQMP	5
A.2	PDP SWQMP.....	25
Appendix B	Storm Water Pollutant Control Hydrologic Calculations and Sizing Methods	
	B-1	
B.1	DCV	B-2
B.1.1	Runoff Factor.....	B-2
B.1.2	Offline BMPs.....	B-3
B.1.3	85th Percentile, 24-Hour Storm Event.....	B-3
B.2	Adjustments to Account for Site Design BMPs.....	B-6
B.2.1	Adjustment to Impervious Runoff Factor.....	B-6
B.2.2	Adjustment to DCV.....	B-8
B.3	Harvest and Use BMPs.....	B-10
B.3.1	Planning Level Harvest and Use Feasibility.....	B-10
B.3.2	Harvested Water Demand Calculation	B-12
B.3.3	Sizing Harvest and Use BMPs.....	B-16
B.4	Infiltration BMPs.....	B-17
B.4.1	Simple Method.....	B-18
B.4.2	Percent Capture Method.....	B-19
B.4.3	Technical Basis for Equivalent Sizing Methods	B-23
B.5	Biofiltration BMPs.....	B-25
B.5.1	Basis for Minimum Sizing Factor for Biofiltration BMPs.....	B-28
B.5.2	Sizing Biofiltration BMPs Downstream of a Storage Unit.....	B-35
B.6	Flow-Through Treatment Control BMPs (for use with Alternative Compliance)	B-38
B.6.1	PDP Most Significant Pollutants of Concern.....	B-38
B.6.2	Selection of Flow-Through Treatment Control BMPs.....	B-41
B.6.3	Sizing Flow-Through Treatment Control BMPs:	B-49
Appendix C	Geotechnical and Groundwater Investigation Requirements	C-1

C.1	Purpose and Phasing	C-1
C.2	Geotechnical Feasibility Criteria.....	C-2
C.2.1	Soil and Geologic Conditions.....	C-2
C.2.2	Settlement and Volume Change.....	C-3
C.2.3	Slope Stability.....	C-3
C.2.4	Utility Considerations	C-3
C.2.5	Groundwater Mounding	C-4
C.2.6	Retaining Walls and Foundations	C-4
C.2.7	Other Factors.....	C-4
C.3	Groundwater Quality and Water Balance Feasibility Criteria.....	C-4
C.3.1	Soil and Groundwater Contamination.....	C-5
C.3.2	Separation to Seasonal High Groundwater.....	C-5
C.3.3	Wellhead Protection.....	C-5
C.3.4	Contamination Risks from Land Use Activities.....	C-5
C.3.5	Consultation with Applicable Groundwater Agencies.....	C-6
C.3.6	Water Balance Impacts on Stream Flow.....	C-6
C.3.7	Downstream Water Rights.....	C-6
C.3.8	Other Factors.....	C-6
C.4	Geotechnical and Groundwater Investigation Report Requirements.....	C-7
C.4.1	Site Evaluation	C-7
C.4.2	Field Investigation.....	C-7
C.4.3	Reporting Requirements by Geotechnical Engineer	C-8
C.4.4	Reporting Requirements by the Project Design Engineer.....	C-9
C.5	Feasibility Screening Exhibits	C-16
Appendix D Approved Infiltration Rate Assessment Methods for Selection and Design of Storm Water BMPs		D-1
D.1	Introduction	D-1
D.2	Role of Infiltration Testing in Different Stages of Project Development.....	D-1
D.3	Guidance for Selecting Infiltration Testing Methods	D-2
D.3.1	Desktop Approaches and Data Correlation Methods.....	D-4
D.3.2	Surface and Shallow Excavation Methods	D-5
D.3.3	Deeper Subsurface Tests.....	D-8
D.4	Specific Considerations for Infiltration Testing.....	D-9

D.4.1 Hydraulic Conductivity versus Infiltration Rate versus Percolation Rate.....	D-10
D.4.2 Cut and Fill Conditions	D-10
D.4.3 Effects of Direct and Incidental Compaction	D-12
D.4.4 Temperature Effects on Infiltration Rate.....	D-12
D.4.5 Number of Infiltration Tests Needed.....	D-13
D.5 Selecting a Safety Factor	D-13
D.5.1 Determining Factor of Safety	D-14
D.5.2 Site Suitability Considerations for Selection of an Infiltration Factor of Safety	D-14
D.5.3 Design Related Considerations for Selection of an Infiltration Factor of Safety	D-16
D.5.4 Implications of a Factor of Safety in BMP Feasibility and Design	D-17
Appendix E BMP Design Fact Sheets.....	E-1
E.1 Source Control BMP Requirements	E-2
E.2 SD-1 Street Trees.....	E-15
E.3 SD-5 Impervious Area Dispersion.....	E-20
E.4 SD-6A: Green Roofs.....	E-24
E.5 SD-6B Permeable Pavement (Site Design BMP).....	E-29
E.6 SD-8 Rain Barrels	E-30
E.7 HU-1 Cistern	E-31
E.8 INF-1 Infiltration Basin.....	E-36
E.9 INF-2 Bioretention.....	E-42
E.10 INF-3 Permeable Pavement (Pollutant Control).....	E-50
E.11 PR-1 Biofiltration with Partial Retention.....	E-58
E.12 BF-1 Biofiltration.....	E-66
E.13 BF-2 Nutrient Sensitive Media Design.....	E-74
E.14 BF-3 Proprietary Biofiltration Systems	E-77
E.15 FT-1 Vegetated Swales.....	E-78
E.16 FT-2 Media Filters	E-84
E.17 FT-3 Sand Filters	E-88
E.18 FT-4 Dry Extended Detention Basin.....	E-94
E.19 FT-5 Proprietary Flow-Through Treatment Control BMPs	E-99
E.20 PL Plant List	E-100
Appendix F Biofiltration Standard and Checklist.....	F-1
F.1 Pollutant Treatment Performance Standard.....	F-8

F.2	Guidance on Sizing and Design of Non-Standard Biofiltration BMPs	F-12
F.2.1	Guidance on Design per Conditions of Certification/Verification	F-12
F.2.2	Sizing of Flow-Based Biofiltration BMP	F-12
Appendix G Guidance for Continuous Simulation and Hydromodification Management Sizing Factors		G-1
G.1	Guidance for Continuous Simulation Hydrologic Modeling for Hydromodification Management Studies in San Diego County Region 9	G-1
G.1.1	Introduction	G-1
G.1.2	Software for Continuous Simulation Hydrologic Modeling.....	G-2
G.1.3	Climatology Parameters.....	G-2
G.1.4	LAND CHARACTERISTICS AND LOSS PARAMETERS	G-7
G.1.5	MODELING STRUCTURAL BMPS (PONDS AND LID FEATURES).....	G-13
G.1.6	FLOW FREQUENCY AND DURATION.....	G-18
G.2	Sizing Factors for Hydromodification Management BMPs.....	G-21
G.2.1	Unit Runoff Ratios.....	G-25
G.2.2	Sizing Factors for "Infiltration" BMP	G-27
G.2.3	Sizing Factors for Bioretention	G-32
G.2.4	Sizing Factors for Biofiltration with Partial Retention and Biofiltration.....	G-37
G.2.5	Sizing Factors for Biofiltration with Impermeable Liner.....	G-43
G.2.6	Sizing Factors for "Cistern" BMP.....	G-49
Appendix H Guidance for Investigating Potential Critical Coarse Sediment Yield Areas		H-1
H.1	Criteria for GLU Analysis.....	H-3
H.2	Optional Additional Analysis When Potential Critical Coarse Sediment Yield Areas are Present Onsite	H-18
Appendix I Glossary of Key Terms		i

A.1 Standard SWQMP

The standard SWQMP Template and Instructions are offered as a tool to assist users in complying with RWQCB Order NO. R9-2015-0001 (Permit), and is not intended to warrant or guarantee Permit compliance, which is the independent and sole responsibility of the user. The Template is subject to revision without notice, at any time.

Plan Number(s): LD _____ PC _____ GP _____

City of Vista  CITY OF VISTA CALIFORNIA
STANDARD DEVELOPMENT PROJECT STORM WATER QUALITY MANAGEMENT PLAN FOR [PROJECT NAME]
ENGINEER OF WORK
INSERT NAME OF EOW- PE NUMBER –EXPIRATION – WET SIGNATURE & STAMP

PREPARED FOR:

[INSERT APPLICANT NAME]
[INSERT ADDRESS]
[INSERT CITY, STATE ZIP CODE]
[INSERT TELEPHONE NUMBER]
[INSERT EMAIL]

STANDARD PROJECT SWQMP PREPARED BY:

[INSERT ENGINEER-OF-WORK]
[INSERT ADDRESS]
[INSERT CITY, STATE, ZIP CODE]
[INSERT TELEPHONE NUMBER]
[INSERT EMAIL]

PREPARED: MONTH, YEAR

STORM WATER QUALITY MANAGEMENT PLAN

Reviewed and Approved:

City Engineer

Date

TABLE OF CONTENTS

1. Acronym Sheet
2. Standard Project SWQMP Project Owner's Certification Page
3. Project Vicinity Map
4. Form 1 - Checklist for New and Redevelopment: Applicability of Permanent, Post-Construction Storm Water BMP Requirements and Project Type Determination
5. FORM 2 - Site Information Checklist for Standard Projects
6. FORM 3 - Source Control BMP Checklist for All Development Projects
7. FORM 4 - Site Design BMP Checklist for All Development Projects
8. Attachment 1: Copy of Plan Sheets Showing Permanent Storm Water BMPs

Project Name

(Permit Application Number, e.g. LD13-XXX)

Standard Development Storm Water Quality Management Plan

Page XX

Company Name

ACRONYMS

APN	Assessor's Parcel Number
BMP	Best Management Practice
HMP	Hydromodification Management Plan
HSG	Hydrologic Soil Group
MS4	Municipal Separate Storm Sewer System
N/A	Not Applicable
NRCS	Natural Resources Conservation Service
PDP	Priority Development Project
PE	Professional Engineer
SC	Source Control
SD	Site Design
SDRWQCB	San Diego Regional Water Quality Control Board
SIC	Standard Industrial Classification
SWQMP	Storm Water Quality Management Plan

Project Name

(Permit Application Number, e.g. LD13-XXX)

Standard Development Storm Water Quality Management Plan

Page XX

Company Name

STANDARD PROJECT SWQMP PROJECT OWNER'S CERTIFICATION PAGE

Project Name: [Insert Project Name]
Permit Application Number: [Insert Permit Application Number]

PROJECT OWNER'S CERTIFICATION

This Standard Project SWQMP has been prepared for [INSERT PROJECT OWNER'S COMPANY NAME] by [INSERT SWQMP PREPARER'S COMPANY NAME]. The Standard Project SWQMP is intended to comply with the Standard Project requirements of the City of Vista (City) BMP Design Manual, which is a design manual for compliance with local City and regional MS4 Permit (California Regional Water Quality Control Board San Diego Region Order No. 2013-0001, as amended by Order No. R9-2015-0001) requirements for storm water management.

The undersigned, while it owns the subject property, is responsible for the implementation of the provisions of this plan. Once the undersigned transfers its interests in the property, its successor-in-interest shall bear the aforementioned responsibility to implement the best management practices (BMPs) described within this plan. A signed copy of this document shall be available on the subject property into perpetuity.

Project Owner's Signature

Print Name

Company

Date

E-mail

Page intentionally blank

SUBMITTAL RECORD

Use this Table to keep a record of submittals of this Standard Project SWQMP. Each time the Standard Project SWQMP is re-submitted, provide the date and status of the project. In column 4 summarize the changes that have been made or indicate if response to plancheck comments is included. When applicable, insert response to plancheck comments behind this page.

Submittal Number	Date	Project Status	Summary of Changes
1		<input type="checkbox"/> Preliminary Design / Planning/ CEQA <input type="checkbox"/> Final Design	Initial Submittal
2		<input type="checkbox"/> Preliminary Design / Planning/ CEQA <input type="checkbox"/> Final Design	
3		<input type="checkbox"/> Preliminary Design / Planning/ CEQA <input type="checkbox"/> Final Design	
4		<input type="checkbox"/> Preliminary Design / Planning/ CEQA <input type="checkbox"/> Final Design	

Project Name

(Permit Application Number, e.g. LD13-XXX)

Standard Development Storm Water Quality Management Plan

Page XX

Company Name

PROJECT VICINITY MAP

Project Name: [Insert Project Name]

Permit Application Number: [Insert Permit Application Number]

[Insert Project Vicinity Map here]

Form 1: Insert completed Checklist *for New and Redevelopment: Applicability of Permanent, Post-Construction Storm Water BMP Requirements and Project Type Determination*

Form 2 - Site Information Checklist For Standard Projects

City of Vista BMP Design Manual

Project Summary Information

Project Name	
Project Address	
Assessor's Parcel Number(s) (APN(s))	
Permit Application Number	
Watershed	Hydrologic Area and Sub-Area (select appropriate checkbox)
San Luis Rey	<input type="checkbox"/> Lower San Luis Rey – Mission, 903.11
Carlsbad	<input type="checkbox"/> Loma Alta – Loma Alta, 904.10
	<input type="checkbox"/> Buena Vista – El Salto, 904.21
	<input type="checkbox"/> Buena Vista – Vista, 904.22
	<input type="checkbox"/> Agua Hedionda – Los Monos, 904.31
	<input type="checkbox"/> Agua Hedionda – Buena, 904.32
	<input type="checkbox"/> San Marcos – Batiquitos, 904.51
Project Watershed (Complete Hydrologic Unit, Area, and Subarea Name with Numeric Identifier)	_____ Acres (_____ Square Feet)
Parcel Area (total area of Assessor's Parcel(s) associated with the project)	_____ Acres (_____ Square Feet)
Area to be Disturbed by the Project (Project Area)	_____ Acres (_____ Square Feet)
Project Proposed Impervious Area (subset of Project Area)	_____ Acres (_____ Square Feet)
Project Proposed Pervious Area (subset of Project Area)	_____ Acres (_____ Square Feet)

Project Name

(Permit Application Number, e.g. LD13-XXX)

Standard Development Storm Water Quality Management Plan

Company Name

Page XX

Description of Existing Site Condition and Drainage Patterns

Current Status of the Site (select all that apply):

- Existing development
- Previously graded but not built out
- Demolition completed without new construction
- Agricultural or other non-impervious use
- Vacant, undeveloped/natural

Description / Additional Information:

Existing Land Cover Includes (select all that apply):

- Vegetative Cover
- Non-Vegetated Pervious Areas
- Impervious Areas

Description / Additional Information:

Underlying Soil belongs to Hydrologic Soil Group (select all that apply):

- NRCS Type A
- NRCS Type B
- NRCS Type C
- NRCS Type D

Existing Natural Hydrologic Features (select all that apply):

- Drainage Ditch/Swale
- Seeps
- Springs
- Wetlands
- None

Description / Additional Information:

Description of Existing Site Drainage [How is storm water runoff conveyed from the site? At a minimum, this description should answer (1) whether existing drainage conveyance is natural or urban; (2) describe existing constructed storm water conveyance systems, if applicable; and (3) is runoff from offsite conveyed through the site? if so, describe.]:

Project Name

(Permit Application Number, e.g. LD13-XXX)

Standard Development Storm Water Quality Management Plan

Page XX

Company Name

Description of Proposed Site Development and Drainage Patterns

Project Description / Proposed Land Use and/or Activities:

List proposed impervious features of the project (e.g., buildings, roadways, parking lots, courtyards, athletic courts, other impervious features):

List proposed pervious features of the project (e.g., landscape areas):

Does the project include grading and changes to site topography?

- Yes
- No

Description / Additional Information:

Does the project include changes to site drainage (e.g., installation of new storm water conveyance systems)?

- Yes
- No

Description / Additional Information:

Project Name

(Permit Application Number, e.g. LD13-XXX)

Standard Development Storm Water Quality Management Plan

Page XX

Company Name

Identify whether any of the following features, activities, and/or pollutant source areas will be present (select all that apply):

- On-site storm drain inlets
- Interior floor drains and elevator shaft sump pumps
- Interior parking garages
- Need for future indoor & structural pest control
- Landscape/Outdoor Pesticide Use
- Pools, spas, ponds, decorative fountains, and other water features
- Food service
- Refuse areas
- Industrial processes
- Outdoor storage of equipment or materials
- Vehicle and Equipment Cleaning
- Vehicle/Equipment Repair and Maintenance
- Fuel Dispensing Areas
- Loading Docks
- Fire Sprinkler Test Water
- Miscellaneous Drain or Wash Water
- Plazas, sidewalks, and parking lots

Description / Additional Information:

Project Name

(Permit Application Number, e.g. LD13-XXX)

Standard Development Storm Water Quality Management Plan

Page XX

Company Name

**Form 3 - Source Control BMP Checklist
for All Development Projects
(Standard Projects and Priority Development Projects)**

City of Vista BMP Design
Manual

Project Identification

Project Name

Permit Application Number

Source Control BMPs

All development projects must implement source control BMPs SC-1 through SC-6 where applicable and feasible. See Chapter 4 and Appendix E of the Model BMP Design Manual for information to implement source control BMPs shown in this checklist.

Answer each category below pursuant to the following.

- "Yes" means the project will implement the source control BMP as described in Chapter 4 and/or Appendix E of the Model BMP Design Manual. Discussion / justification is not required.
- "No" means the BMP is applicable to the project but it is not feasible to implement. Discussion / justification must be provided.
- "N/A" means the BMP is not applicable at the project site because the project does not include the feature that is addressed by the BMP (e.g., the project has no outdoor materials storage areas). Discussion / justification may be provided.

Source Control Requirement

Applied?

SC-1 Prevention of Illicit Discharges into the MS4

Yes

No

N/A

Discussion / justification if SC-1 not implemented:

SC-2 Storm Drain Stenciling or Signage

Yes

No

N/A

Discussion / justification if SC-2 not implemented:

SC-3 Protect Outdoor Materials Storage Areas from Rainfall, Run-On, Runoff, and Wind Dispersal

Yes

No

N/A

Discussion / justification if SC-3 not implemented:

SC-4 Protect Materials Stored in Outdoor Work Areas from Rainfall, Run-On, Runoff, and Wind Dispersal

Yes

No

N/A

Discussion / justification if SC-4 not implemented:

Project Name

(Permit Application Number, e.g. LD13-XXX)

Standard Development Storm Water Quality Management Plan

Page XX

Company Name

Project Identification

Project Name

Permit Application Number

Site Design BMPs

All development projects must implement site design BMPs SD-1 through SD-8 where applicable and feasible. See Chapter 4 and Appendix E of the Model BMP Design Manual for information to implement site design BMPs shown in this checklist.

Answer each category below pursuant to the following.

- "Yes" means the project will implement the site design BMP as described in Chapter 4 and/or Appendix E of the Model BMP Design Manual. Discussion / justification is not required.
- "No" means the BMP is applicable to the project but it is not feasible to implement. Discussion / justification must be provided.
- "N/A" means the BMP is not applicable at the project site because the project does not include the feature that is addressed by the BMP (e.g., the project site has no existing natural areas to conserve). Discussion / justification may be provided.

Site Design Requirement	Applied?		
-------------------------	----------	--	--

SD-1 Maintain Natural Drainage Pathways and Hydrologic Features	<input type="checkbox"/> Yes	<input type="checkbox"/> No	<input type="checkbox"/> N/A
------------------------------------------------------------------------	------------------------------	-----------------------------	------------------------------

Discussion / justification if SD-1 not implemented:

SD-2 Conserve Natural Areas, Soils, and Vegetation	<input type="checkbox"/> Yes	<input type="checkbox"/> No	<input type="checkbox"/> N/A
-----------------------------------------------------------	------------------------------	-----------------------------	------------------------------

Discussion / justification if SD-2 not implemented:

SD-3 Minimize Impervious Area	<input type="checkbox"/> Yes	<input type="checkbox"/> No	<input type="checkbox"/> N/A
--------------------------------------	------------------------------	-----------------------------	------------------------------

Discussion / justification if SD-3 not implemented:

SD-4 Minimize Soil Compaction	<input type="checkbox"/> Yes	<input type="checkbox"/> No	<input type="checkbox"/> N/A
--------------------------------------	------------------------------	-----------------------------	------------------------------

Discussion / justification if SD-4 not implemented:

Site Design Requirement	Applied?		
SD-5 Impervious Area Dispersion	<input type="checkbox"/> Yes	<input type="checkbox"/> No	<input type="checkbox"/> N/A
Discussion / justification if SD-5 not implemented:			
SD-6 Runoff Collection	<input type="checkbox"/> Yes	<input type="checkbox"/> No	<input type="checkbox"/> N/A
Discussion / justification if SD-6 not implemented:			
SD-7 Landscaping with Native or Drought Tolerant Species	<input type="checkbox"/> Yes	<input type="checkbox"/> No	<input type="checkbox"/> N/A
Discussion / justification if SD-7 not implemented:			
SD-8 Harvesting and Using Precipitation	<input type="checkbox"/> Yes	<input type="checkbox"/> No	<input type="checkbox"/> N/A
Discussion / justification if SD-8 not implemented:			

ATTACHMENT 1
Copy of Plan Sheets Showing Permanent Storm Water BMPs

This is the cover sheet for Attachment 1.

Use this checklist to ensure the required information has been included on the plans:

The plans must identify:

- Show all applicable permanent site design and source control BMPs as noted in Forms 3 and 4

A.2 PDP SWQMP

The Priority SWQMP Template and Instructions are offered as a tool to assist users in complying with RWQCB Order No. R9-2015-0001 (Permit), and is not intended to warrant or guarantee Permit compliance, which is the independent and sole responsibility of the user. The Template is subject to revision without notice, at any time.

Plan Number(s): LD _____ PC _____ GP _____

 CITY OF VISTA CALIFORNIA
PRIORITY DEVELOPMENT PROJECT STORM WATER QUALITY MANAGEMENT PLAN FOR [PROJECT NAME]
ENGINEER OF WORK:
INSERT NAME OF EOW- PE NUMBER-EXPIRATION-WET SIGNATURE & STAMP

PREPARED FOR:
[INSERT APPLICANT NAME]
[INSERT ADDRESS]
[INSERT CITY, STATE ZIP CODE]
[INSERT TELEPHONE NUMBER]
[INSERT EMAIL]

Priority PROJECT SWQMP PREPARED BY:
[INSERT ENGINEER-OF-WORK]
[INSERT ADDRESS]
[INSERT CITY, STATE, ZIP CODE]
[INSERT TELEPHONE NUMBER]
[INSERT EMAIL]

PREPARED: MONTH, YEAR

STORM WATER QUALITY MANAGEMENT PLAN

Reviewed and Approved:

City Engineer

Date

PDP SWQMP PREPARER'S CERTIFICATION PAGE

Project Name: [Insert Project Name]

Permit Application Number: [Insert Permit Application Number]

PREPARER'S CERTIFICATION

I hereby declare that I am the Engineer in Responsible Charge of design of storm water best management practices (BMPs) for this project, and that I have exercised responsible charge over the design of the BMPs as defined in Section 6703 of the Business and Professions Code, and that the design is consistent with the PDP requirements of the City of Vista BMP Design Manual, which is a design manual for compliance with local City and regional MS4 Permit (California Regional Water Quality Control Board San Diego Region Order No. R9-2015-0100) requirements for storm water management.

I have read and understand that the City Engineer has adopted minimum requirements for managing urban runoff, including storm water, from land development activities, as described in the BMP Design Manual. I certify that this PDP SWQMP has been completed to the best of my ability and accurately reflects the project being proposed and the applicable BMPs proposed to minimize the potentially negative impacts of this project's land development activities on water quality. I understand and acknowledge that the plan check review of this PDP SWQMP by the City Engineer is confined to a review and does not relieve me, as the Engineer in Responsible Charge of design of storm water BMPs for this project, of my responsibilities for project design.

Engineer of Work's Signature, PE Number & Expiration Date

Print Name

Company

Date

E-mail

TABLE OF CONTENTS

1. Title Sheet
2. PDP SWQMP Preparer's Certification Page
3. Acronym Sheet
4. PDP SWQMP Project Owner's Certification Page
5. Submittal Record
6. Project Vicinity Map
7. FORM 1 - Checklist for New and Redevelopment: Applicability of Permanent, Post-Construction Storm Water BMP Requirements and Project Type Determination
8. FORM 2 - Site Information Checklist for PDPs
9. FORM 3 - Source Control BMP Checklist for All Development Projects
10. FORM 4 - Site Design BMP Checklist for All Development Projects
11. FORM 5 - Summary of PDP Structural BMPs
12. FORM 6 - Projected Storm Water BMP Maintenance Mechanism
13. Attachment 1: Backup for PDP Pollutant Control BMPs
 - a. Attachment 1a: DMA Exhibit
 - b. Attachment 1b: Tabular Summary of DMAs and Design Capture Volume Calculations
 - c. Attachment 1c: Harvest and Use Feasibility Screening (when applicable)
 - d. Attachment 1d: Categorization of Infiltration Feasibility Condition (when applicable)
 - e. Attachment 1e: Pollutant Control BMP Design Worksheets / Calculations
14. Attachment 2: Backup for PDP Hydromodification Control Measures
 - a. Attachment 2a: Hydromodification Management Exhibit
 - b. Attachment 2b: Management of Critical Coarse Sediment Yield Areas
 - c. Attachment 2c: Geomorphic Assessment of Receiving Channels
 - d. Attachment 2d: Flow Control Facility Design
15. Attachment 3: Structural BMP Maintenance Plan
 - a. Attachment 3a: B Structural BMP Maintenance Thresholds and Actions
 - b. Attachment 3b: Draft Maintenance Agreement (when applicable)
16. Attachment 4: Copy of Plan Sheets Showing Permanent Storm Water BMPs

Project Name

(Permit Application Number, e.g. LD13-XXX)

Standard Development Storm Water Quality Management Plan

Page XX

Company Name

ACRONYMS

APN	Assessor's Parcel Number
BMP	Best Management Practice
HMP	Hydromodification Management Plan
HSG	Hydrologic Soil Group
MS4	Municipal Separate Storm Sewer System
N/A	Not Applicable
NRCS	Natural Resources Conservation Service
PDP	Priority Development Project
PE	Professional Engineer
SC	Source Control
SD	Site Design
SDRWQCB	San Diego Regional Water Quality Control Board
SIC	Standard Industrial Classification
SWQMP	Storm Water Quality Management Plan

Project Name

(Permit Application Number, e.g. LD13-XXX)

Standard Development Storm Water Quality Management Plan

Page XX

Company Name

Page intentionally blank

PDP SWQMP PROJECT OWNER'S CERTIFICATION PAGE

Project Name: [Insert Project Name]

Permit Application Number: [Insert Permit Application Number]

PROJECT OWNER'S CERTIFICATION

This PDP SWQMP has been prepared for [INSERT PROJECT OWNER'S COMPANY NAME] by [INSERT SWQMP PREPARER'S COMPANY NAME]. The PDP SWQMP is intended to comply with the PDP requirements of the City of Vista BMP Design Manual, which is a design manual for compliance with local City and regional MS4 Permit (California Regional Water Quality Control Board San Diego Region Order No. R9-2015-0100) requirements for storm water management.

The undersigned, while it owns the subject property, is responsible for the implementation of the provisions of this plan. Once the undersigned transfers its interests in the property, its successor-in-interest shall bear the aforementioned responsibility to implement the best management practices (BMPs) described within this plan, including ensuring on-going operation and maintenance of structural BMPs. A signed copy of this document shall be available on the subject property into perpetuity.

Project Owner's Signature

Print Name

Company

Company Address and Phone Number

Date

E-mail

Project Name

(Permit Application Number, e.g. LD13-XXX)

Standard Development Storm Water Quality Management Plan

Page XX

Company Name

Page intentionally blank

PROJECT VICINITY MAP

Project Name: [Insert Project Name]

Permit Application Number: [Insert Permit Application Number]

[Insert Project Vicinity Map here]

Form 1: Insert completed *Checklist for New and Redevelopment: Applicability of Permanent, Post-Construction Storm Water BMP Requirements and Project Type Determination*

**Form 2 - Site Information Checklist
For PDPs**

City of Vista BMP Design
Manual

Project Summary Information

Project Name			
Project Address			
Assessor's Parcel Number(s) (APN(s))			
Permit Application Number			
Project Hydrologic Unit, Select One:	Hydrologic Area	Hydrologic Sub-Area	
<input type="checkbox"/> San Luis Rey - 903.00	<input type="checkbox"/> Lower San Luis 903.10	<input type="checkbox"/> Mission 903.11	
	<input type="checkbox"/> Carlsbad - 904.00	<input type="checkbox"/> Buena Vista Creek 904.20	<input type="checkbox"/> El Salto 904.21 <input type="checkbox"/> Vista 904.22
<input type="checkbox"/> Agua Hedionda 904.30		<input type="checkbox"/> Los Monos 904.31 <input type="checkbox"/> Buena 904.32	
<input type="checkbox"/> San Marcos 904.50		<input type="checkbox"/> Batiquitos 904.51	
Parcel Area (total area of Assessor's Parcel(s) associated with the project)	_____ Acres (_____ Square Feet)		
Area to be Disturbed by the Project (Project Area)	_____ Acres (_____ Square Feet)		
Project Proposed Impervious Area (subset of Project Area)	_____ Acres (_____ Square Feet)		
Project Proposed Pervious Area (subset of Project Area)	_____ Acres (_____ Square Feet)		
Note: Proposed Impervious Area + Proposed Pervious Area = Area to be Disturbed by the Project. This may be less than the Parcel Area.			

Description of Existing Site Condition

Current Status of the Site (select all that apply and describe below):

- Existing development
- Previously graded but not built out
- Demolition completed without new construction
- Agricultural or other non-impervious use
- Vacant, undeveloped/natural

Describe:

Existing Land Cover Includes (select all that apply and describe below):

- Vegetative Cover
- Non-Vegetated Pervious Areas
- Impervious Areas

Describe:

Underlying Soil belongs to Hydrologic Soil Group (select all that apply):

- NRCS Type A
- NRCS Type B
- NRCS Type C
- NRCS Type D

Approximate Depth to Groundwater (GW):

- GW Depth < 5 feet
- 5 feet < GW Depth < 10 feet
- 10 feet < GW Depth < 20 feet
- GW Depth > 20 feet

Existing Natural Hydrologic Features (select all that apply and describe in next section):

- Drainage ditch/Swale/Waterways
- Seeps
- Springs
- Wetlands
- None

Project Name

(Permit Application Number, e.g. LD13-XXX)

Standard Development Storm Water Quality Management Plan

Page XX

Company Name

Description of Existing Site Drainage Patterns

How is storm water runoff conveyed from the site? At a minimum, this description should answer:

- (1) Is existing site drainage conveyance natural or improved storm drain (urbanized);
- (2) Is runoff from offsite conveyed through the site? If yes, quantify all offsite drainage areas, design flows, and locations where offsite flows enter the project site, and summarize how such flows are conveyed through the site;
- (3) Provide details regarding existing project site drainage conveyance network, including any existing storm drains, concrete channels, swales, detention facilities, storm water treatment facilities, natural or constructed channels; and
- (4) Identify all discharge locations from the existing project site along with a summary of conveyance system size and capacity for each of the discharge locations. Provide summary of the pre-project drainage areas and design flows to each of the existing runoff discharge locations.

Describe existing site drainage patterns:

Project Name

(Permit Application Number, e.g. LD13-XXX)

Standard Development Storm Water Quality Management Plan

Page XX

Company Name

Description of Proposed Site Development

Project Description / Proposed Land Use and/or Activities:

List/describe proposed impervious features of the project (e.g., buildings, roadways, parking lots, courtyards, athletic courts, other impervious features):

List/describe proposed pervious features of the project (e.g., landscape areas):

Does the project include grading and changes to site topography?

Yes

No

Describe:

Project Name

(Permit Application Number, e.g. LD13-XXX)

Standard Development Storm Water Quality Management Plan

Page XX

Company Name

Description of Proposed Site Drainage Patterns

Does the project include changes to site drainage (e.g., installation of new storm water conveyance systems)?

- Yes
- No

If yes, provide details regarding the proposed project site drainage conveyance network, including storm drains, concrete channels, swales, detention facilities, storm water treatment facilities, natural or constructed channels, and the method for conveying offsite flows through or around the proposed project site. Identify all discharge locations from the proposed project site along with a summary of the conveyance system size and capacity for each of the discharge locations. Provide a summary of pre- and post-project drainage areas and design flows to each of the runoff discharge locations. Reference the drainage study for detailed calculations.

Describe proposed site drainage patterns:

Project Name

(Permit Application Number, e.g. LD13-XXX)

Standard Development Storm Water Quality Management Plan

Page XX

Company Name

Identification and Narrative of Receiving Water and Pollutants of Concern

Describe flow path of storm water from the project site discharge location(s), through urban storm conveyance systems as applicable, to receiving creeks, rivers, and lagoons as applicable, and ultimate discharge to the Pacific Ocean (or bay, lagoon, lake or reservoir, as applicable):

List any 303(d) impaired water bodies within the path of storm water from the project site to the Pacific Ocean (or bay, lagoon, lake or reservoir, as applicable), identify the pollutant(s)/stressor(s) causing impairment, and identify any TMDLs and/or Highest Priority Pollutants from the WQIP for the impaired water bodies:

303(d) Impaired Water Body	Pollutant(s)/Stressor(s)	TMDLs / WQIP Highest Priority Pollutant

Identification of Project Site Pollutants*

***Identification of project site pollutants is only required if flow-thru treatment BMPs are implemented onsite in lieu of retention or biofiltration BMPs (note the project must also participate in an alternative compliance program unless prior lawful approval to meet earlier PDP requirements is demonstrated)**

Identify pollutants expected from the project site based on all proposed use(s) of the site (see BMP Design Manual Appendix B.6):

Pollutant	Not Applicable to the Project Site	Expected from the Project Site	Also a Receiving Water Pollutant of Concern
Sediment			
Nutrients			
Heavy Metals			
Organic Compounds			
Trash & Debris			
Oxygen Demanding Substances			
Oil & Grease			
Bacteria & Viruses			
Pesticides			

Project Name

(Permit Application Number, e.g. LD13-XXX)

Standard Development Storm Water Quality Management Plan

Page XX

Company Name

Hydromodification Management Requirements

Do hydromodification management requirements apply (see Section 1.6 of the BMP Design Manual; select one box and describe below)?

- Yes, hydromodification management flow control structural BMPs required.
- No, the project will discharge runoff directly to existing underground storm drains discharging directly to water storage reservoirs, lakes, enclosed embayments, or the Pacific Ocean.
- No, the project will discharge runoff directly to conveyance channels whose bed and bank are concrete-lined all the way from the point of discharge to water storage reservoirs, lakes, enclosed embayments, or the Pacific Ocean.
- No, the project will discharge runoff directly to an area identified as appropriate for an exemption by the WMAA for the watershed in which the project resides.

Describe:

Critical Coarse Sediment Yield Areas*

***This Section only required if hydromodification management requirements apply**

Based on the maps provided within the WMAA, do potential critical coarse sediment yield areas exist within the project drainage boundaries (select all that apply and describe below)? Additional signed and stamped reports must be provided to document any exemption from coarse sediment yield requirements.

- Yes
- No, No critical coarse sediment yield areas to be protected based on WMAA maps

If yes, have any of the optional analyses presented in Section 6.2 of the BMP Design Manual been performed?

- 6.2.1 Verification of Geomorphic Landscape Units (GLUs) Onsite
- 6.2.2 Downstream Systems Sensitivity to Coarse Sediment
- 6.2.3 Optional Additional Analysis of Potential Critical Coarse Sediment Yield Areas Onsite
- No optional analyses performed, the project will avoid critical coarse sediment yield areas identified based on WMAA maps

If optional analyses were performed, what is the final result?

- No critical coarse sediment yield areas to be protected based on verification of GLUs onsite
- Critical coarse sediment yield areas exist but additional analysis has determined that protection is not required. Documentation attached in Attachment 2.b of the SWQMP.
- Critical coarse sediment yield areas exist and require protection. The project will implement management measures described in Sections 6.2.4 and 6.2.5 as applicable, and the areas are identified on the SWQMP Exhibit.

Describe:

Project Name

(Permit Application Number, e.g. LD13-XXX)

Standard Development Storm Water Quality Management Plan

Page XX

Company Name

Flow Control for Post-Project Runoff*

***This Section only required if hydromodification management requirements apply**

List and describe point(s) of compliance for hydromodification management flow control (see Section 6.3.1). Identify each point of compliance for flow control on the Hydromodification Management Exhibit in Attachment 2a.

Has a geomorphic assessment been performed for the receiving channel(s)?

- No, the low flow threshold is 0.1Q2 (default low flow threshold)
- Yes, the result is the low flow threshold is 0.1Q2
- Yes, the result is the low flow threshold is 0.3Q2
- Yes, the result is the low flow threshold is 0.5Q2

If a geomorphic assessment has been performed, provide the report.

Discussion / Additional Information: (optional)

Project Name

(Permit Application Number, e.g. LD13-XXX)

Standard Development Storm Water Quality Management Plan

Page XX

Company Name

Other Site Requirements and Constraints

When applicable, list other site requirements or constraints that will influence storm water management design, such as zoning requirements including setbacks and open space, or local codes governing minimum street width, sidewalk construction, allowable pavement types, and drainage requirements.

Optional Additional Information or Continuation of Previous Sections As Needed

This space provided for additional information or continuation of information from previous sections as needed.

Project Name

(Permit Application Number, e.g. LD13-XXX)

Standard Development Storm Water Quality Management Plan

Page XX

Company Name

Project Identification

Project Name

Permit Application Number

Source Control BMPs

All development projects must implement source control BMPs SC-1 through SC-6, unless justification is provided by qualified design professional See Chapter 4 and Appendix E of the Model BMP Design Manual for information to implement source control BMPs shown in this checklist.

Answer each category below pursuant to the following, and provide description.

- "Yes" means the project will implement the source control BMP as described in Chapter 4 and/or Appendix E of the Model BMP Design Manual.
- "No" means the BMP is applicable to the project but it is not feasible to implement.
- "N/A" means the BMP is not applicable at the project site because the project does not include the feature that is addressed by the BMP (e.g., the project has no outdoor materials storage areas).

Source Control Requirement	Applied?		
----------------------------	----------	--	--

SC-1 Prevention of Illicit Discharges into the MS4	<input type="checkbox"/> Yes	<input type="checkbox"/> No	<input type="checkbox"/> N/A
-----------------------------------------------------------	------------------------------	-----------------------------	------------------------------

Describe how source control will be implemented, or justify if not feasible:

SC-2 Storm Drain Stenciling or Signage	<input type="checkbox"/> Yes	<input type="checkbox"/> No	<input type="checkbox"/> N/A
-----------------------------------------------	------------------------------	-----------------------------	------------------------------

Describe how source control will be implemented, or justify if not feasible:

SC-3 Protect Outdoor Materials Storage Areas from Rainfall, Run-On, Runoff, and Wind Dispersal	<input type="checkbox"/> Yes	<input type="checkbox"/> No	<input type="checkbox"/> N/A
-------------------------------------------------------------------------------------------------------	------------------------------	-----------------------------	------------------------------

Describe how source control will be implemented, or justify if not feasible:

SC-4 Protect Materials Stored in Outdoor Work Areas from Rainfall, Run-On, Runoff, and Wind Dispersal	<input type="checkbox"/> Yes	<input type="checkbox"/> No	<input type="checkbox"/> N/A
--------------------------------------------------------------------------------------------------------------	------------------------------	-----------------------------	------------------------------

Describe how source control will be implemented, or justify if not feasible:

Source Control Requirement	Applied?		
SC-5 Protect Trash Storage Areas from Rainfall, Run-On, Runoff, and Wind Dispersal	<input type="checkbox"/> Yes	<input type="checkbox"/> No	<input type="checkbox"/> N/A
Describe how source control will be implemented, or justify if not feasible:			
SC-6 Additional BMPs Based on Potential Sources of Runoff Pollutants (must answer for each source listed below) <ul style="list-style-type: none"> <input type="checkbox"/> On-site storm drain inlets <input type="checkbox"/> Interior floor drains and elevator shaft sump pumps <input type="checkbox"/> Interior parking garages <input type="checkbox"/> Need for future indoor & structural pest control <input type="checkbox"/> Landscape/Outdoor Pesticide Use <input type="checkbox"/> Pools, spas, ponds, decorative fountains, and other water features <input type="checkbox"/> Food service <input type="checkbox"/> Refuse areas <input type="checkbox"/> Industrial processes <input type="checkbox"/> Outdoor storage of equipment or materials <input type="checkbox"/> Vehicle and Equipment Cleaning <input type="checkbox"/> Vehicle/Equipment Repair and Maintenance <input type="checkbox"/> Fuel Dispensing Areas <input type="checkbox"/> Loading Docks <input type="checkbox"/> Fire Sprinkler Test Water <input type="checkbox"/> Miscellaneous Drain or Wash Water <input type="checkbox"/> Plazas, sidewalks, and parking lots 	<input type="checkbox"/> Yes <input type="checkbox"/> Yes <input type="checkbox"/> Yes <input type="checkbox"/> Yes <input type="checkbox"/> Yes <input type="checkbox"/> Yes <input type="checkbox"/> Yes <input type="checkbox"/> Yes <input type="checkbox"/> Yes <input type="checkbox"/> Yes <input type="checkbox"/> Yes <input type="checkbox"/> Yes <input type="checkbox"/> Yes <input type="checkbox"/> Yes <input type="checkbox"/> Yes <input type="checkbox"/> Yes <input type="checkbox"/> Yes	<input type="checkbox"/> No <input type="checkbox"/> No <input type="checkbox"/> No <input type="checkbox"/> No <input type="checkbox"/> No <input type="checkbox"/> No <input type="checkbox"/> No <input type="checkbox"/> No <input type="checkbox"/> No <input type="checkbox"/> No <input type="checkbox"/> No <input type="checkbox"/> No <input type="checkbox"/> No <input type="checkbox"/> No <input type="checkbox"/> No <input type="checkbox"/> No <input type="checkbox"/> No	<input type="checkbox"/> N/A <input type="checkbox"/> N/A <input type="checkbox"/> N/A <input type="checkbox"/> N/A <input type="checkbox"/> N/A <input type="checkbox"/> N/A <input type="checkbox"/> N/A <input type="checkbox"/> N/A <input type="checkbox"/> N/A <input type="checkbox"/> N/A <input type="checkbox"/> N/A <input type="checkbox"/> N/A <input type="checkbox"/> N/A <input type="checkbox"/> N/A <input type="checkbox"/> N/A <input type="checkbox"/> N/A <input type="checkbox"/> N/A <input type="checkbox"/> N/A
Discussion / justification if SC-6 not implemented. Clearly identify which sources of runoff pollutants are discussed. Justification must be provided for <u>all</u> "No" answers shown above.			

Project Name

(Permit Application Number, e.g. LD13-XXX)

Standard Development Storm Water Quality Management Plan

Page XX

Company Name

Project Identification

Project Name

Permit Application Number

Site Design BMPs

All development projects must implement site design BMPs SD-1 through SD-8, unless justification is provided by qualified design professional. See Chapter 4 and Appendix E of the Model BMP Design Manual for information to implement site design BMPs shown in this checklist.

- Answer each category below pursuant to the following, and provide description.
- "Yes" means the project will implement the site design BMP as described in Chapter 4 and/or Appendix E of the Model BMP Design Manual.
 - "No" means the BMP is applicable to the project but it is not feasible to implement.
 - "N/A" means the BMP is not applicable at the project site because the project does not include the feature that is addressed by the BMP (e.g., the project site has no existing natural areas to conserve).

Site Design Requirement	Applied?		
-------------------------	----------	--	--

SD-1 Maintain Natural Drainage Pathways and Hydrologic Features	<input type="checkbox"/> Yes	<input type="checkbox"/> No	<input type="checkbox"/> N/A
------------------------------------------------------------------------	------------------------------	-----------------------------	------------------------------

Describe how site design will be implemented, or justify if not feasible:

SD-2 Conserve Natural Areas, Soils, and Vegetation	<input type="checkbox"/> Yes	<input type="checkbox"/> No	<input type="checkbox"/> N/A
-----------------------------------------------------------	------------------------------	-----------------------------	------------------------------

Describe how site design will be implemented, or justify if not feasible:

SD-3 Minimize Impervious Area	<input type="checkbox"/> Yes	<input type="checkbox"/> No	<input type="checkbox"/> N/A
--------------------------------------	------------------------------	-----------------------------	------------------------------

Describe how site design will be implemented, or justify if not feasible:

SD-4 Minimize Soil Compaction	<input type="checkbox"/> Yes	<input type="checkbox"/> No	<input type="checkbox"/> N/A
--------------------------------------	------------------------------	-----------------------------	------------------------------

Describe how site design will be implemented, or justify if not feasible:

SD-5 Impervious Area Dispersion	<input type="checkbox"/> Yes	<input type="checkbox"/> No	<input type="checkbox"/> N/A
----------------------------------------	------------------------------	-----------------------------	------------------------------

Describe how site design will be implemented, or justify if not feasible:

Form 4 Page 2 of 2			
Site Design Requirement	Applied?		
SD-6 Runoff Collection	<input type="checkbox"/> Yes	<input type="checkbox"/> No	<input type="checkbox"/> N/A
Describe how site design will be implemented, or justify if not feasible:			
SD-7 Landscaping with Native or Drought Tolerant Species	<input type="checkbox"/> Yes	<input type="checkbox"/> No	<input type="checkbox"/> N/A
Describe how site design will be implemented, or justify if not feasible:			
SD-8 Harvesting and Using Precipitation	<input type="checkbox"/> Yes	<input type="checkbox"/> No	<input type="checkbox"/> N/A
Describe how site design will be implemented, or justify if not feasible:			

Project Name

(Permit Application Number, e.g. LD13-XXX)

Standard Development Storm Water Quality Management Plan

Page XX

Company Name

Form 5 - Summary of PDP Structural Pollutant Control and Hydromodification Management BMPs (PDPs)	City of Vista BMP Design Manual
Project Identification	
Project Name	
Permit Application Number	
PDP Structural BMPs	
<p>All PDPs must implement structural BMPs for storm water pollutant control (see Chapter 5 of the BMP Design Manual). Selection of PDP structural BMPs for storm water pollutant control must be based on the selection process described in Chapter 5. PDPs subject to hydromodification management requirements must also implement structural BMPs for flow control for hydromodification management (see Chapter 6 of the BMP Design Manual). Both storm water pollutant control and flow control for hydromodification management can be achieved within the same structural BMP(s).</p>	
<p>PDP structural BMPs must be verified by the local jurisdiction at the completion of construction. This may include requiring the project owner or project owner's representative and engineer of record to certify construction of the structural BMPs (see Section 1.12 of the BMP Design Manual). PDP structural BMPs must be maintained into perpetuity, and the local jurisdiction must confirm the maintenance (see Section 7 of the BMP Design Manual).</p>	
<p>Use this form to provide narrative description of the general strategy for structural BMP implementation at the project site in the box below. Then complete the PDP structural BMP summary information sheet (page 3 of this form) for each structural BMP within the project (copy the BMP summary information page as many times as needed to provide summary information for each individual structural BMP).</p>	
<p>Describe the general strategy for structural BMP implementation at the site. This information must describe how the steps for selecting and designing storm water pollutant control BMPs presented in Section 5.1 of the BMP Design Manual were followed, and the results (type of BMP selected). For projects requiring hydromodification flow control BMPs, indicate whether pollutant control and flow control BMPs are integrated or separate structures.</p>	

Project Name

(Permit Application Number, e.g. LD13-XXX)

Standard Development Storm Water Quality Management Plan

Page XX

Company Name

(Page reserved for continuation of description of general strategy for structural BMP implementation at the site)

(Continued from page 1)

Project Name

(Permit Application Number, e.g. LD13-XXX)

Standard Development Storm Water Quality Management Plan

Page XX

Company Name

SWQMP ATTACHMENT 1

POLLUTANT CONTROLS: Support Documentation & Checklist

Each of the attachments indicated below should be considered for inclusion with the SWQMP. Use this checklist to indicate which attachments are included behind this coversheet.

Attachment Sequence	Contents	SWQMP Inclusion Requirement	Checklist
Attachment 1a	Drainage Management Area (DMA) Exhibit See DMA Exhibit Checklist on next page.	Required	<input type="checkbox"/> Included
Attachment 1b	Tabular Summary of DMAs Showing DMA ID matching DMA Exhibit, DMA Area, and DMA Type* *Provide table in this Attachment OR on DMA Exhibit in Attachment 1a	Required	<input type="checkbox"/> Included on DMA Exhibit in Attachment 1a <input type="checkbox"/> Included as Attachment 1b, separate from DMA Exhibit
Attachment 1c	Form 6, Harvest and Use Feasibility Screening Checklist Refer to Appendix B.3-1 of the BMP Design Manual to complete Form 6.	Required, unless the entire project will utilize Infiltration BMPs	<input type="checkbox"/> Included <input type="checkbox"/> Not included because the entire project will use Infiltration BMPs
Attachment 1d	Form I-8, Categorization of Infiltration Feasibility Condition Refer to Appendices C and D of the <i>BMP Design Manual</i> to complete Form I-8.	Required, unless the project will utilize Harvest and Use BMPs	<input type="checkbox"/> Included <input type="checkbox"/> Not included because the entire project will use Harvest and Use BMPs
Attachment 1e	Pollutant Control BMP Design Worksheets / Calculations Refer to Appendices B and E of the BMP Design Manual for structural pollutant control BMP design guidelines	Required	<input type="checkbox"/> Included

DMA Exhibit Checklist and Tabular Summary of DMAs

Provide a map of project site titled “DMA Exhibit”, which must identify the following elements:

- Underlying hydrologic soil group
- Approximate depth to groundwater
- Existing natural hydrologic features (watercourses, seeps, springs, wetlands, etc.)
- Critical coarse sediment yield areas to be protected
- Existing topography and impervious areas
- Existing and proposed site drainage network and storm drain structures
- Proposed connections to offsite drainage
- Proposed demolition
- Proposed grading
- Proposed impervious features
- Proposed design features and surface treatments used to minimize imperviousness
- Drainage management area (DMA) boundaries
- DMA identification numbers (DMA ID)
- DMA areas (square footage or acreage)
- DMA type (Drains to BMP, Self-mitigating, De Minimis, or Self-retaining)
- Potential pollutant source areas and corresponding required source controls (see Chapter 4, Appendix E.1, and Form 2)
- Proposed Structural BMPs (location, type, and size/detail)

The template tabular summary below may be used on the DMA Exhibit to address many of the elements identified above. An example is provided.

DMA ID	DMA Surface Type (roof, street, etc.)	DMA Area (sq.ft.)	DMA Type ¹	Proposed Structural BMP Type ²	Structural BMP ID	Structural BMP Area ³
1	Asphalt street	8,000 sq.ft.	Drains to BMP	Bioretention	BMP 1	320 sq.ft.

¹ DMA Type can only be: 1) Drains to BMP, 2) Self-mitigating, 3) De Minimis, or 4) Self-retaining

² BMP Type must be consistent with terminology in this BMP Design Manual and/or CASQA Fact Sheets

³ Structural BMP Area is the final facility construction size, typically presented as an area (sq.ft.)

NOTE: We may also suggest a table like this be used as well for bioretention facilities (as applicable):

BMP ID	BMP Area	Gravel Depth	Media Depth	Total Depth	Orifice Elevation	Orifice Size	Orifice Count	Ponding depth (surface to riser)

Project Name

(Permit Application Number, e.g. LD13-XXX)

Standard Development Storm Water Quality Management Plan

Company Name

Page XX

Instructions for PDP WQTR Attachment 1.b Tabular Summary of Drainage Management Areas (DMAs) and Design Capture Volume (DCV) Calculations
Use 'Data Sheet' (included in this Workbook) for data entry

Data Sheet Column ID	Data Sheet Column Header	Instructions
A	DMA ID	Provide DMA identification number matching the DMA exhibit
B	DMA Area, A (ft ²)	Provide DMA Area in square feet
C	Hydrologic Soil Group (A, B, C, or D)	Provide DMA Hydrologic Soil Group (A, B, C, or D)
D	Post-Project Surface Type From Table B.1-1	Provide DMA Post-Project Surface Type From Table B.1-1 of BMP Design Manual
E	Post-Project Surface Runoff Factor, C From Table B.1-1	Provide DMA Post-Project Surface Runoff Factor From Table B.1-1 of BMP Design Manual
F	DMA Excluded from Pollutant Control Design Capture Volume (DCV) Calculations in Accordance with BMP Design Manual Chapter 5.2? (YES / NO)	Indicate YES or NO (see Chapter 5.2 of the BMP Design Manual for DMAs that can be excluded from pollutant control DCV calculations) For 'NO' answer, continue to column G. For 'YES' answer, indicate basis of exclusion (e.g., 'YES, self-mitigating'). PDP WQTR must include relevant calculations for DMAs excluded from DCV calculations when applicable (e.g., self-retaining DMAs via Qualifying Site Design BMPs require backup calculations for ratios of site area requiring volume reduction:site area promoting volume reduction). For 'YES' answer in this column, do not fill Columns G to M. Skip to Column N and enter 'NO' in Column N.
G	Un-Adjusted DCV (ft ³)	Provide un-adjusted DCV in cubic feet (see Appendix B.1 of the BMP Design Manual) Un-adjusted DCV (cubic feet) = Runoff Factor (unitless) x 85th Percentile Precipitation (feet) x DMA Area (square feet) Note: 85th Percentile Precipitation presented in Figure B.1-1 is reported in inches - convert to feet for DCV calculation.
H	DCV Reduction Through Site Design BMPs Applied? (YES / NO)	Indicate YES or NO (see Appendix B.2 of the BMP Design Manual for adjustments to reduce DCV through site design BMPs) For 'NO' answer, continue to Column I and copy un-adjusted DCV from Column G to Column I. For 'YES' answer, indicate type of adjustment and relevant Site Design Fact Sheet (SD-1, 5, 6A, 6B, or 8) (e.g., 'YES, SD-5 Impervious Area Dispersion'). PDP WQTR must include relevant calculations for adjustments. Continue to Column I and provide adjusted DCV.
I	Site Design Adjusted DCV (ft ³)	Provide DCV adjusted for site design BMPs If no adjustments are applicable, then Column I = Column G.
J	Retention BMPs Implemented? (YES / NO)	Indicate YES or NO For 'YES' answer, indicate type of retention BMP (e.g., 'YES, Infiltration'). PDP WQTR must include relevant feasibility worksheet and calculations. For 'NO' answer, PDP WQTR must include both Infiltration Feasibility AND Harvest & Use Feasibility Worksheets (Forms 5 and 6).
K	DCV Remaining After Retention BMPs Implemented (ft ³)	Provide DCV remaining after implementation of retention BMPs. If no retention BMPs implemented, copy DCV from column I and continue to Column L. if remaining DCV after implementation of retention BMPs > 0, continue to Column L. If remaining DCV after implementation of retention BMPs = 0, go to Column N, and Column N = NO.
L	Biofiltration BMPs Implemented? (YES / NO)	Indicate YES or NO For 'YES' answer, PDP WQTR must include relevant calculations. For 'NO' answer, PDP WQTR must describe reason for infeasibility.
M	DCV Remaining After Biofiltration BMPs Implemented (ft ³)	Provide DCV remaining after implementation of biofiltration BMPs. If no biofiltration BMPs, provide DCV from Column K, then Column N = YES if remaining DCV > 0, then Column N = YES if remaining DCV = 0 then Column N = NO
N	Offsite Alternative Compliance and Onsite Flow-Thru Treatment Control BMPs Required? (YES / NO)	Offsite Alternative Compliance and Onsite Flow-Thru Treatment Control BMPs will be required if there is any remaining DCV in column M (if column M > 0)

SWQMP ATTACHMENT 2

HYDROMODIFICATION MANAGEMENT CONTROLS: Support Documentation & Checklist

Check this box if the project is exempt from PDP hydromodification management requirements.

Each of the attachments indicated below should be considered for inclusion with the SWQMP. Use this checklist to indicate which attachments are included behind this coversheet.

Attachment Sequence	Contents	SWQMP Inclusion Requirement	Checklist
Attachment 2a	Hydromodification Management Exhibit	Required	<input type="checkbox"/> Included See Hydromodification Management Exhibit Checklist on the back of this Attachment cover sheet.
Attachment 2b	Management of Critical Coarse Sediment Yield Areas See Section 6.2 of the BMP Design Manual.	Exhibit – Required* Analyses – As Applicable *Exhibit must show where Coarse Sediment Yield Areas are relative to project site.	<input type="checkbox"/> Exhibit showing project drainage boundaries marked on WMAA Critical Coarse Sediment Yield Area Map Analyses, as applicable, for Critical Coarse Sediment Yield Area Determination, per BMP Design Manual: <input type="checkbox"/> 6.2.1 Verification of Geomorphic Landscape Units Onsite <input type="checkbox"/> 6.2.2 Downstream Systems Sensitivity to Coarse Sediment <input type="checkbox"/> 6.2.3 Optional Additional Analysis of Potential Critical Coarse Sediment Yield Areas Onsite
Attachment 2c	Geomorphic Assessment of Receiving Channels See Section 6.3.4 of the BMP Design Manual.	Optional	<input type="checkbox"/> Not performed <input type="checkbox"/> Included <input type="checkbox"/> Submitted as separate stand-alone document
Attachment 2d	Flow Control Facility Design, including Structural BMP Drawdown Calculations and Overflow Design Summary	Required	<input type="checkbox"/> Included <input type="checkbox"/> Submitted as separate stand-alone document

Project Name

(Permit Application Number, e.g. LD13-XXX)

Standard Development Storm Water Quality Management Plan

Page XX

Company Name

Attachment Sequence	Contents	SWQMP Inclusion Requirement	Checklist
	See Chapter 6 and Appendix G of the BMP Design Manual		
Attachment 2e	Vector Control Plan	As Applicable	<input type="checkbox"/> Included <input type="checkbox"/> Not required because BMPs will drain in less than 96 hours

Use this checklist to ensure the required information has been included on the Hydromodification Management Exhibit:

The Hydromodification Management Exhibit must identify:

- Underlying hydrologic soil group
- Approximate depth to groundwater
- Existing natural hydrologic features (watercourses, seeps, springs, wetlands)
- Critical coarse sediment yield areas to be protected
- Existing topography
- Existing and proposed site drainage network and connections to drainage offsite
- Proposed grading
- Proposed impervious features
- Proposed design features and surface treatments used to minimize imperviousness
- Point(s) of Compliance (POC) for Hydromodification Management
- Existing and proposed drainage boundary and drainage area to each POC (when necessary, create separate exhibits for pre-development and post-project conditions)
- Structural BMPs for hydromodification management (identify location, type of BMP, and size/detail)

Project Name

(Permit Application Number, e.g. LD13-XXX)

Standard Development Storm Water Quality Management Plan

Page XX

Company Name

ATTACHMENT 3

STRUCTURAL BMP MAINTENANCE: Support Documentation & Checklist

Each of the attachments indicated below should be considered for inclusion with the SWQMP. Use this checklist to indicate which attachments are included behind this coversheet.

Attachment Sequence	Contents	SWQMP Inclusion Requirement	Checklist
Attachment 3a	Structural BMP Maintenance Thresholds and Actions	Required	<input type="checkbox"/> Included See Structural BMP Maintenance Information Checklist on the back of this Attachment cover sheet.
Attachment 3b	Draft Maintenance Agreement (when applicable)	Required	<input type="checkbox"/> Included <input type="checkbox"/> Not Applicable

ATTACHMENT 4 REQUIREMENTS FOR BMP PLANS

Use this checklist to ensure project BMP construction plans submitted for review include necessary information for storm drain improvements.

Plans for construction of the project (grading plans, improvement plans, and landscaping plans, as applicable) must show all permanent site design, source control, and structural BMPs, and must conform with project design features identified in the PDP SWQMP.

On their own plan sheets, project construction plans shall clearly illustrate all storm drain improvements, features, and structural BMPs. Storm drain construction plan sheets must, at minimum, include the following:

- Identification, count, and location of Source Control BMPs.
- Identification, count, and location of Site Design BMPs.
- Identification, count, and construction specifications of Pollution Control BMPs.
- Identification, count, and construction specifications of Hydromodification Management BMPs.
- Identification, count, and construction specifications of all storm drain facilities or structures (including but not limited to pipe, inlets, outlets, manholes, cleanouts, flow dissipaters, culverts, BMPs, etc.).
- Identification and location of natural water features (waterways, ditches, wetlands, ponds, etc.).
- Grading, drainage, and draining management areas (DMAs), consistent with the SWQMP.
- Identification of all point(s) of discharge, including overflow routes for storm water in event of structural BMP failure or rainfall that exceeds BMP design.
- Flow direction from impervious surfaces, from point of concentration (e.g., roof drains, curb cuts, pipe inlets/outlets) to final approved point of discharge.
- Construction specifications, and plan and profile details for each structural BMP on site. 'Typical' drawings may only be used for structural BMPs with similar shape and design.
- A statement indicating: *"Stormwater BMPs on this project are designed for compliance with Local, State, and Federal water quality requirements. BMP design must not be changed without prior approval by the design engineer and City of Vista. Additional reports, documents, or designs will be required with implementation of changes."*

Project Name

(Permit Application Number, e.g. LD13-XXX)

Standard Development Storm Water Quality Management Plan

Page XX

Company Name

Appendix

B

CITY OF VISTA BMP DESIGN MANUAL

Storm Water Pollutant Control Hydrologic Calculations and Sizing Methods

February 2016

Appendix B Storm Water Pollutant Control Hydrologic Calculations and Sizing Methods

Table of Contents:

- B.1. DCV
- B.2. Adjustments to Account for Site Design BMPs
- B.3. Harvest and Use BMPs
- B.4. Infiltration BMPs
- B.5. Biofiltration BMPs
- B.6. Flow-Through Treatment Control BMPs (for use with Alternative Compliance)

Appendix B: Storm Water Pollutant Control Hydrologic Calculations and Sizing Methods

B.1 DCV

DCV is defined as the volume of storm water runoff resulting from the 85th percentile, 24-hr storm event. The following hydrologic method shall be used to calculate the DCV:

$$DCV = C \times d \times A \times 43,560 \text{ sf/ac} \times 1/12 \text{ in/ft}$$

$$DCV = 3,630 \times C \times d \times A$$

Where:

DCV = Design Capture Volume in cubic feet

C = Runoff factor (unitless); refer to section B.1.1

d = 85th percentile, 24-hr storm event rainfall depth (inches), refer to section B.1.3

A = Tributary area (acres) which includes the total area draining to the BMP, including any offsite or onsite areas that comingles with project runoff and drains to the BMP. Refer to Chapter 3, Section 3.3.3 for additional guidance. Street redevelopment projects consult section 1.4.3.

B.1.1 Runoff Factor

Estimate the area weighted runoff factor for the tributary area to the BMP using runoff factor (from Table B.1-1) and area of each surface type in the tributary area and the following equation:

$$C = \frac{\sum C_x A_x}{\sum A_x}$$

Where:

C_x = Runoff factor for area X

A_x = Tributary area X (acres)

These runoff factors apply to areas receiving direct rainfall only. For conditions in which runoff is routed onto a surface from an adjacent surface, see Section B.2 for determining composite runoff factors for these areas.

Table B.1-1: Runoff factors for surfaces draining to BMPs – Pollutant Control BMPs

Surface	Runoff Factor
Roofs ¹	0.90
Concrete or Asphalt ¹	0.90
Unit Pavers (grouted) ¹	0.90
Decomposed Granite	0.30
Cobbles or Crushed Aggregate	0.30
Amended, Mulched Soils or Landscape	0.10
Compacted Soil (e.g., unpaved parking)	0.30

1. Surface is considered impervious and could benefit from use of Site Design BMPs and adjustment of the runoff factor per Section B.2.1.

Appendix B: Storm Water Pollutant Control Hydrologic Calculations and Sizing Methods

Surface	Runoff Factor
Natural (A Soil)	0.10
Natural (B Soil)	0.14
Natural (C Soil)	0.23
Natural (D Soil)	0.30

B.1.2 Offline BMPs

Diversion flow rates for offline BMPs shall be sized to convey the maximum flow rate of runoff produced from a rainfall intensity of 0.2 inch of rainfall per hour, for each hour of every storm event. The following hydrologic method shall be used to calculate the diversion flow rate for off-line BMPs:

$$Q = C \times i \times A$$

Where:

Q = Diversion flow rate in cubic feet per second

C = Runoff factor, area weighted estimate using Table B.1

i = Rainfall intensity of 0.2 in/hr

A = Tributary area (acres) which includes the total area draining to the BMP, including any offsite or onsite areas that comingle with project runoff and drain to the BMP. Refer to Chapter 3, Section 3.3.3 for additional guidance. Street redevelopment projects also consult Section 1.4.3.

B.1.3 85th Percentile, 24-Hour Storm Event

The 85th percentile, 24-hour isopluvial map is provided as Figure B.1-1. The rainfall depth to estimate the DCV shall be determined using Figure B.1-1. The methodology used to develop this map is presented below:

B.1.3.1 Gage data and calculation of 85th percentile

The method of calculating the 85th percentile is to produce a list of values, order them from smallest to largest, and then pick the value that is 85 percent of the way through the list. Only values that are capable of producing run off are of interest for this purpose. Lacking a legislative definition of rainfall values capable of producing runoff, Flood Control staff in San Diego County have observed that the point at which significant runoff begins is rather subjective, and is affected by land use type and soil moisture. In highly-urbanized areas, the soil has a high impermeability and runoff can begin with as little as 0.02" of rainfall. In rural areas, soil impermeability is significantly lower and even 0.30" of rain on dry soil will frequently not produce significant runoff. For this reason, San Diego County has chosen to use the more objective method of including all non-zero 24-hour rainfall totals when calculating the 85th percentile. To produce a statistically significant number, only stations with 30 years or greater of daily rainfall records are used.

Appendix B: Storm Water Pollutant Control Hydrologic Calculations and Sizing Methods

B.1.3.2 Mapping the gage data

A collection of 56 precipitation gage points was developed with 85th percentile precipitation values based on multiple years of gage data. A raster surface (grid of cells with values) was interpolated from that set of points. The surface initially did not cover the County's entire jurisdiction. A total of 13 dummy points were added. Most of those were just outside the County boundary to enable the software to generate a surface that covered the entire County. A handful of points were added to enforce a plausible surface. In particular, one point was added in the desert east of Julian, to enforce a gradient from high precipitation in the mountains to low precipitation in the desert. Three points were added near the northern boundary of the County to adjust the surface to reflect the effect of elevation in areas lacking sufficient operating gages.

Several methods of interpolation were considered. The method chosen is named by Environmental Systems Research Institute as the Natural Neighbor technique. This method produces a surface that is highly empirical, with the value of the surface being a product of the values of the data points nearest each cell. It does not produce peaks or valleys of surface based on larger area trends, and is free of artifacts that appeared with other methods.

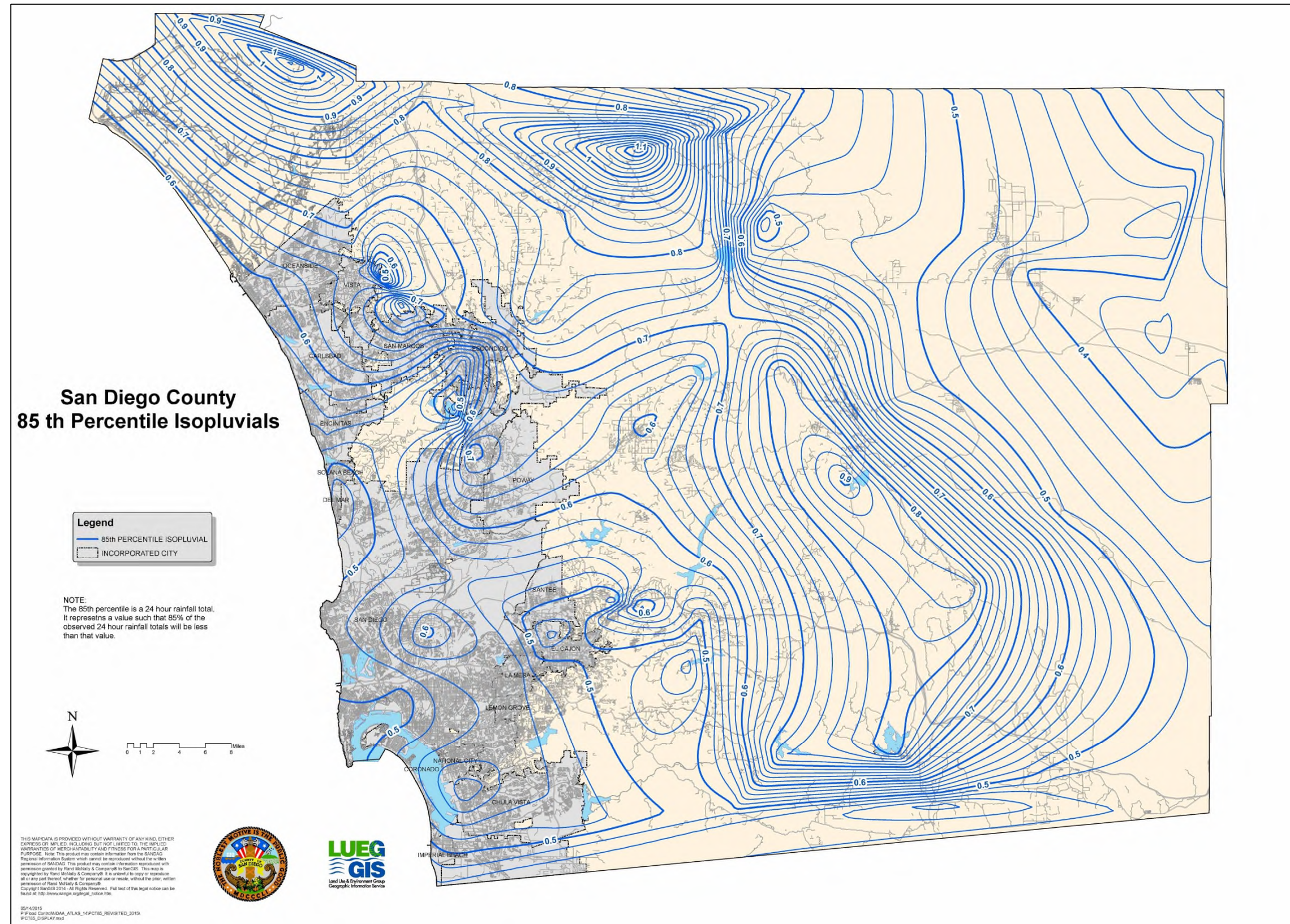

Figure B.1-1: 85th Percentile 24-hour Isopluvial Map

B.2 Adjustments to Account for Site Design BMPs

This section provides methods to adjust the DCV (for sizing pollutant control BMPs) as a result of implementing site design BMPs. The adjustments are provided by one of the following two methods:

- Adjustment to impervious runoff factor
- Adjustment to DCV

B.2.1 Adjustment to Impervious Runoff Factor

When one of the following site design BMPs is implemented the runoff factor of 0.9 for impervious surfaces identified in Table B.1-1 should be adjusted using the factors listed below and an adjusted area weighted runoff factor shall be estimated following guidance from Section B.1.1 and used to calculate the DCV.

- SD-5 Impervious area dispersion
- SD-6A Green roofs
- SD-6B Permeable pavement

B.2.1.1 Impervious area dispersion (SD-5)

Dispersion of impervious areas through pervious areas: The following adjustments are allowed to impervious runoff factors when dispersion is implemented in accordance with the SD-5 fact sheet (Appendix E). Adjustments are only credited up to a 4:1 maximum ratio of impervious to pervious areas. In order to adjust the runoff factor, the pervious area shall have a minimum width of 10 feet and a maximum slope of 5%. Based on the ratio of **impervious area to pervious area** and the hydrologic soil group of the pervious area, the adjustment factor from Table B.2-1 shall be multiplied with the unadjusted runoff factor (Table B.1-1) of the impervious area to estimate the adjusted runoff factor for sizing pollutant control BMPs. The adjustment factors in Table B.2-1 are **only** valid for impervious surfaces that have an unadjusted runoff factor of 0.9.

Table B.2-1: Impervious area adjustment factors that accounts for dispersion

Pervious area hydrologic soil group	Ratio = Impervious area/Pervious area			
	<=1	2	3	4
A	0.00	0.00	0.23	0.36
B	0.00	0.27	0.42	0.53
C	0.34	0.56	0.67	0.74
D	0.86	0.93	0.97	1.00

Appendix B: Storm Water Pollutant Control Hydrologic Calculations and Sizing Methods

Continuous simulation modeling in accordance with Appendix G is required to develop adjustment factors for surfaces that have an unadjusted runoff factor less than 0.9. Approval of adjustment factors for surfaces that have an unadjusted runoff factor less than 0.9 is at the discretion of the City Engineer. The adjustment factors in Table B.2-1 were developed by performing continuous simulations in SWMM with default parameters from Appendix G and impervious to pervious area ratios of 1, 2, 3, and 4. When using adjustment factors from Table B.2-1:

- **Linear interpolation** shall be performed if the impervious to pervious area ratio of the site is in between one of ratios for which an adjustment factor was developed;
- Use adjustment factor for a ratio of 1 when the impervious to pervious area ratio is less than 1; and
- Adjustment factor is not allowed when the impervious to pervious area ratio is greater than 4, when the pervious area is designed as a site design BMP.

Example B.2-1: DMA is comprised of one acre of impervious area that drains to a 0.4 acre hydrologic soil group B pervious area and then the pervious area drains to a BMP. Impervious area dispersion is implemented in the DMA in accordance with SD-5 factsheet. Estimate the adjusted runoff factor for the DMA.

- Baseline Runoff Factor per Table B.1-1 = $[(1*0.9+0.4*0.14)/1.4] = 0.68$.
- Impervious to Pervious Ratio = 1 acre impervious area/ 0.4 acre pervious area = 2.5; since the ratio is 2.5 adjustment can be claimed.
- From Table B.2-1 the adjustment factor for hydrologic soil group B and a ratio of 2 = 0.27; ratio of 3 = 0.42.
- Linear interpolated adjustment factor for a ratio of 2.5 = $0.27 + \{[(0.42 - 0.27)/(3-2)]*(2.5-2)\} = 0.345$.
- Adjusted runoff factor for the DMA = $[(1*0.9*0.345+0.4*0.14)/1.4] = 0.26$.
- Note only the runoff factor for impervious area is adjusted, there is no change made to the pervious area.

B.2.1.2 Green Roofs

When green roofs are implemented in accordance with the SD-6A factsheet the green roof footprint shall be assigned a runoff factor of 0.10 for adjusted runoff factor calculations.

B.2.1.3 Permeable Pavement

When a permeable pavement is implemented in accordance with the SD-6B factsheet and it does not have an impermeable liner and has storage greater than the 85th percentile depth below the underdrain, if an underdrain is present, then the footprint of the permeable pavement shall be assigned a runoff factor of 0.10 for adjusted runoff factor calculations.

Appendix B: Storm Water Pollutant Control Hydrologic Calculations and Sizing Methods

Permeable Pavement can also be designed as a structural BMP to treat run on from adjacent areas. Refer to INF-3 factsheet and Appendix B.4 for additional guidance.

B.2.2 Adjustment to DCV

When the following site design BMPs are implemented the anticipated volume reduction from these BMPs shall be deducted from the DCV to estimate the volume for which the downstream structural BMP should be sized for:

- SD-1: Street trees
- SD-8: Rain barrels

B.2.2.1 Street Trees

Street tree credit volume from tree trenches or boxes (tree BMPs) is a sum of three runoff reduction volumes provided by trees that decrease the required DCV for a tributary area. The following reduction in DCV is allowed per tree based on the mature diameter of the tree canopy, when trees are implemented in accordance with SD-1 factsheet and meet the following criteria:

- Total tree credit volume is less than 0.25DCV of the project footprint and
- Single tree credit volume is less than 400 ft³

Credit for trees that do not meet the above criteria shall be based on the criteria for sizing the tree as a storm water pollutant control BMP in SD-1 fact sheet.

Mature Tree Canopy Diameter (ft.)	Tree Credit Volume (ft ³ /tree)
5	10
10	40
15	100
20	180
25	290
30	420

Basis for the reduction in DCV:

Tree credit volume was estimated based on typical characteristics of street trees as follows:

Appendix B: Storm Water Pollutant Control Hydrologic Calculations and Sizing Methods

It is assumed that each tree and associated trench or box is considered a single BMP, with calculations based on the media storage volume and/or the individual tree within the tree BMP as appropriate. Tree credit volume is calculated as:

$$TCV = TIV + TCIV + TETV$$

Where:

- TCV = Tree credit volume (ft³)
- TIV = Total infiltration volume of all storage layers within tree BMPs (ft³)
- $TCIV$ = Total canopy interception volume of all individual trees within tree BMPs (ft³)
- $TETV$ = Total evapotranspiration volume, sums the media evapotranspiration storage within each tree BMP (ft³)

Total infiltration volume was calculated as the total volume infiltrated within the BMP storage layers. Infiltration volume was assumed to be 20% of the total BMP storage layer volume, the available pore space in the soil volume (porosity – field capacity). Total canopy interception volume was calculated for all street trees within the tributary area as the average interception capacity for the entire mature tree total canopy projection area. Interception capacity was determined to be 0.04 inches for all street tree sizes, an average from the findings published by Breuer et al (2003) for coniferous and deciduous trees. Total evapotranspiration volume is the available evapotranspiration storage volume (field capacity – wilting point) within the BMP storage layer media. TEVT is assumed to be 10% of the minimum soil volume. The minimum soil volume as required by SD-1 fact sheet of 2 cubic feet per unit canopy projection area was assumed for estimating reduction in DCV.

B.2.2.2 Rain Barrels

Rain barrels are containers that can capture rooftop runoff and store it for future use. Credit can be taken for the full rain barrel volume when each barrel volume is smaller than 100 gallons, implemented per SD-8 fact sheet and meet the following criteria:

- Total rain barrel volume is less than 0.25 DCV and
- Landscape areas are greater than 30 percent of the project footprint.

Credit for harvest and use systems that do not meet the above criteria shall be based on the criteria in Appendix B.3 and HU-1 fact sheet.

Appendix B: Storm Water Pollutant Control Hydrologic Calculations and Sizing Methods

Worksheet B.2-1. DCV

Design Capture Volume		Worksheet B-2.1		
1	85 th percentile 24-hr storm depth from Figure B.1-1	d=		inches
2	Area tributary to BMP (s)	A=		acres
3	Area weighted runoff factor (estimate using Appendix B.1.1 and B.2.1)	C=		unitless
4	Street trees volume reduction	TCV=		cubic-feet
5	Rain barrels volume reduction	RCV=		cubic-feet
6	Calculate DCV = $(3630 \times C \times d \times A) - TCV - RCV$	DCV=		cubic-feet

B.3 Harvest and Use BMPs

The purpose of this section is to provide guidance for evaluating feasibility of harvest and use BMPs, calculating harvested water demand and sizing harvest and use BMPs.

B.3.1 Planning Level Harvest and Use Feasibility

Harvest and use feasibility should be evaluated at the scale of the entire project, and not limited to a single DMA. For the purpose of initial feasibility screening, it is assumed that harvested water collected from one DMA could be used within another. Types of non-potable water demand that may apply within a project include:

- Toilet and urinal flushing
- Irrigation
- Vehicle washing
- Evaporative cooling
- Dilution water for recycled water systems
- Industrial processes
- Other non-potable uses

Worksheet B.3-1 provides a screening process for determining the preliminary feasibility for harvest and use BMPs. This worksheet should be completed for the overall project.

Appendix B: Storm Water Pollutant Control Hydrologic Calculations and Sizing Methods

Worksheet B.3-1. Harvest and Use Feasibility Screening

Harvest and Use Feasibility Screening		Worksheet B.3-1
<p>1. Is there a demand for harvested water (check all that apply) at the project site that is reliably present during the wet season?</p> <p><input type="checkbox"/> Toilet and urinal flushing</p> <p><input type="checkbox"/> Landscape irrigation</p> <p><input type="checkbox"/> Other: _____</p>		
<p>2. If there is a demand; estimate the anticipated average wet season demand over a period of 36 hours. Guidance for planning level demand calculations for toilet/urinal flushing and landscape irrigation is provided in Section B.3.2.</p> <p>[Provide a summary of calculations here]</p>		
<p>3. Calculate the DCV using worksheet B-2.1.</p> <p>[Provide a results here]</p>		
<p>3a. Is the 36-hour demand greater than or equal to the DCV?</p> <p align="center">Yes / No ⇒ ↓</p>	<p>3b. Is the 36-hour demand greater than 0.25DCV but less than the full DCV?</p> <p align="center">Yes / No ⇒ ↓</p>	<p>3c. Is the 36-hour demand less than 0.25DCV?</p> <p align="center">Yes ↓</p>
<p>Harvest and use appears to be feasible. Conduct more detailed evaluation and sizing calculations to confirm that DCV can be used at an adequate rate to meet drawdown criteria.</p>	<p>Harvest and use may be feasible. Conduct more detailed evaluation and sizing calculations to determine feasibility. Harvest and use may only be able to be used for a portion of the site, or (optionally) the storage may need to be upsized to meet long term capture targets while draining in longer than 36 hours.</p>	<p>Harvest and use is considered to be infeasible.</p>

B.3.2 Harvested Water Demand Calculation

The following sections provide technical references and guidance for estimating the harvested water demand of a project. These references are intended to be used for the planning phase of a project for feasibility screening purposes.

B.3.2.1 Toilet and Urinal Flushing Demand Calculations

The following guidelines should be followed for computing harvested water demand from toilet and urinal flushing:

- If reclaimed water is planned for use for toilet and urinal flushing, then the demand for harvested storm water is equivalent to the total demand minus the reclaimed water supplied, and should be reduced by the amount of reclaimed water that is available during the wet season.
- Demand calculations for toilet and urinal flushing should be based on the average rate of use during the wet season for a typical year.
- Demand calculations should include changes in occupancy over weekends and around holidays and changes in attendance/enrollment over school vacation periods.
- For facilities with generally high demand, but periodic shut downs (e.g., for vacations, maintenance, or other reasons), a project specific analysis should be conducted to determine whether the long term storm water capture performance of the system can be maintained despite shut downs.
- Such an analysis should consider the statistical distributions of precipitation and demand, most importantly the relationship of demand to the wet seasons of the year.

Table B.3-1 provides planning level demand estimates for toilet and urinal flushing per resident, or employee, for a variety of project types. The per capita use per day is based on daily employee or resident usage. For non-residential types of development, the “visitor factor” and “student factor” (for schools) should be multiplied by the employee use to account for toilet and urinal usage for non-employees using facilities.

Appendix B: Storm Water Pollutant Control Hydrologic Calculations and Sizing Methods

Table B.3-1. Toilet and Urinal Water Usage per Resident or Employee

Land Use Type	Toilet User Unit of Normalization	Per Capita Use per Day		Visitor Factor ⁴	Water Efficiency Factor	Total Use per Resident or Employee
		Toilet Flushing ^{1, 2}	Urinals ³			
Residential	Resident	18.5	NA	NA	0.5	9.3
Office	Employee (non-visitor)	9.0	2.27	1.1	0.5	7 (avg)
Retail	Employee (non-visitor)	9.0	2.11	1.4	0.5	
Schools	Employee (non-student)	6.7	3.5	6.4	0.5	33
Various Industrial Uses (excludes process water)	Employee (non-visitor)	9.0	2	1	0.5	5.5

1 - Based on American Waterworks Association Research Foundation, 1999. Residential End Uses of Water. Denver, CO: AWWARF

2 - Based on use of 3.45 gallons per flush and average number of per employee flushes per subsector, Table D-1 for MWD (Pacific Institute, 2003)

3 - Based on use of 1.6 gallons per flush, Table D-4 and average number of per employee flushes per subsector, Appendix D (Pacific Institute, 2003)

4 - Multiplied by the demand for toilet and urinal flushing for the project to account for visitors. Based on proportion of annual use allocated to visitors and others (includes students for schools; about 5 students per employee) for each subsector in Table D-1 and D-4 (Pacific Institute, 2003)

5 - Accounts for requirements to use ultra-low flush toilets in new development projects; assumed that requirements will reduce toilet and urinal flushing demand by half on average compared to literature estimates. Ultra-low flush toilets are required in all new construction in California as of January 1, 1992. Ultra-low flush toilets must use no more than 1.6 gallons per flush and Ultra low flush urinals must use no more than 1 gallon per flush. Note: If zero flush urinals are being used, adjust accordingly.

B.3.2.2 General Requirements for Irrigation Demand Calculations

The following guidelines should be followed for computing harvested water demand from landscape irrigation:

- If reclaimed water is planned for use for landscape irrigation, then the demand for harvested storm water should be reduced by the amount of reclaimed water that is available during the wet season.
- Irrigation rates should be based on the irrigation demand exerted by the types of landscaping that are proposed for the project, with consideration for water conservation requirements.
- Irrigation rates should be estimated to reflect the average wet season rates (defined as October through April) accounting for the effect of storm events in offsetting harvested water demand. In the absence of a detailed demand study, it should be assumed that irrigation demand is not present during days with greater than 0.1 inches of rain and the subsequent 3-day period. This irrigation shutdown period is consistent with standard practice in land application of wastewater and is applicable to storm water to prevent irrigation from resulting in dry weather

Appendix B: Storm Water Pollutant Control Hydrologic Calculations and Sizing Methods

runoff. Based on a statistical analysis of San Diego County rainfall patterns, approximately 30 percent of wet season days would not have a demand for irrigation.

- If land application of storm water is proposed (irrigation in excess of agronomic demand), then this BMP must be considered to be an infiltration BMP and feasibility screening for infiltration must be conducted. In addition, it must be demonstrated that land application would not result in greater quantities of runoff as a result of saturated soils at the beginning of storm events. Agronomic demand refers to the rate at which plants use water.

The following sections describe methods that should be used to calculate harvested water irrigation demand. While these methods are simplified, they provide a reasonable estimate of potential harvested water demand that is appropriate for feasibility analysis and project planning. These methods may be replaced by a more rigorous project-specific analysis that meets the intent of the criteria above.

B.3.2.2.1 Demand Calculation Method

This method is based on the San Diego Municipal Code Land Development Code Landscape Standards Appendix E which includes a formula for estimating a project's annual estimated total water use based on reference evaporation, plant factor, and irrigation efficiency.

For the purpose of calculating harvested water irrigation demand applicable to the sizing of harvest and use systems, the estimated total water use has been modified to reflect typical wet-season irrigation demand. This method assumes that the wet season is defined as October through April. This method further assumes that no irrigation water will be applied during days with precipitation totals greater than 0.1 inches or within the 3 days following such an event. Based on these assumptions and an analysis of Lake Wohlford, Lindbergh and Oceanside precipitation patterns, irrigation would not be applied during approximately 30 percent of days from October through April.

The following equation is used to calculate the Modified Estimated Total Water Usage:

$$\text{Modified ETWU} = \text{ET}_{\text{Owet}} \times \left[\frac{\sum(\text{PF} \times \text{HA})}{\text{IE}} + \text{SLA} \right] \times 0.015$$

Where:

Modified ETWU = Estimated daily average water usage during wet season

ET_{Owet} = Average reference evapotranspiration from October through April (use 2.8 inches per month, using CIMS Zone 4 from Table G.1-1)

PF = Plant Factor

Appendix B: Storm Water Pollutant Control Hydrologic Calculations and Sizing Methods

Table B.3-2. Planning Level Plant Factor Recommendations

Plant Water Use	Plant Factor	Also Includes
Low	< 0.1 – 0.2	Artificial Turf
Moderate	0.3 – 0.7	
High	0.8 and greater	Water features
Special Landscape Area	1.0	

HA = Hydrozone Area (sq-ft); A section or zone of the landscaped area having plants with similar water needs.

$\Sigma(PF \times HA)$ = The sum of PF x HA for each individual Hydrozone (accounts for different landscaping zones).

IE = Irrigation Efficiency (assume 90 percent for demand calculations)

SLA = Special Landscape Area (sq-ft); Areas used for active and passive recreation areas, areas solely dedicated to the production of fruits and vegetables, and areas irrigated with reclaimed water.

In this equation, the coefficient (0.015) accounts for unit conversions and shut down of irrigation during and for the three days following a significant precipitation event:

$$0.015 = (1 \text{ mo.}/30 \text{ days}) \times (1 \text{ ft.}/12 \text{ in}) \times (7.48 \text{ gal}/\text{cu-ft.}) \times (\text{approximately } 7 \text{ out of } 10 \text{ days with irrigation demand from October through April})$$

B.3.2.2.2 Planning Level Irrigation Demands

To simplify the planning process, the method described above has been used to develop daily average wet season demands for a one-acre irrigated area based on the plant/landscape type. These demand estimates can be used to calculate the drawdown of harvest and use systems for the purpose of LID BMP sizing calculations.

Table B.3-3. Planning Level Irrigation Demand by Plant Factor and Landscape Type

General Landscape Type	36-Hour Planning Level Irrigation Demand (gallons per irrigated acre per 36 hour period)
Hydrozone – Low Plant Water Use	390
Hydrozone – Moderate Plant Water Use	1,470
Hydrozone – High Plant Water Use	2,640
Special Landscape Area	2,640

Appendix B: Storm Water Pollutant Control Hydrologic Calculations and Sizing Methods

B.3.2.3 Calculating Other Harvested Water Demands

Calculations of other harvested water demands should be based on the knowledge of land uses, industrial processes, and other factors that are project-specific. Demand should be calculated based on the following guidelines:

- Demand calculations should represent actual demand that is anticipated during the wet season (October through April).
- Sources of demand should only be included if they are reliably and consistently present during the wet season.
- Where demands are substantial but irregular, a more detailed analysis should be conducted based on a statistical analysis of anticipated demand and precipitation patterns.

B.3.3 Sizing Harvest and Use BMPs

Sizing calculations shall demonstrate that one of two equivalent performance standards is met:

1. Harvest and use BMPs are sized to drain the tank in 36 hours following the end of rainfall. The size of the BMP is dependent on the demand (Section B.3.2) at the site.
2. Harvest and use BMP is designed to capture at least 80 percent of average annual (long term) runoff volume.

It is rare cisterns can be sized to capture the full DCV and use this volume in 36 hours. So when using Worksheet B.3-1 if it is determined that harvest and use BMP is feasible then the BMP should be sized to the estimated 36-hour demand.

B.4 Infiltration BMPs

Sizing calculations shall demonstrate that one of two equivalent performance standards is met:

1. The BMP or series of BMPs captures the DCV and infiltrates this volume fully within 36 hours following the end of precipitation. This can be demonstrated through the Simple Method (Section B.4.1).
2. The BMP or series of BMPs infiltrates at least 80 percent of average annual (long term) runoff volume. This can be demonstrated using the percent capture method (Section B.4.2), through reporting of output from the San Diego Hydrology Model, or through other continuous simulation modeling meeting the criteria in Appendix G, as acceptable to the City Engineer. This method is **not** applicable for sizing biofiltration BMPs.

The methods to show compliance with these standards are provided in the following sections.

B.4.1 Simple Method

Stepwise Instructions:

1. Compute DCV using Worksheet B.4-1
2. Estimate design infiltration rate using Worksheet D.5-1
3. Design BMP(s) to ensure that the DCV is fully retained (i.e., no surface discharge during the design event) and the stored effective depth draws down in no longer than 36 hours.

Worksheet B.4-1: Simple Sizing Method for Infiltration BMPs

Simple Sizing Method for Infiltration BMPs		Worksheet B.4-1		
1	DCV (Worksheet B-2.1)	DCV=		cubic-feet
2	Estimated design infiltration rate (Worksheet D.5-1)	$K_{\text{design}}=$		in/hr
3	Available BMP surface area	$A_{\text{BMP}}=$		sq-ft
4	Average effective depth in the BMP footprint (DCV/A_{BMP})	$D_{\text{avg}}=$		feet
5	Drawdown time, T ($D_{\text{avg}} * 12 / K_{\text{design}}$)	T=		hours
6	Provide alternative calculation of drawdown time, if needed.			

Notes:

- Drawdown time must be less than 36 hours. This criterion was set to achieve average annual capture of 80% to account for back to back storms (See rationale in Section B.4.3). In order to use a different drawdown time, BMPs should be sized using the percent capture method (Section B.4.2).
- The average effective depth calculation should account for any aggregate/media in the BMP. For example, 4 feet of stone at a porosity of 0.4 would equate to 1.6 feet of effective depth.
- This method may overestimate drawdown time for BMPs that drain through both the bottom and walls of the system. BMP specific calculations of drawdown time may be provided that account for BMP-specific geometry.

B.4.2 Percent Capture Method

This section describes the recommended method of sizing volume-based BMPs to achieve the 80 percent capture performance criterion. This method has a number of potential applications for sizing BMPs, including:

- Use this method when a BMP can draw down in less than 36 hours and it is desired to demonstrate that 80 percent capture can be achieved using a BMP volume smaller than the DCV.
- Use this method to determine how much volume (greater than the DCV) must be provided to achieve 80 percent capture when the drawdown time of the BMP exceeds 36 hours.
- Use this method to determine how much volume should be provided to achieve 80 percent capture when upstream BMP(s) have achieved some capture, but have not achieved 80 percent capture.

By nature, the percent capture method is an iterative process that requires some initial assumptions about BMP design parameters and subsequent confirmation that these assumptions are valid. For example, sizing calculations depend on the assumed drawdown time, which depends on BMP depth, which may in turn need to be adjusted to provide the required volume within the allowable footprint. In general, the selection of reasonable BMP design parameters in the first iteration will result in minimal required additional iterations. Figure B.4-1 presents the nomograph for use in sizing retention BMPs in San Diego County.

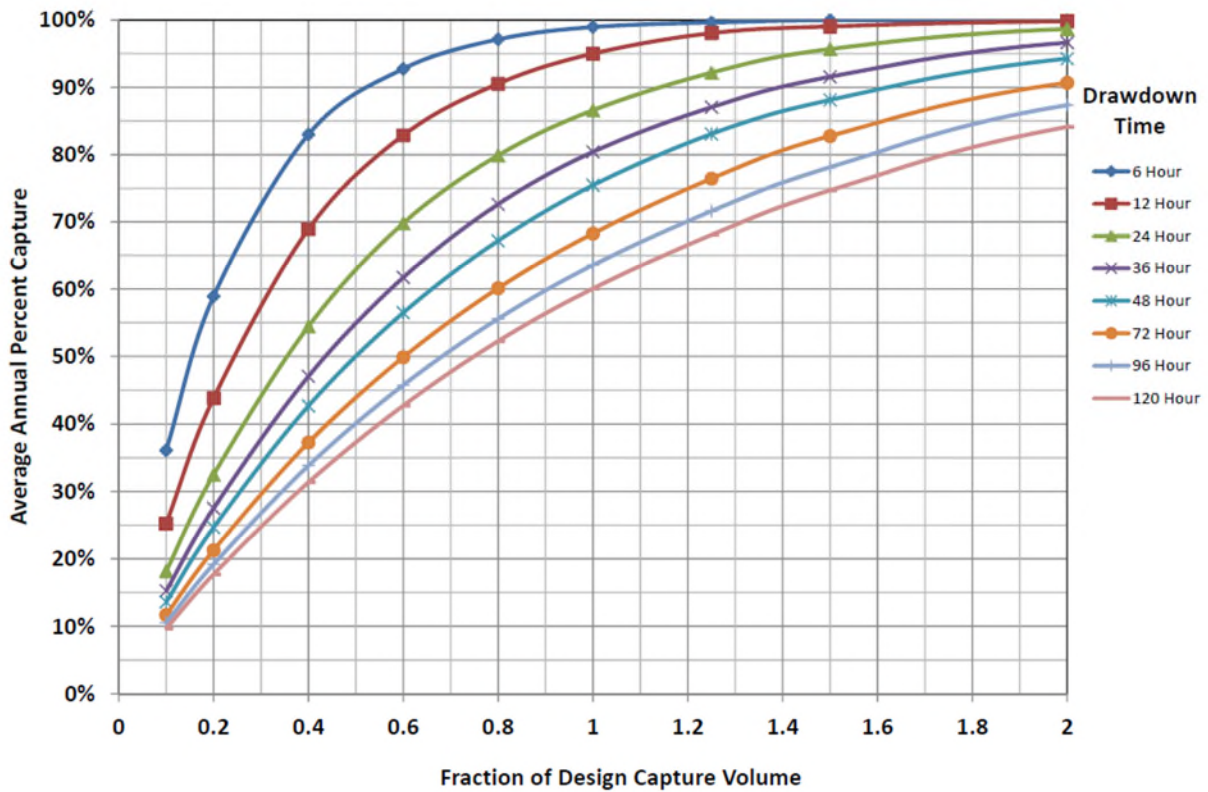

Figure B.4-1: Percent Capture Nomograph

Appendix B: Storm Water Pollutant Control Hydrologic Calculations and Sizing Methods

B.4.2.1 Stepwise Instructions for sizing a single BMP:

1. Estimate the drawdown time of the proposed BMP by estimating the design infiltration rate (Worksheet D.5-1) and accounting for BMP dimensions/geometry. See the applicable BMP Fact Sheet for specific guidance on how to convert BMP geometry to estimated drawdown time.
2. Using the estimated drawdown time and the nomograph from Figure B.4-1 locate where the line corresponding to the estimated drawdown time intersects with 80 percent capture. Pivot to the X axis and read the fraction of the DCV that needs to be provided in the BMP to achieve this level of capture.
3. Calculate the DCV using Worksheet B.2-1.
4. Multiply the result of Step 2 by the DCV (Step 3). This is the required BMP design volume.
5. Design the BMP to retain the required volume, and confirm that the drawdown time is no more than 25 percent greater than estimated in Step 1. If the computed drawdown time is greater than 125 percent of the estimated drawdown, then return to Step 1 and revise the initial drawdown time assumption.

See the respective BMP facts sheets for BMP-specific instructions for the calculation of volume and drawdown time. The above method can also be used to size and/or evaluate the performance of other retention BMPs (evapotranspiration, harvest and use) that have a drawdown rate that can be approximated as constant throughout the year or over the wet season. In order to use this method for other retention BMPs, drawdown time in Step 1 will need to be evaluated using an applicable method for the type of BMP selected. After completing Step 1 continue to Step 2 listed above.

Example B.4.2.1 Percent Capture Method for Sizing a Single BMP:

Given:
<ul style="list-style-type: none">• Estimated drawdown time: 72 Hours• DCV: 3000 ft³
Required:
<ul style="list-style-type: none">• Determine the volume required to achieve 80 percent capture.
Solution:
<ol style="list-style-type: none">1. Estimated drawdown time = 72 Hours2. Fraction of DCV required = 1.353. DCV = 3000 ft³ (Given for this example; To be estimated using Worksheet B.2-1)4. Required BMP volume = 1.35 x 3000 = 4050 ft³5. Design BMP and confirm drawdown Time is \leq 90 Hours (72 Hours +25%)

Example B.4.2.1 Continued:

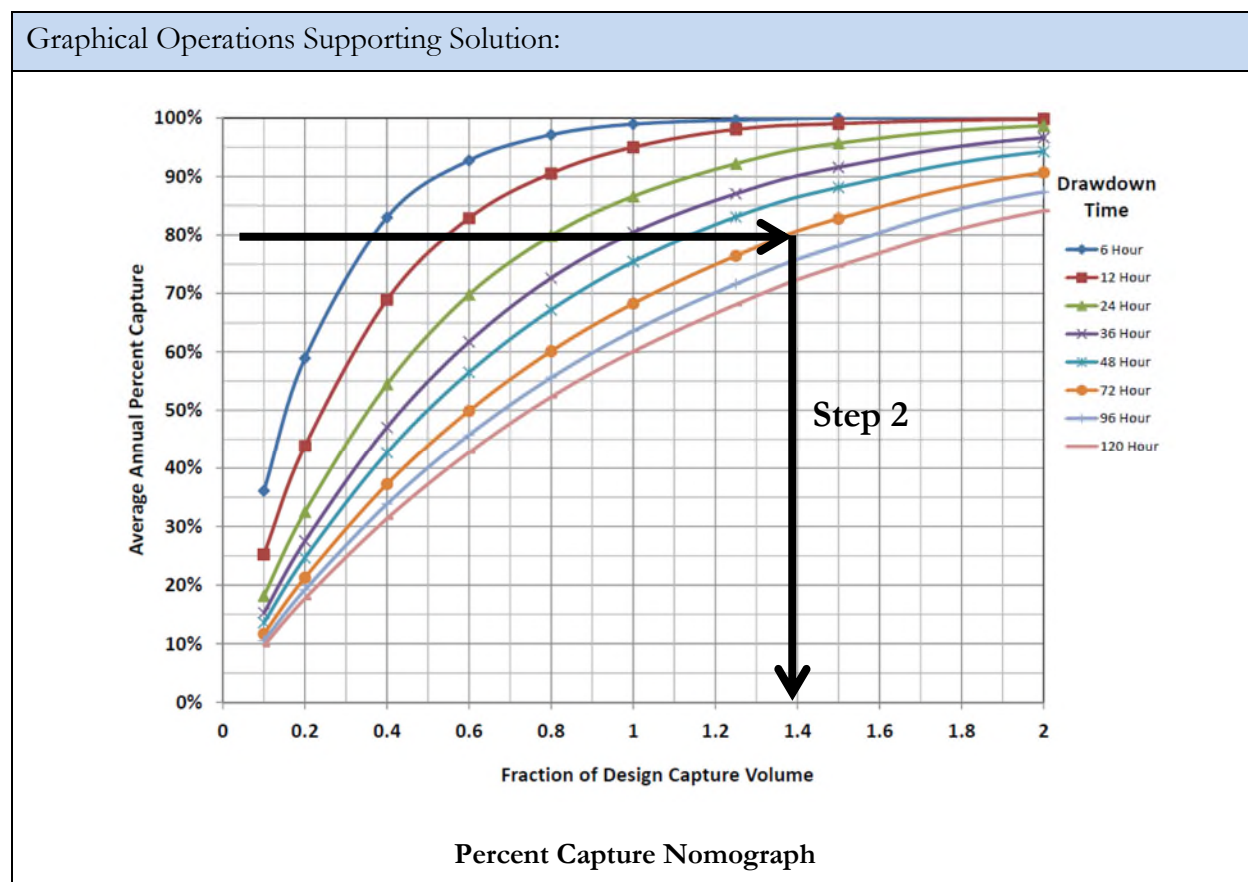

B.4.2.2 Stepwise Instructions for sizing BMPs in series:

For projects where BMPs in series have to be implemented to meet the performance standard the following stepwise procedure shall be used to size the downstream BMP to achieve the 80 percent capture performance criterion:

1. Using the upstream BMP parameters (volume and drawdown time) estimate the average annual capture efficiency achieved by the upstream BMP using the nomograph.
2. Estimate the drawdown time of the proposed downstream BMP by estimating the design infiltration rate (Worksheet D.5-1) and accounting for BMP dimensions/geometry. See the applicable BMP Fact Sheet for specific guidance on how to convert BMP geometry to estimated drawdown time. Use the nomograph and locate where the line corresponding to the estimated drawdown time intersects with 80 percent capture. Pivot to the horizontal axis and read the fraction of the DCV that needs to be provided in the BMP. This is referred to as X_1 .
3. Trace a horizontal line on the nomograph using the capture efficiency of the upstream BMP estimated in Step 1. Find where the line traced intersects with the drawdown time of the downstream BMP (Step 2). Pivot and read down to the horizontal axis to yield the fraction of the DCV already provided by the upstream BMP. This is referred to as X_2 .

Appendix B: Storm Water Pollutant Control Hydrologic Calculations and Sizing Methods

4. Subtract X_2 (Step 3) from X_1 (Step 2) to determine the fraction of the design volume that must be provided in the downstream BMP to achieve 80 percent capture to meet the performance standard.
5. Multiply the result of Step 4 by the DCV. This is the required downstream BMP design volume.
6. Design the BMP to retain the required volume, and confirm that the drawdown time is no more than 25 percent greater than estimated in Step 2. If the computed drawdown time is greater than 125 percent of the estimated drawdown, then return to Step 2 and revise the initial drawdown time assumption.

See the respective BMP facts sheets for BMP-specific instructions for the calculation of volume and drawdown time.

Example B.4.2.2 Percent Capture Method for Sizing BMPs in Series:

Given:
<ul style="list-style-type: none"> • Estimated drawdown time for downstream BMP: 72 Hours • DCV for the area draining to the BMP: 3000 ft³ • Upstream BMP volume: 900 ft³ • Upstream BMP drawdown time: 24 Hours
Required:
<ul style="list-style-type: none"> • Determine the volume required in the downstream BMP to achieve 80 percent capture.
Solution:
<ol style="list-style-type: none"> 1. Step 1A: Upstream BMP Capture Ratio = $900/3000 = 0.3$; Step 1B: Average annual capture efficiency achieved by upstream BMP = 44% 2. Downstream BMP drawdown = 72 hours; Fraction of DCV required to achieve 80% capture = 1.35 3. Locate intersection of design capture efficiency and drawdown time for upstream BMP (See Graph); Fraction of DCV already provided (X_2) = 0.50 (See Graph) 4. Fraction of DCV Required by downstream BMP = $1.35 - 0.50 = 0.85$ 5. DCV (given) = 3000 ft³; Required downstream BMP volume = $3000 \text{ ft}^3 \times 0.85 = 2,550 \text{ ft}^3$ 6. Design BMP and confirm drawdown Time is ≤ 90 Hours (72 Hours +25%)

Appendix B: Storm Water Pollutant Control Hydrologic Calculations and Sizing Methods

Example B.4.2.2 Continued:

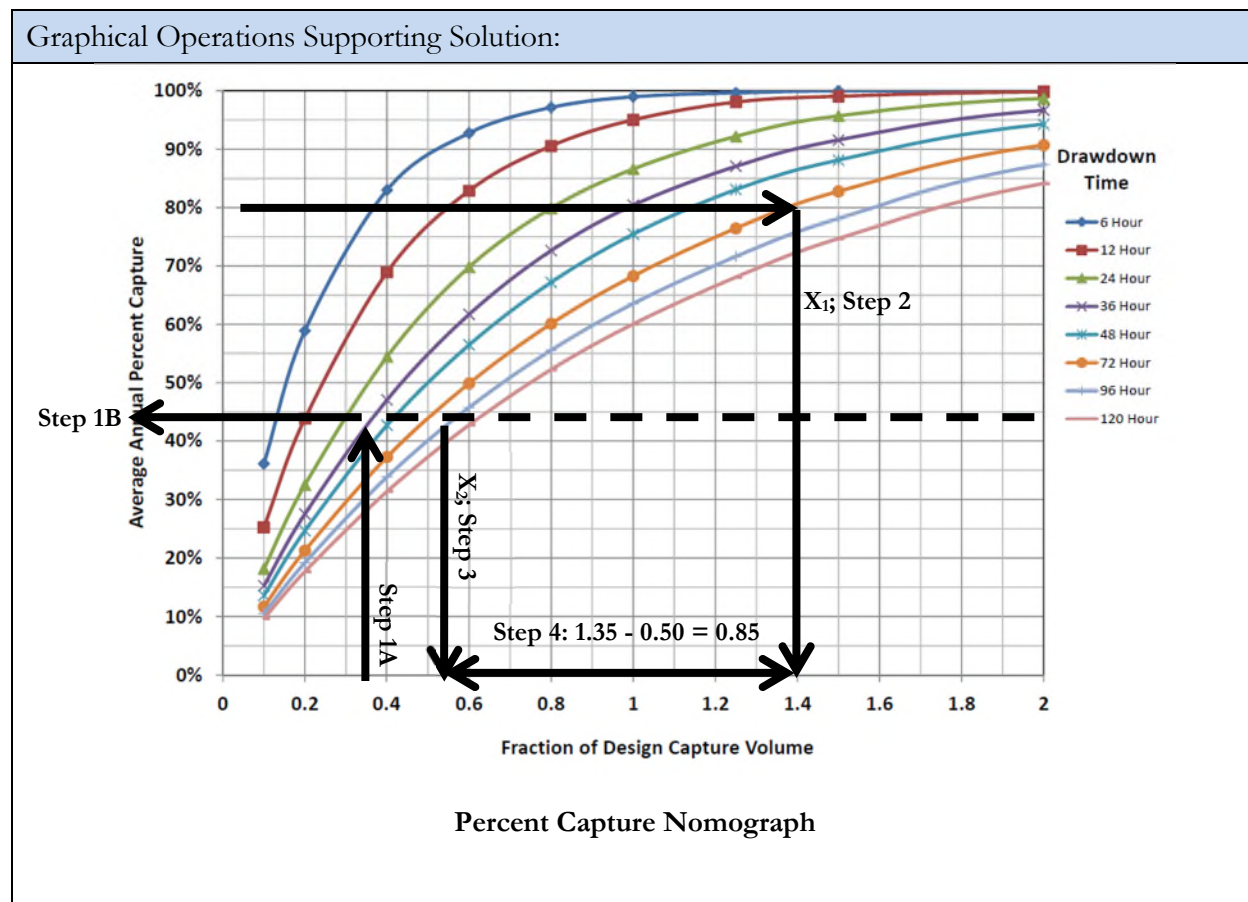

B.4.3 Technical Basis for Equivalent Sizing Methods

Storm water BMPs can be conceptualized as having a storage volume and a treatment rate, in various proportions. Both are important in the long-term performance of the BMP under a range of actual storm patterns, depths, and inter-event times. Long-term performance is measured by the operation of a BMP over the course of multiple years, and provides a more complete metric than the performance of a BMP during a single event, which does not take into account antecedent conditions, including multiple storms arriving in short timeframes. A BMP that draws down more quickly would be expected to capture a greater fraction of overall runoff (i.e., long-term runoff) than an identically sized BMP that draws down more slowly. This is because storage is made available more quickly, so subsequent storms are more likely to be captured by the BMP. In contrast a BMP with a long drawdown time would stay mostly full, after initial filling, during periods of sequential storms. The volume in the BMP that draws down more quickly is more “valuable” in terms of long term performance than the volume in the one that draws down more slowly. The MS4 permit definition of the DCV does not specify a drawdown time, therefore the definition is not a complete indicator of a

Appendix B: Storm Water Pollutant Control Hydrologic Calculations and Sizing Methods

BMP's level of performance. An accompanying performance-based expression of the BMP sizing standard is essential to ensure uniformity of performance across a broad range of BMPs and helps prevent BMP designs from being used that would not be effective.

An evaluation of the relationships between BMP design parameters and expected long term capture efficiency has been conducted to address the needs identified above. Relationships have been developed through a simplified continuous simulation analysis of precipitation, runoff, and routing, that relate BMP design volume and storage recovery rate (i.e., drawdown time) to an estimated long term level of performance using United States Environmental Protection Agency (USEPA) SWMM and parameters listed in Appendix G for Lake Wohlford, Lindbergh, and Oceanside rain gages. Comparison of the relationships developed using the three gages indicated that the differences in relative capture estimates are within the uncertainties in factors used to develop the relationships. For example, the estimated average annual capture for the BMP sized for the DCV and 36 hour drawdown using Lake Wohlford, Lindbergh, and Oceanside are 80%, 76% and 83% respectively. In an effort to reduce the number of curves that are made available, relationships developed using Lake Wohlford are included in this manual for use in the whole San Diego County region.

Figure B.4-1 demonstrated that a BMP sized for the runoff volume from the 85th percentile, 24-hour storm event (i.e., the DCV), which draws down in 36 hours is capable of managing approximately 80 percent of the average annual. There is long precedent for 80 percent capture of average annual runoff as approximately the point at which larger BMPs provide decreasing capture efficiency benefit (also known as the “knee of the curve”) for BMP sizing. The characteristic shape of the plot of capture efficiency versus storage volume in Figure B.4-1 illustrates this concept.

As such, this equivalency (between DCV draw down in 36-hours and 80 percent capture) has been utilized to provide a common currency between volume-based BMPs with a wide range of drawdown rates. This approach allows flexibility in the design of BMPs while ensuring consistent performance.

B.5 Biofiltration BMPs

Biofiltration BMPs shall be sized by one of the following sizing methods:

Option 1: Treat 1.5 times the portion of the DCV not reliably retained onsite, OR

Option 2: Treat 1.0 times the portion of the DCV not reliably retained onsite; and additionally check that the system has a total static (i.e., non-routed) storage volume, including pore spaces and pre-filter detention volume, equal to at least 0.75 times the portion of the DCV not reliably retained onsite.

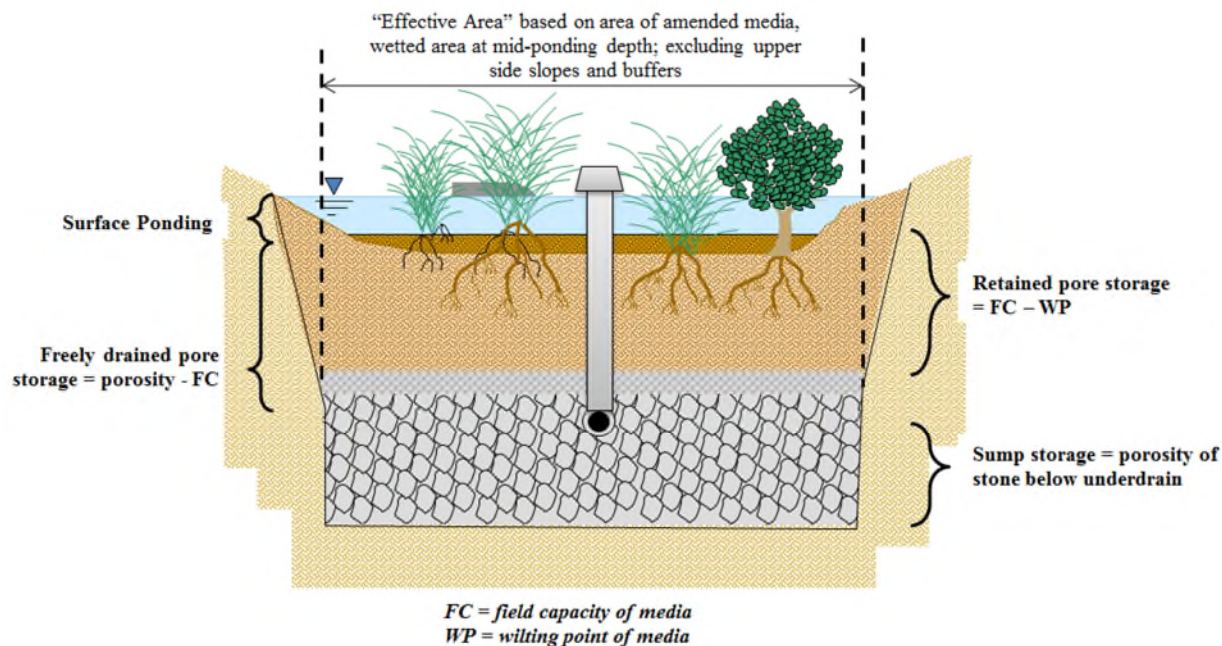

Explanation of Biofiltration Volume Compartments for Sizing Purposes

Worksheet B.5-1 provides a simple sizing method for sizing biofiltration BMP with partial retention and biofiltration BMP.

When using sizing option 1 a routing period of 6 hours is allowed. The routing period was estimated based on 50th percentile storm duration for storms similar to 85th percentile rainfall depth. It was estimated based on inspection of continuous rainfall data from Lake Wohlford, Lindbergh and Oceanside rain gages.

Appendix B: Storm Water Pollutant Control Hydrologic Calculations and Sizing Methods

Worksheet B.5-1: Simple Sizing Method for Biofiltration BMPs

Simple Sizing Method for Biofiltration BMPs		Worksheet B.5-1	
1	Remaining DCV after implementing retention BMPs		cubic-feet
Partial Retention			
2	Infiltration rate from Worksheet D.5-1 if partial infiltration is feasible		in/hr.
3	Allowable drawdown time for aggregate storage below the underdrain	36	hours
4	Depth of runoff that can be infiltrated [Line 2 x Line 3]		inches
5	Aggregate pore space	0.40	in/in
6	Required depth of gravel below the underdrain [Line 4/ Line 5]		inches
7	Assumed surface area of the biofiltration BMP		sq-ft
8	Media retained pore storage	0.1	in/in
9	Volume retained by BMP $[(\text{Line } 4 + (\text{Line } 12 \times \text{Line } 8))/12] \times \text{Line } 7$		cubic-feet
10	DCV that requires biofiltration [Line 1 – Line 9]		cubic-feet
BMP Parameters			
11	Surface Ponding [6 inch minimum, 12 inch maximum]		inches
12	Media Thickness [18 inches minimum] , also add mulch layer thickness to this line for sizing calculations		inches
13	Aggregate Storage above underdrain invert (12 inches typical) – use 0 inches for sizing if the aggregate is not over the entire bottom surface area		inches
14	Media available pore space	0.2	in/in
15	Media filtration rate to be used for sizing (5 in/hr. with no outlet control; if the filtration rate is controlled by the outlet use the outlet controlled rate)	5	in/hr.
Baseline Calculations			
16	Allowable Routing Time for sizing	6	hours
17	Depth filtered during storm [Line 15 x Line 16]	30	inches
18	Depth of Detention Storage [Line 11 + (Line 12 x Line 14) + (Line 13 x Line 5)]		inches
19	Total Depth Treated [Line 17 + Line 18]		inches
Option 1 – Biofilter 1.5 times the DCV			
20	Required biofiltered volume [1.5 x Line 10]		cubic-feet
21	Required Footprint [Line 20/ Line 19] x 12		sq-ft
Option 2 - Store 0.75 of remaining DCV in pores and ponding			
22	Required Storage (surface + pores) Volume [0.75 x Line 10]		cubic-feet
23	Required Footprint [Line 22/ Line 18] x 12		sq-ft
Footprint of the BMP			
24	Area draining to the BMP		sq-ft
25	Adjusted Runoff Factor for drainage area (Refer to Appendix B.1 and B.2)		
26	Minimum BMP Footprint [Line 24 x Line 25 x 0.03]		sq-ft
25	Footprint of the BMP = Maximum(Minimum(Line 21, Line 23), Line 26)		sq-ft

Appendix B: Storm Water Pollutant Control Hydrologic Calculations and Sizing Methods

Simple Sizing Method for Biofiltration BMPs		Worksheet B.5-1	
26	BMP Footprint Sizing Factor (Default 0.03 or an alternative minimum footprint sizing factor from Worksheet B.5-2, Line 11)		unitless
27	Minimum BMP Footprint [Line 24 x Line 25 x Line 26]		sq-ft
28	Footprint of the BMP = Maximum(Minimum(Line 21, Line 23), Line 27)		sq-ft
Check for Volume Reduction [Not applicable for No Infiltration Condition]			
29	Calculate the fraction of the DCV retained by the BMP [Line 9/ Line 1]		unitless
30	Minimum required fraction of DCV retained for partial infiltration condition	0.375	unitless
31	Is the retained DCV > 0.375? If the answer is no increase the footprint sizing factor in Line 26 until the answer is yes for this criterion.	<input type="checkbox"/> Yes <input type="checkbox"/> No	

Note:

1. Line 7 is used to estimate the amount of volume retained by the BMP. Update assumed surface area in Line 7 until its equivalent to the required biofiltration footprint (either Line 21 or Line 23)
2. The DCV fraction of 0.375 is based on a 40% average annual percent capture and a 36-hour drawdown time.
3. The increase in footprint for volume reduction can be optimized using the approach presented in Appendix B.5.2. The optimized footprint cannot be smaller than the alternative minimum footprint sizing factor from Worksheet B.5-2.
4. If the proposed biofiltration BMP footprint is smaller than the alternative minimum footprint sizing factor from Worksheet B.5-2, but satisfies Option 1 or Option 2 sizing, it is considered a compact biofiltration BMP and may be allowed at the discretion of the [City Engineer], if it meets the requirements in Appendix F.

B.5.1 Basis for Minimum Sizing Factor for Biofiltration BMPs

B.5.1.1 Introduction

MS4 Permit Provision E.3.c.(1)(a)(i)

The MS4 Permit describes conceptual performance goals for biofiltration BMPs and specifies numeric criteria for sizing biofiltration BMPs (See Section 2.2.1 of this Manual).

However, the MS4 Permit does not define a specific footprint sizing factor or design profile that must be provided for the BMP to be considered “biofiltration.” Rather, the MS4 Permit specifies (Footnote 25):

As part of the Copermittee’s update to its BMP Design Manual, pursuant to Provision E.3.d, the Copermittee must provide guidance for hydraulic loading rates and other biofiltration design criteria necessary to maximize storm water retention and pollutant removal.

To meet this provision, this manual includes specific criteria for design of biofiltration BMPs. Among other criteria, a minimum footprint sizing factor of 3 percent (BMP footprint area as percent of contributing area times adjusted runoff factor) is specified. The purpose of this section is to provide the technical rationale for this 3 percent minimum sizing factor.

B.5.1.2 Conceptual Need for Minimum Sizing Factor

Under the 2011 Model SUSMP, a sizing factor of 4 percent was used for sizing biofiltration BMPs. This value was derived based on the goal of treating the runoff from a 0.2 inch per hour uniform precipitation intensity at a constant media flow rate of 5 inches per hour. While this method was simple, it was considered to be conservative as it did not account for significant transient storage present in biofiltration BMPs (i.e., volume in surface storage and subsurface storage that would need to fill before overflow occurred). Under this manual, biofiltration BMPs will typically provide subsurface storage to promote infiltration losses; therefore typical BMP profiles will tend to be somewhat deeper than those provided under the 2011 Model SUSMP. A deeper profile will tend to provide more transient storage and allow smaller footprint sizing factors while still providing similar or better treatment capacity and pollutant removal. Therefore a reduction in the minimum sizing factor from the factor used in the 2011 Model SUSMP is supportable. However, as footprint decreases, issues related to potential performance, operations, and/or maintenance can increase for a number of reasons:

- 1) As the surface area of the media bed decreases, the sediment loading per unit area increases, increasing the risk of clogging. While vigorous plant growth can help maintain permeability

Appendix B: Storm Water Pollutant Control Hydrologic Calculations and Sizing Methods

of soil, there is a conceptual limit above which plants may not be able to mitigate for the sediment loading. Scientific knowledge is not conclusive in this area.

- 2) With smaller surface areas and greater potential for clogging, water may be more likely to bypass the system via overflow before filling up the profile of the BMP.
- 3) As the footprint of the system decreases, the amount of water that can be infiltrated from subsurface storage layers and evapotranspire from plants and soils tends to decrease.
- 4) With smaller sizing factors, the hydraulic loading per unit area increases, potentially reducing the average contact time of water in the soil media and diminishing treatment performance.

The MS4 Permit requires that volume and pollutant retention be maximized. Therefore, a minimum sizing factor was determined to be needed. This minimum sizing factor does not replace the need to conduct sizing calculations as described in this manual; rather it establishes a lower limit on required size of biofiltration BMPs as the last step in these calculations. Additionally, it does not apply to alternative biofiltration designs that utilize the checklist in Appendix F (Biofiltration Standard and Checklist). Acceptable alternative designs (such as proprietary systems meeting Appendix F criteria) typically include design features intended to allow acceptable performance with a smaller footprint and have undergone field scale testing to evaluate performance and required O&M frequency.

B.5.1.3 Lines of Evidence to Select Minimum Sizing Factor

Three primary lines of evidence were used to select the minimum sizing factor of 3 percent (BMP footprint area as percent of contributing area times adjusted runoff factor) in this manual:

1. Typical design calculations.
2. Volume reduction performance.
3. Sediment clogging calculations.

These lines of evidence and associated findings are explained below.

Typical Design Calculations

A range of BMP profiles were evaluated for different design rainfall depths and soil conditions. Worksheet B.5-1 was used for each case to compute the required footprint sizing factor. For these calculations, the amount of water filtered during the storm event was determined based on a media filtration rate of 5 inches per hour and a routing time of 6 hours. These input assumptions are considered to be well-supported and consistent with the intent of the MS4 Permit. These calculations generally yielded footprint factors between 1.5 and 4.9 percent. In the interest of establishing a uniform County-wide minimum sizing factor, a 3 percent sizing factor was selected from this range, consistent with other lines of evidence.

Volume Reduction Performance

Consistent with guidance in Fact Sheet PR-1, the amount of retention storage (in gravel sump below

Appendix B: Storm Water Pollutant Control Hydrologic Calculations and Sizing Methods

underdrain) that would drain in 36 hours was calculated for a range of soil types. This was used to estimate the volume reduction that would be expected to be achieved. For a sizing factor of 3 percent and a soil filtration rate of 0.20 inches per hour, the average annual volume reduction was estimated to be approximately 40 percent (via percent capture method; see Appendix B.4.2).

In describing the basis for equivalency between retention and biofiltration (1.5 multiplier), the MS4 Permit Fact Sheet referred to analysis prepared in the Ventura County Technical Guidance Manual. The Ventura County analysis considered the pollutant treatment as well as the volume reduction provided by biofiltration in considering equivalency to retention. This analysis assumed an average long term volume reduction of 40 percent based on analysis of data from the International Stormwater BMP Database. The calculations of estimated volume reduction at a 3 percent sizing factor is (previous paragraph) consistent with this value. While estimated volume reduction is sensitive to site-specific factors, this analysis suggests that a sizing factor of approximately 3 percent provides levels of volume reduction that are reasonably consistent with the intent of the MS4 Permit.

Sediment Clogging Calculations

As sediment accumulates in a filter, the permeability of the filter tends to decline. The lifespan of the filter bed can be estimated by determining the rate of sediment loading per unit area of the filter bed. To determine the media bed surface area sizing factor needed to provide a target lifespan, simple sediment loading calculations were conducted based on typical urban conditions. The inputs and results of this calculation are summarized in Table B.5-3.

B.5-3: Inputs and Results of Clogging Calculation

Parameter	Value	Source
Representative TSS Event Mean Concentration, mg/L	100	Approximate average of San Diego Land Use Event Mean Concentrations from San Diego River and San Luis Rey River WQIP
Runoff Coefficient of Impervious Surface	0.90	Table B.1-1
Runoff Coefficient of Pervious Surface	0.10	Table B.1-1 for landscape areas
Imperviousness	40% to 90%	Planning level assumption, covers typical range of single family to commercial land uses
Average Annual Precipitation, inches	11 to 13	Typical range for much of urbanized San Diego County
Load to Initial Maintenance, kg/m ²	10	Pitt, R. and S. Clark, 2010. Evaluation of Biofiltration Media for Engineered Natural Treatment Systems.
Allowable period to initial clogging, yr.	10	Planning-level assumption
Estimated BMP Footprint Needed for 10-Year Design Life	2.8 to 3.3%	Calculated

This analysis suggests that a 3 percent sizing factor, coupled with sediment source controls and careful

Appendix B: Storm Water Pollutant Control Hydrologic Calculations and Sizing Methods

system design, should provide reasonable protection against premature clogging. However, there is substantial uncertainty in sediment loading and the actual load to clog that will be observed under field conditions in the San Diego climate. Additionally this analysis did not account for the effect of plants on maintaining soil permeability. Therefore this line of evidence should be considered provisional, subject to refinement based on field scale experience. As field scale experience is gained about the lifespan of biofiltration BMPs in San Diego and the mitigating effects of plants on long term clogging, it may be possible to justify lower factors of safety and therefore smaller design sizes in some cases. If a longer lifespan is desired and/or greater sediment load is expected, then a larger sizing factor may be justified.

B.5.1.4 Discussion

Generally, the purpose of a minimum sizing factor is to help improve the performance and reliability of standard biofiltration systems and limit the use of sizing methods and assumptions that may lead to designs that are less consistent with the intent of the MS4 Permit.

Ultimately, this factor is a surrogate for a variety of design considerations, including clogging and associated hydraulic capacity, volume reduction potential, and treatment contact time. A prudent design approach should consider each of these factors on a project-specific basis and identify whether site conditions warrant a larger or smaller factor. For example a system treating only rooftop runoff in an area without any allowable infiltration may have negligible clogging risk and negligible volume reduction potential – a smaller sizing factor may not substantially reduce performance in either of these areas. Alternatively, for a site with high sediment load and limited pre-treatment potential, a larger sizing factor may be warranted to help mitigate potential clogging risks. City Engineer has discretion to accept alternative sizing factor(s) based on project-specific or jurisdiction-specific considerations. Additionally, the recommended minimum sizing factor may change over time as more experience with biofiltration is obtained.

The worksheet B.5-2 below shall be used to support a request for an alternative minimum footprint sizing factor. Based on a review of the submitted worksheet and supporting documentation, the use of a smaller footprint sizing factor may be approved at the discretion of the [City Engineer]. If approved, the estimated footprint from the worksheet below can be used in line 26 of worksheet B.5-1 in lieu of the 3 percent minimum footprint value.

This worksheet includes the following general steps to calculate the minimum footprint sizing factor:

- Select a “load to clog” that is representative of the type of BMP proposed
- Select a target life span (i.e., frequency of major maintenance) that is acceptable to the [City Engineer]. A default value of 10 years is recommended.
- Compile information about the DMA from other parts of the SWQMP development process.

Appendix B: Storm Water Pollutant Control Hydrologic Calculations and Sizing Methods

- Determine the event mean concentration (EMC) of TSS that is appropriate for the DMA
- Perform calculations to determine the minimum footprint to provide the target lifespan.

Appendix B: Storm Water Pollutant Control Hydrologic Calculations and Sizing Methods

Worksheet B.5-2: Calculation of Alternative Minimum Footprint Sizing Factor

Alternative Minimum Footprint Sizing Factor			Worksheet B.5-2 (Page 1 of 2)
1	Area draining to the BMP		sq-ft
2	Adjusted Runoff Factor for drainage area (Refer to Appendix B.1 and B.2)		
3	Load to Clog ¹ (See Table B.5-2 for guidance; L _c)	2.0	lb/sq-ft
4	Allowable Period to Accumulate Clogging Load (T _i)	10	years
Volume Weighted EMC Calculation			
	Land Use	Fraction of Total DCV	TSS EMC (mg/L)
	Single Family Residential		123
	Commercial		128
	Industrial		125
	Education (Municipal)		132
	Transportation		78
	Multi-family Residential		40
	Roof Runoff		14
	Low Traffic Areas		50
	Open Space		216
	Other, specify:		
	Other, specify:		
	Other, specify:		
5	Volume Weighted EMC (sum of all products)		mg/L
BMP Parameters			
6	If pretreatment measures are included in the design, apply an adjustment of 25% ² [Line 5 x (1-0.25)]		mg/L
7	Average Annual Precipitation		inches
8	Calculate the Average Annual Runoff (Line 7 x 43,560/12) x Line 2		cu-ft/yr
9	Calculate the Average Annual TSS Load (Line 8 x 62.4 x Line 6)/10 ⁶		lb/yr
10	Calculate the BMP Footprint Needed (Line 9 x Line 4)/Line 3		sq-ft
11	Calculate the Alternative Minimum Footprint Sizing Factor [Line 10/ (Line 1 x Line 2)]		

¹ Load to clog value should be in the range of 2 – 5 lb/sq-ft per Pitt and Clark (2010). If selecting a value other than 2, a justification for the value selected is required. See guidance in Table B.5-2.

² A value of 25 percent is supported by Maniquiz-Redillas et al. (2014) study, which found a pretreatment sediment capture range of 15% - 35%. If using a value outside of this range, documentation of the selected value is required. A value of 50 percent can be claimed for a system with an active Washington State TAPE approval rating for “pre-treatment.”

Appendix B: Storm Water Pollutant Control Hydrologic Calculations and Sizing Methods

Table B.5-1: Typical land use total suspended solids (TSS) event mean concentration (EMC) values.

Land Use	TSS EMC ³ , mg/L
Single Family Residential	123
Commercial	128
Industrial	125
Education (Municipal)	132
Transportation ⁴	78
Multi-family Residential	40
Roof Runoff ⁵	14
Low Traffic Areas ⁶	50
Open Space	216

Table B.5-2: Guidance for Selecting Load to Clog (LC)

BMP Configuration	Load to Clog, L _c , lb/sq-ft
Baseline: Approximately 50 percent vegetative cover; typical fine sand and compost blend	2
Baseline + increase vegetative cover to at least 75 percent	3
Baseline + include coarser sand to increase initial permeability to 20 to 30 in/hr; control flowrate with outlet control	3
Baseline + increase vegetative cover and include more permeable media with outlet control, per above	4

References

- Charters, F.J., Cochrane, T.A., and O’Sullivan, A.D., (2015). Particle Size Distribution Variance in Untreated Urban Runoff and its implication on treatment selection. *Water Research*, 85 (2015), pg. 337-345.
- Davis, A.P. and McCuen, R.H., (2005). *Stormwater Management for Smart Growth*. Springer Science & Business Media, pg. 155.
- Maniquiz-Redillas, M.C., Geronimo, F.K.F, and Kim, L-H. Investigation on the Effectiveness of Pretreatment in Stormwater Management Technologies. *Journal of Environmental Sciences*, 26 (2014), pg. 1824-1830.
- Pitt, R. and Clark, S.E., (2010). *Evaluation of Biofiltration Media for Engineered Natural Treatment Systems*. Geosyntec Consultants and The Boeing Company.

³ EMCs are from SBPAT datasets for SLR and SDR Watersheds – Arithmetic Estimates of the Lognormal Summary Statistics for San Diego, unless otherwise noted.

⁴ EMCs are based on Los Angeles region default SBPAT datasets due to lack of available San Diego data.

⁵ Value represents the average first flush concentration for roof runoff (Charters et al., 2015).

⁶ Davis and McCuen (2005)

B.5.2 Sizing Biofiltration BMPs Downstream of a Storage Unit

B.5.2.1 Introduction

In scenarios, where the BMP footprint is governed based on Option 1 (Line 21 of Worksheet B.5-1) or the required volume reduction of 40% average annual (long term) runoff capture for partial infiltration conditions (Line 31 of Worksheet B.5.1) the footprint of the biofiltration BMP can be optimized using the sizing calculations in this Appendix B.5.2 when there is an upstream storage unit (e.g. cistern) that can be used to regulate the flows through the biofiltration BMP.

This methodology is **not** applicable when the minimum footprint factor is governed based on the alternative minimum footprint sizing factor calculated using Worksheet B.5-2 (Line 11). Biofiltration BMP smaller than the alternative minimum footprint sizing factor is considered compact biofiltration BMP and may be allowed at the discretion of the [City Engineer] if the BMP meets the requirements in Appendix F **and** Option 1 or Option 2 sizing in Worksheet B.5-1.

B.5.2.2 Sizing Calculations

Sizing calculations for the biofiltration footprint shall demonstrate that one of two equivalent performance standards is met:

1. Use continuous simulation and demonstrate one of the following is met based on the infiltration condition identified in Chapter 5.4.2:
 - a. **No infiltration condition:** The BMP or series of BMPs biofilters at least 92 percent of average annual (long term) runoff volume. This can be demonstrated through reporting of output from the San Diego Hydrology Model, or through other continuous simulation modeling meeting the criteria in Appendix G, as acceptable to the [City Engineer]. The 92 percent of average annual runoff treatment corresponds to the average capture achieved by implementing a BMP with 1.5 times the DCV and a drawdown time of 36 hours (Appendix B.4.2).
 - b. **Partial infiltration condition:** The BMP or series of BMPs biofilters at least 92 percent of average annual (long term) runoff volume and achieves a volume reduction of at least 40 percent of average annual (long term) runoff volume. This can be demonstrated through reporting of output from the San Diego Hydrology Model, or through other continuous simulation modeling meeting the criteria in Appendix G, as acceptable to the [City Engineer].
2. Use the simple sizing method in Worksheet B.5-3. The applicant is also required to complete Worksheet B.5-1 and B.5-2 when the applicant elects to use Worksheet B.5-3 to optimize the biofiltration BMP footprint. Worksheet B.5-3 was developed to satisfy the following two criteria as applicable:
 - a. Greater than 92 percent of the average annual runoff volume from the storage unit is routed to the biofiltration BMP through the low flow orifice and the peak flow from the low flow orifice can instantaneously be filtered through the biofiltration media. If the outlet design includes orifices at different elevations and an overflow structure,

Appendix B: Storm Water Pollutant Control Hydrologic Calculations and Sizing Methods

only flows from the overflow structure should be excluded from the calculation (both for 92 percent capture and for peak flow to the biofiltration BMP that needs to be instantaneously filtered), unless the flows from other orifices also bypass the biofiltration BMP, in which case flows from the orifices that bypass should also be excluded.

- b. The retention losses from the optimized biofiltration BMP is equal to or greater than the retention losses from the conventional biofiltration BMP. This second criterion is only applicable for partial infiltration condition.

Table B.5-3 Storage required for different drawdown times

Drawdown Time (hours)	Storage requirement (below the overflow elevation, or below outlet elevation that bypass the biofiltration BMP)
12	0.85 DCV
24	1.25 DCV
36	1.50 DCV
48	1.80 DCV
72	2.20 DCV
96	2.60 DCV
120	2.80 DCV

For drawdown times that are outside the range of values presented in Table B.5-4 above the storage unit should be designed to discharge greater than 92% average annual capture to the downstream Biofiltration BMP.

Appendix B: Storm Water Pollutant Control Hydrologic Calculations and Sizing Methods

Worksheet B.5-3: Optimized Biofiltration BMP Footprint when Downstream of a Storage Unit

Optimized Biofiltration BMP Footprint when Downstream of a Storage Unit		Worksheet B.5-3	
1	Area draining to the storage unit and biofiltration BMP		sq-ft
2	Adjusted runoff factor for drainage area (Refer to Appendix B.1 and B.2)		
3	Effective impervious area draining to the storage unit and biofiltration BMP [Line 1 x Line 2]		sq-ft
4	Remaining DCV after implementing retention BMPs		cubic-feet
5	Infiltration rate from Worksheet D.5-1 if partial infiltration is feasible		ft/hr.
6	Media Thickness [1.5 feet minimum], also add mulch layer thickness to this line for sizing calculations		ft
7	Media filtration rate to be used for sizing (0.42 ft/hr. with no outlet control; if the filtration rate is controlled by the outlet use the outlet controlled rate)		ft/hr
8	Media retained pore storage	0.1	ft/ft
Storage Unit Requirement			
9	Drawdown time of the storage unit, minimum(from the elevation that bypasses the biofiltration BMP, overflow elevation)		hours
10	Storage required to achieve greater than 92 percent capture (see Table B.5- 4)		fraction
11	Storage required in cubic feet (Line 4 x Line 10)		cubic-feet
12	Storage provided in the design, minimum(from the elevation that bypasses the biofiltration BMP, overflow elevation)		cubic-feet
13	Is Line 12 \geq Line 11. If no increase storage provided until this criteria is met	<input type="checkbox"/> Yes <input type="checkbox"/> No	
Criteria 1: BMP Footprint Biofiltration Capacity			
14	Peak flow from the storage unit to the biofiltration BMP (using the elevation used to evaluate the percent capture)		cfs
15	Required biofiltration footprint [(3,600 x Line 14)/Line 7]		sq-ft
Criteria 2: Alternative Minimum Sizing Factor (Clogging)			
16	Alternative Minimum Footprint Sizing Factor [Line 11 of Worksheet B.5- 2]		Fraction
17	Required biofiltration footprint [Line 3 x Line 16]		sq-ft
Criteria 3: Retention requirement [Not applicable for No Infiltration Condition]			
18	Conventional biofiltration footprint Line 28 of Worksheet B.5-1		sq-ft
19	Retention Losses from the conventional footprint (36 x Line 5 + Line 6 x Line 8) x Line 18		cubic-feet
20	Average discharge rate from the storage unit to the biofiltration BMP		cfs
21	Depth retained in the optimized biofiltration BMP {Line 6 x Line 8} + {(Line 4)/(2400 x Line 20)} x Line 5		ft
22	Required optimized biofiltration footprint (Line 19/Line 21)		sq-ft
Optimized Biofiltration Footprint			
23	Optimized biofiltration footprint, maximum(Line 15, Line 17, Line 22)		sq-ft

Note: Biofiltration BMP smaller than the alternative minimum footprint sizing (Line 17) is considered compact biofiltration BMP and may be allowed at the discretion of the [City Engineer] if the BMP meets the requirements in Appendix F and Option 1 or Option 2 sizing in Worksheet B.5-1.

B.6 Flow-Through Treatment Control BMPs (for use with Alternative Compliance)

The following methodology shall be used for selecting and sizing onsite flow-through treatment control BMPs for use as pre-treatment.

Note that the City of Vista does not have an alternative compliance program, so flow through treatment control BMPs should only be used for pre-treatment as of the implementation date of this Manual.

This methodology consists of three steps:

- 1) Determine the PDP most significant pollutants of concern (Appendix B.6.1).
- 2) Select a flow-through treatment control BMP that treats the PDP most significant pollutants of concern and meets the pollutant control BMP treatment performance standard (Appendix B.6.2).
- 3) Size the selected flow-through treatment control BMP (Appendix B.6.3).

B.6.1 PDP Most Significant Pollutants of Concern

The following steps shall be followed to identify the PDP most significant pollutants of concern:

- 1) Compile the following information for the PDP and receiving water:
 - a. Receiving water quality (including pollutants for which receiving waters are listed as impaired under the Clean Water Act section 303(d) List; refer to Section 1.9);
 - b. Pollutants, stressors, and/or receiving water conditions that cause or contribute to the highest priority water quality conditions identified in the WQIP (refer to Section 1.9);
 - c. Land use type(s) proposed by the PDP and the storm water pollutants associated with the PDP land use(s) (see Table B.6–1).
- 2) From the list of pollutants identified in Step 1 identify the most significant PDP pollutants of concern. A PDP could have multiple most significant pollutants of concerns and shall include the highest priority water quality condition identified in the watershed WQIP and pollutants anticipated to be present onsite/generated from land use.

Appendix B: Storm Water Pollutant Control Hydrologic Calculations and Sizing Methods

TABLE B.6-1: Anticipated and Potential Pollutants Generated by Land Use Type

Priority Project Categories	General Pollutant Categories								
	Sediment	Nutrients	Heavy Metals	Organic Compounds	Trash & Debris	Oxygen Demanding Substances	Oil & Grease	Bacteria & Viruses	Pesticides
Detached Residential Development	X	X			X	X	X	X	X
Attached Residential Development	X	X			X	P(1)	P(2)	P	X
Commercial Development >one acre	P(1)	P(1)	X	P(2)	X	P(5)	X	P(3)	P(5)
Heavy Industry	X		X	X	X	X	X		
Automotive Repair Shops			X	X(4)(5)	X		X		
Restaurants					X	X	X	X	P(1)
Hillside Development >5,000 ft ²	X	X			X	X	X		X
Parking Lots	P(1)	P(1)	X		X	P(1)	X		P(1)
Retail Gasoline Outlets			X	X	X	X	X		
Streets, Highways & Freeways	X	P(1)	X	X(4)	X	P(5)	X	X	P(1)

X = anticipated
P = potential
(1) A potential pollutant if landscaping exists onsite.
(2) A potential pollutant if the project includes uncovered parking areas.
(3) A potential pollutant if land use involves food or animal waste products.
(4) Including petroleum hydrocarbons.
(5) Including solvents.

Appendix B: Storm Water Pollutant Control Hydrologic Calculations and Sizing Methods

B.6.2 Selection of Flow-Through Treatment Control BMPs

The following steps shall be followed to select the appropriate flow-through treatment control BMPs for the PDP:

- 1) For each PDP most significant pollutant of concern identify the grouping using Table B.6-2. Table B.6-2 is adopted from the Model SUSMP.
- 2) Select the flow-through treatment control BMP based on the grouping of pollutants of concern that are identified to be most significant in Step 1. This section establishes the pollutant control BMP treatment performance standard to be met for each grouping of pollutants in order to meet the standards required by the MS4 permit and how an applicant can select a non-proprietary or a proprietary BMP that meets the established performance standard. The grouping of pollutants of concern are:
 - a. Coarse Sediment and Trash (Appendix B.6.2.1)
 - b. Pollutants that tend to associate with fine particles during treatment (Appendix B.6.2.2)
 - c. Pollutants that tend to be dissolved following treatment (Appendix B.6.2.3)

TABLE B.6-2: Grouping of Potential Pollutants of Concern

Pollutant	Coarse Sediment and Trash	Suspended Sediment and Particulate-bound Pollutants ¹	Soluble-form Dominated Pollutants ²
Sediment	X	X	
Nutrients			X
Heavy Metals		X	
Organic Compounds		X	
Trash & Debris	X		
Oxygen Demanding		X	
Bacteria		X	
Oil & Grease		X	
Pesticides		X	

¹ Pollutants in this category can be addressed to Medium or High effectiveness by effectively removing suspended sediments and associated particulate-bound pollutants. Some soluble forms of these pollutants will exist, however treatment mechanisms to address soluble pollutants are not necessary to remove these pollutants to a Medium or High effectiveness.

² Pollutants in this category are not typically addressed to a Medium or High level of effectiveness with particle and particulate-bound pollutant removal alone.

One flow-through BMP can be used to satisfy the required pollutant control BMP treatment performance standard for the PDP most significant pollutants of concern. In some situations it might

Appendix B: Storm Water Pollutant Control Hydrologic Calculations and Sizing Methods

be necessary to implement multiple flow-through BMPs to satisfy the pollutant control BMP treatment performance standards. For example, a PDP has trash, nutrients and bacteria as the most significant pollutants of concern. If a vegetated filter strip is selected as a flow-through BMP then it is anticipated to meet the performance standard in Appendix B.6.2.2 and B.6.2.3 but would need a trash removal BMP to meet the pollutant control BMP treatment performance standard in Appendix B.6.2.1 upstream of the vegetated filter strip. This could be achieved by fitting the inlets and/or outlets with racks or screens on to address trash.

B.6.2.1 Coarse Sediment and Trash

If coarse sediment and/or trash and debris are identified as a pollutant of concern for the PDP, then BMPs must be selected to capture and remove these pollutants from runoff. The BMPs described below can be effective in removing coarse sediment and/or trash. These devices must be sized to treat the flow rate estimated using Worksheet B.6-1. Applicant can only select BMPs that have High or Medium effectiveness.

Trash Racks and Screens [Coarse Sediment: Low effectiveness; Trash: Medium to High effectiveness] are simple devices that can prevent large debris and trash from entering storm drain infrastructure and/or ensure that trash and debris are retained with downstream BMPs. Trash racks and screens can be installed at inlets to the storm drain system, at the inflow line to a BMP, and/or on the outflow structure from the BMP. Trash racks and screens are commercially available in many sizes and configurations or can be designed and fabricated to meet specific project needs.

Hydrodynamic Separation Devices [Coarse Sediment: Medium to High effectiveness; Trash: Medium to High effectiveness] are devices that remove coarse sediment, trash, and other debris from incoming flows through a combination of screening, settlement, and centrifugal forces. The design of hydrodynamic devices varies widely, more specific information can be found by contacting individual vendors. A list of hydrodynamic separator products approved by the Washington State Technology Acceptance Protocol-Ecology protocol can be found at:

<http://www.ecy.wa.gov/programs/wq/stormwater/newtech/technologies.html>.

Systems should be rated for “pretreatment” with a General Use Level Designation or provide results of field-scale testing indicating an equivalent level of performance.

Catch Basin Insert Baskets [Coarse Sediment: Low effectiveness; Trash: Medium effectiveness, if appropriately maintained] are manufactured filters, fabrics, or screens that are placed in inlets to remove trash and debris. The shape and configuration of catch basin inserts varies based on inlet type and configuration. Inserts are prone to clogging and bypass if large trash items are accumulated, and therefore require frequent observation and maintenance to remain effective. Systems with screen size small enough to retain coarse sediment will tend to clog rapidly and should be avoided.

Appendix B: Storm Water Pollutant Control Hydrologic Calculations and Sizing Methods

Other Manufactured Particle Filtration Devices [Coarse Sediment: Medium to High effectiveness; Trash: Medium to High effectiveness] include a range of products such as cartridge filters, bag filters, and other configurations that address medium to coarse particles. Systems should be rated for “pretreatment” with a General Use Level Designation under the Technology Acceptance Protocol-Ecology program or provide results of field-scale testing indicating an equivalent level of performance.

Note, any BMP that achieves Medium or High performance for suspended solids (See Section B.6.2.2) is also considered to address coarse sediments. However, some BMPs that address suspended solids do not retain trash (for example, swales and detention basins). These types of BMPs could be fitted with racks or screens on inlets or outlets to address trash.

BMP Selection for Pretreatment:

Devices that address both coarse sediment and trash can be used as pretreatment devices for other BMPs, such as infiltration BMPs. However, it is recommended that BMPs that meet the performance standard in Appendix B.6.2.2 be used. A device with a “pretreatment” rating and General Use Level Designation under Technology Acceptance Protocol-Ecology is required for pretreatment upstream of infiltration basins and underground galleries. Pretreatment may also be provided as presettling basins or forebays as part of a pollutant control BMP instead of implementing a specific pretreatment device for systems where maintenance access to the facility surface is possible (to address clogging), expected sediment load is not high, and appropriate factors of safety are included in design.

B.6.2.2 Suspended Sediment and Particulate-Bound Pollutants

Performance Standard

The pollutant treatment performance standard is shown in Table B.6-3. This performance standard is consistent with the Washington State Technology Acceptance Protocol-Ecology Basic Treatment Level, and is also met by technologies receiving Phosphorus Treatment or Enhanced Treatment certification. This standard is based on pollutant removal performance for total suspended solids. Systems that provide effective TSS treatment also typically address trash, debris, and particulate bound pollutants and can serve as pre-treatment for offsite mitigation projects or for onsite infiltration BMPs.

Table B.6-3: Performance Standard for Flow-Through Treatment Control

Influent Range	Criteria
20 – 100 mg/L TSS	Effluent goal ≤ 20 mg/L TSS
100 – 200 mg/L TSS	≥ 80% TSS removal
>200 mg/L TSS	> 80% TSS removal

Selecting Non-Proprietary BMPs

Table B.6-4 identifies the categories of non-proprietary BMPs that are considered to meet the pollutant treatment performance standard if designed to contemporary design standards⁷. BMP types with a “High” ranking should be considered before those with a “Medium” ranking. Statistical analysis by category from the International Stormwater BMP Database (also presented in Table B.6-4) indicates each of these BMP types (as a categorical group) meets or nearly meets the performance standard. The International Stormwater BMP Database includes historic as well as contemporary BMP studies; contemporary BMP designs in these categories are anticipated to meet or exceed this standard on average.

⁷ Contemporary design standards refers to design standards that are reasonably consistent with the current state of practice and are based on desired outcomes that are reasonably consistent with the context of the MS4 Permit and this manual. For example, a detention basin that is designed solely to mitigate peak flow rates would not be considered a contemporary water quality BMP design because it is not consistent with the goal of water quality improvement. Current state of the practice recognizes that a drawdown time of 24 to 72 hours is typically needed to promote settling. For practical purposes, design standards can be considered “contemporary” if they have been published within the last 10 years, preferably in California or Washington State, and are specifically intended for storm water quality management.

Appendix B: Storm Water Pollutant Control Hydrologic Calculations and Sizing Methods

Table B.6-4: Flow-Through Treatment Control BMPs Meeting Performance Standard

List of Acceptable Flow-Through Treatment Control BMPs	Statistical Analysis of International Stormwater BMP Database				Evaluation of Conformance to Performance Standard		
	Count In/Out	TSS Mean Influent, mg/L	TSS Mean Effluent ¹ , mg/L	Average Category Volume Reduct.	Volume-Adjusted Effluent Conc ² , mg/L	Volume-Adjusted Removal Efficiency ²	Level of Attainment of Performance Standard (with rationale)
Vegetated Filter Strip	361/282	69	31	38%	19	72%	Medium, effluent < 20 mg/L after volume adjustment
Vegetated Swale	399/346	45	33	48%	17	61%	Medium, effluent < 20 mg/L after volume adjustment
Detention Basin	321/346	125	42	33%	28	77%	Medium, percent removal near 80% after volume adjustment
Sand Filter/Media Bed Filter	381/358	95	19	NA ³	19	80%	High, effluent and % removal meet criteria without adjustment
Lined Porous Pavement ⁴	356/220	229	46	NA ^{3,4}	46	80%	High, % removal meets criteria without adjustment
Wet Pond	923/933	119	31	NA ³	31	74%	Medium, percent removal near 80%

Source: 2014 BMP Performance Summaries and Statistical Appendices; 2010 Volume Performance Summary; available at: www.bmpdatabase.org

1 - A statistically significant difference between influent and effluent was detected at a p value of 0.05 for all categories.

2 - Estimates were adjusted to account for category-average volume reduction.

3 - Not Applicable as these BMPs are not designed for volume reduction and are anticipated to have very small incidental volume reduction.

4 - The category presented in this table represents a lined system for flow-through treatment purposes. Porous pavement for retention purposes is an infiltration BMP, not a flow-through BMP. This table should not be consulted for porous pavement for infiltration.

Selecting Proprietary BMPs

Proprietary BMPs can be used if the BMP meets each of the following conditions:

- (1) The proposed BMP meets the performance standard in Appendix B.6.2.2 as certified through third-party, field scale evaluation.** An active General Use Level Designation for Basic Treatment, Phosphorus Treatment or Enhanced Treatment under the Washington State Technology Acceptance Protocol-Ecology program is the preferred method of demonstrating that the performance standard is met. The list of certified technologies is updated as new technologies are approved (link below). Technologies with Pilot Use Level Designation and Conditional Use Level Designations are not acceptable. Refer to:

Appendix B: Storm Water Pollutant Control Hydrologic Calculations and Sizing Methods

<http://www.ecy.wa.gov/programs/wq/stormwater/newtech/technologies.html>.

Alternatively, other field scale verification of 80 percent TSS capture, such as through Technology Acceptance Reciprocity Partnership or New Jersey Corporation for Advance Testing may be acceptable. A list of field-scale verified technologies under Technology Acceptance Reciprocity Partnership Tier II and New Jersey Corporation for Advance Testing can be accessed at: <http://www.njcat.org/verification-process/technology-verification-database.html> (refer to field verified technologies only).

- (2) **The proposed BMP is designed and maintained in a manner consistent with its performance certifications (see explanation below).** The applicant must demonstrate conclusively that the proposed application of the BMP is consistent with the basis of its certification/verification. Certifications or verifications issued by the Washington Technology Acceptance Protocol-Ecology program and the Technology Acceptance Reciprocity Partnership or New Jersey Corporation for Advance Testing programs are typically accompanied by a set of guidelines regarding appropriate design and maintenance conditions that would be consistent with the certification/verification. It is common for these approvals to specify the specific model of BMP, design capacity for given unit sizes, type of media that is the basis for approval, and/or other parameters.
- (3) **The proposed BMP is acceptable at the discretion of the City Engineer.** The applicant may be required to provide additional studies and/or required to meet additional design criteria beyond the scope of this document in order to demonstrate that these criteria are met. The City Engineer has no obligation to accept any proprietary flow-through BMP.

In determining the acceptability of a proprietary flow-through treatment control BMP, the City Engineer should consider, as applicable, (a) the data submitted; (b) representativeness of the data submitted; (c) consistency of the BMP performance claims with pollutant control objectives; certainty of the BMP performance claims; (d) for projects within the public right of way and/or public projects: maintenance requirements, cost of maintenance activities, relevant previous local experience with operation and maintenance of the BMP type, ability to continue to operate the system in event that the vending company is no longer operating as a business; and (e) other relevant factors.

Appendix B: Storm Water Pollutant Control Hydrologic Calculations and Sizing Methods

B.6.2.3 Soluble-form dominated Pollutants (Nutrients)

If nutrients are identified as a most significant pollutant of concern for the PDP, then BMPs must be selected to meet the performance standard described in Appendix B.6.2.2 **and** must be selected to provide medium or high level of effectiveness for nutrient treatment as described in this section. The most common nutrient of concern in the San Diego region is nitrogen, therefore total nitrogen (TN) was used as the primary indicator of nutrient performance in storm water BMPs.

Selection of BMPs to address nutrients consists of two steps:

- 1) Determine if nutrients can be addressed via source control BMPs as described in Appendix E and Chapter 4. After applying source controls, if there are no remaining source areas for soluble nutrients, then this pollutant can be removed from the list of pollutants of concerns for the purpose of selecting flow-through treatment control BMPs. Particulate nutrients will be addressed by the performance standard in Appendix B.6.2.2.
- 2) If soluble nutrients cannot be fully addressed with source controls, then select a flow-through treatment control BMPs that meets the performance criteria in Table B.6-5 or select from the nutrient-specific menu of treatment control BMPs in Table B.6-6.
 - a. The performance standard for nitrogen removal (Table B.6-5) has been developed based on evaluation of the relative performance of available categories of non-proprietary BMPs.
 - b. For proprietary BMPs, submit third party performance data indicating that the criteria in Table B.6-5 are met. The applicant may be required to provide additional studies and/or required to meet additional design criteria beyond the scope of this document in order to demonstrate that these criteria are met. The City Engineer has no obligation to accept any proprietary flow-throughthrough BMP.

In determining the acceptability of a proprietary flow-through treatment control BMP, the City Engineer should consider, as applicable, (a) the data submitted; (b) representativeness of the data submitted; (c) consistency of the BMP performance claims with pollutant control objectives; certainty of the BMP performance claims; (d) for projects within the public right of way and/or public projects: maintenance requirements, cost of maintenance activities, relevant previous local experience with operation and maintenance of the BMP type, ability to continue to operate the system in event that the vending company is no longer operating as a business; and (e) other relevant factors.

Appendix B: Storm Water Pollutant Control Hydrologic Calculations and Sizing Methods

Table B.6-5: Performance Standard for Flow-Through Treatment Control BMPs for Nutrient Treatment

Basis	Criteria
Treatment Basis	Comparison of mean influent and effluent indicates significant concentration reduction of TN approximately 40 percent or higher based on studies with representative influent concentrations
Combined Treatment and Volume Reduction Basis	Combination of concentration reduction and volume reduction yields TN mass removal of approximately 40 percent or higher based on studies with representative influent concentrations

Table B.6-6: Flow-Through Treatment Control BMPs Meeting Nutrient Treatment Performance Standard

List of Acceptable Flow-Through Treatment Control BMPs for Nutrients	Statistical Analysis of International Stormwater BMP Database				Evaluation of Conformance to Performance Standard		
	Count In/Out	TN Mean Influent, mg/L	TN Mean Effluent ¹ , mg/L	Average Category Volume Reduct.	Volume-Adjusted Effluent Conc ² , mg/L	Volume-Adjusted Removal Efficiency ²	Level of Attainment of Performance Standard (with rationale)
Vegetated Filter Strip	138/ 122	1.53	1.37	38%	0.85	44%	Medium, if designed to include volume reduction processes
Detention Basin	90/ 89	2.34	2.01	33%	1.35	42%	Medium, if designed to include volume reduction processes
Wet Pond	397/ 425	2.12	1.33	NA	1.33	37%	Medium, best concentration reduction among BMP categories, but limited volume reduction

Source: 2014 BMP Performance Summaries and Statistical Appendices; 2010 Volume Performance Summary; available at: www.bmpdatabase.org

1 - A statistically significant difference between influent and effluent was detected at a p value of 0.05 for all categories included.

2 - Estimates were adjusted to account for category-average volume reduction.

B.6.3 Sizing Flow-Through Treatment Control BMPs:

Flow-through treatment control BMPs shall be sized to filter or treat the maximum flow rate of runoff produced from a rainfall intensity of 0.2 inch of rainfall per hour, for each hour of every storm event. The required flow-through treatment rate should be adjusted for the portion of the DCV already retained or biofiltered onsite as described in Worksheet B.6-1. The following hydrologic method shall be used to calculate the flow rate to be filtered or treated:

$$Q = C \times i \times A$$

Where:

Q = Design flow rate in cubic feet per second

C = Runoff factor, area-weighted estimate using Table B.1-1.

i = Rainfall intensity of 0.2 in/hr.

A = Tributary area (acres) which includes the total area draining to the BMP, including any offsite or onsite areas that comingle with project runoff and drain to the BMP. Refer to Section 3.3.3 for additional guidance. Street projects consult Section 1.4.3.

Worksheet B.6-1: Flow-Through Design Flows

Flow-through Design Flows		Worksheet B.6-1		
1	DCV	DCV		cubic-feet
2	DCV retained	DCV _{retained}		cubic-feet
3	DCV biofiltered	DCV _{biofiltered}		cubic-feet
4	DCV requiring flow-through (Line 1 – Line 2 – 0.67*Line 3)	DCV _{flow-through}		cubic-feet
5	Adjustment factor (Line 4 / Line 1)*	AF=		unitless
6	Design rainfall intensity	i=	0.20	in/hr
7	Area tributary to BMP (s)	A=		acres
8	Area-weighted runoff factor (estimate using Appendix B.2)	C=		unitless
9	Calculate Flow Rate = AF x (C x i x A)	Q=		cfs

- 1) Adjustment factor shall be estimated considering only retention and biofiltration BMPs located upstream of flow-through BMPs. That is, if the flow-through BMP is upstream of the project's retention and biofiltration BMPs then the flow-through BMP shall be sized using an adjustment factor of 1.
- 2) Volume based (e.g., dry extended detention basin) flow-through treatment control BMPs shall be sized to the volume in Line 4 and flow based (e.g., vegetated swales) shall be sized to flow rate in Line 9. Sand filter and media filter can be designed either by volume in Line 4 or flow rate in Line 9.
- 3) Proprietary BMPs, if used, shall provide certified treatment capacity equal to or greater than the calculated flow rate in Line 9; certified treatment capacity per unit shall be consistent with third party certifications.

Appendix

C

CITY OF VISTA BMP DESIGN MANUAL

Geotechnical and Groundwater Investigation Requirements

February 2016

Appendix C Geotechnical and Groundwater Investigation Requirements

C.1 Purpose and Phasing

Feasibility of storm water infiltration is dependent on the geotechnical and groundwater conditions at the project site.

This appendix provides guidelines for performing and reporting feasibility analysis for infiltration with respect to geotechnical and groundwater conditions. It provides framework for feasibility analysis at two phases of project development:

- **Planning Phase:** Simpler methods for conducting preliminary screening for feasibility/infeasibility, and
- **Design Phase:** When infiltration is considered potentially feasible, more rigorous analysis is needed to confirm feasibility and to develop design considerations and mitigation measures if required

Planning Phase At this stage of the project, information about the site may be limited, the proposed design features may be conceptual, and there may be an opportunity to adjust project plans to incorporate infiltration into the project layout as it is developed. At this phase, project geotechnical engineers are typically responsible for conducting explorations of geologic conditions, performing preliminary analyses, and identifying particular aspects of design that require more detailed investigation at later phases. As part of this process, the role of a planning- level infiltration feasibility assessment is to help planners reach early tentative conclusions regarding where infiltration is likely feasible, possibly feasible if done carefully, or clearly infeasible. This determination can help guide the design process by influencing project layout, selection of infiltration BMPs, and identifying if more detailed studies are necessary. The goal of the planning and feasibility phase is to identify potential geotechnical and groundwater impacts and to determine which impacts may be considered fatal flaws and which impacts may be possible to mitigate with design features. Determination of acceptable risks and/or mitigation measures may involve discussions with adjacent land owners and/or utility operators, as well as coordination with other projects under planning or design in the project vicinity. Early involvement of potentially impacted parties is critical to avoid late-stage design changes and schedule delays and to reduce potential future liabilities.

Design Phase During this phase, potential geotechnical and groundwater impacts must be fully considered and evaluated and mitigation measures should be incorporated in the BMP design, as appropriate. Mitigation measures refer to design features or assumptions intended to reduce risks associated with storm water infiltration. While rules of thumb may be useful, if applied carefully, for

Appendix C: Geotechnical and Groundwater Investigation Requirements

the planning level phase, the analyses conducted in the detailed design phase require the involvement of a geotechnical professional familiar with the local conditions. One of the first steps in the design phase should be determination if additional field and/or laboratory investigations are required (e.g., borings, test pits, laboratory or field testing) to further assess the geotechnical impacts of storm water infiltration. As the design of infiltration systems are highly dependent on the subsurface conditions, coordination with the storm water design team may be beneficial to limit duplicative efforts and costs.

Worksheet C.4-1 is provided to document infiltration feasibility screening. This worksheet is divided into two parts. Part 1 “Full Infiltration Feasibility Screening Criteria” is used to determine if the full design volume can be infiltrated onsite, whereas Part 2 “Partial Infiltration versus No Infiltration Screening Criteria” is used to determine if any amount of volume can be infiltrated.

Note that it is not necessary to investigate each and every criterion in the worksheet, a single “no” answer in Part 1 and Part 2 controls the feasibility and desirability. If all the answers in Part 1 are “yes” then it is not required to complete Part 2. The same worksheet could be used to document both planning-level categorization and design-level categorization. Note that planning-level categorization, are typically based on initial site assessment results; therefore it is not necessarily conclusive. Categorizations should be confirmed or revised, as necessary, based on more detailed design-level investigation and analysis during BMP design.

C.2 Geotechnical Feasibility Criteria

This section is divided into seven factors that should be considered, as applicable, while assessing the feasibility and desirability of infiltration related to geotechnical conditions. Note that during the planning phase, if one or more of these factors precludes infiltration as an approach, it is not necessary to assess every other factor. However, if proposing infiltration BMPs, then every applicable factor in this section must be addressed.

C.2.1 Soil and Geologic Conditions

Site soils and geologic conditions influence the rate at which water can physically enter the soils. Site assessment approaches for soil and geologic conditions may consist of:

- Review of soil survey maps
- Review of available reports on local geology to identify relevant features, such as depth to bedrock, rock type, lithology, faults, and hydrostratigraphic or confining units
- Review of previous geotechnical investigations of the area
- Site-specific geotechnical and/or geologic investigations (e.g., borings, infiltration tests)

Geologic investigations should also seek to provide an assessment of whether soil infiltration

Appendix C: Geotechnical and Groundwater Investigation Requirements

properties are likely to be uniform or variable across the project site. Appendix D provides guidance on determining infiltration rates for planning and design phase.

C.2.2 Settlement and Volume Change

Settlement and volume change limits the amount of infiltration that can be allowed without resulting in adverse impacts that cannot be mitigated. Upon considering the impacts of an infiltration design, the designer must identify areas where soil settlement or heave is likely and whether these conditions would be unfavorable to existing or proposed features. Settlement refers to the condition when soils decrease in volume, and heave refers to expansion of soils or increase in volume.

There are several different mechanisms that can induce volume change due to infiltration that the professional must be aware of and consider while completing the feasibility screening including:

- Hydro collapse and calcareous soils;
- Expansive soils;
- Frost heave;
- Consolidation; and
- Liquefaction.

C.2.3 Slope Stability

Infiltration of water has the potential to result in an increased risk of slope failure of nearby slopes. This should be assessed as part of both the feasibility and design stages of a project. There are many factors that impact the stability of slopes, including, but not limited to, slope inclination, soil and unit weight and seepage forces. Increases in moisture content or rising of the water table in the vicinity of a slope, which may result from storm water infiltration, have the potential to change the soil strength and unit weight and to add seepage forces to the slope, which in turn, may reduce the factor of safety of the stability of the slope. When evaluating the effect of infiltration on the design of a slope, the designer must consider all types of potential slope failures.

C.2.4 Utility Considerations

Utilities are either public or private infrastructure components that include underground pipelines and vaults (e.g., potable water, sewer, storm water, and gas pipelines), underground wires/conduit (e.g., telephone, cable, electrical) and above ground wiring and associated structures (e.g., electrical distribution and transmission lines). Utility considerations are typically within the purview of a geotechnical site assessment and should be considered in assessing the feasibility of storm water infiltration. Infiltration has the potential to damage subsurface utilities and/or underground utilities may pose geotechnical hazards in themselves when infiltrated water is introduced. Impacts related to storm water infiltration in the vicinity of underground utilities are not likely to cause a fatal flaw in the

Appendix C: Geotechnical and Groundwater Investigation Requirements

design, but the designer must be aware of the potential cost impacts to the design during the planning stage.

C.2.5 Groundwater Mounding

Storm water infiltration and recharge to the underlying groundwater table may create a groundwater mound beneath the infiltration facility. The height and shape of the mound depends on the infiltration system design, the recharge rate, and the hydrogeologic conditions at the site, especially the horizontal hydraulic conductivity and the saturated thickness. Elevated groundwater levels can lead to a number of problems, including flooding and damage to structures and utilities through buoyancy and moisture intrusion, increase in inflow and infiltration into municipal sanitary sewer systems, and flow of water through existing utility trenches, including sewers, potentially leading to formation of sinkholes (Gobel et al. 2004). Mounding shall be considered by the geotechnical professional while performing the infiltration feasibility screening.

C.2.6 Retaining Walls and Foundations

Development projects may include retaining walls or foundations in close proximity to proposed infiltration BMPs. These structures are designed to withstand the forces of the earth they are retaining and other surface loading conditions such as nearby structures. Foundations include shallow foundations (spread and strip footings, mats) and deep foundations (piles, piers) and are designed to support overburden and design loads. All types of retaining walls and foundations can be impacted by increased water infiltration into the subsurface as a result of potential increases in lateral pressures and potential reductions in soil strength. The geotechnical professional should consider these factors while performing the infiltration feasibility screening.

C.2.7 Other Factors

While completing the feasibility screening, other factors determined by the geotechnical professional to influence the feasibility and desirability of infiltration related to geotechnical conditions shall also be considered.

C.3 Groundwater Quality and Water Balance Feasibility Criteria

This section is divided into eight factors that should be considered, to the extent applicable, while assessing the feasibility and desirability of infiltration related to groundwater quality and water balance. Note that during the planning phase, if one or more of these factors precludes infiltration as an approach, it is not necessary to assess every other factor. However, if proposing infiltration BMPs, then every applicable factor in this section must be addressed.

C.3.1 Soil and Groundwater Contamination

Infiltration shall be avoided in areas with:

- Physical and chemical characteristics (e.g., appropriate cation exchange capacity, organic content, clay content and infiltration rate) which are not adequate for proper infiltration durations and treatment of runoff for the protection of groundwater beneficial uses.
- Groundwater contamination and/or soil pollution, if infiltration could contribute to the movement or dispersion of soil or groundwater contamination or adversely affect ongoing clean-up efforts, either onsite or down-gradient of the project.

If infiltration is under consideration for one of the above conditions, a site-specific analysis should be conducted to determine where infiltration-based BMPs can be used without adverse impacts.

C.3.2 Separation to Seasonal High Groundwater

The depth to seasonally high groundwater tables (normal high depth during the wet season) beneath the base of any infiltration BMP must be greater than 10 feet for infiltration BMPs to be allowed. The depth to groundwater requirement can be reduced from 10 feet at the discretion of the approval agency if the underlying groundwater basin does not support beneficial uses and the groundwater quality is maintained at the proposed depth. Depth to seasonally high groundwater levels can be estimated based on well level measurements or redoximorphic methods. For sites with complex groundwater tables, long term studies may be needed to understand how groundwater levels change in wet and dry years.

C.3.3 Wellhead Protection

Wellheads natural and man-made are water resources that may potentially be adversely impacted by storm water infiltration through the introduction of contaminants or alteration in water supply and levels. It is recommended that the locations of wells and springs be identified early in the design process and site design be developed to avoid infiltration in the vicinity of these resources. Infiltration BMPs must be located a minimum of 100 feet horizontally from any water supply well.

C.3.4 Contamination Risks from Land Use Activities

Concentration of storm water pollutants in runoff is highly dependent on the land uses and activities present in the area tributary to an infiltration BMP. Likewise, the potential for groundwater contamination due to the infiltration BMP is a function of pollutant abundance, concentration of pollutants in soluble forms, and the mobility of the pollutant in the subsurface soils. Hence infiltration

Appendix C: Geotechnical and Groundwater Investigation Requirements

BMPs must not be used for areas of industrial or light industrial activity, and other high threat to water quality land uses and activities as designated by each Copermittee, unless source control BMPs to prevent exposure of high threat activities are implemented, or runoff from such activities is first treated or filtered to remove pollutants prior to infiltration.

C.3.5 Consultation with Applicable Groundwater Agencies

Infiltration activities should be coordinated with the applicable groundwater management agency, such as groundwater providers and/or resource protection agencies, to ensure groundwater quality is protected. It is recommended that coordination be initiated as early as possible during the planning process to determine whether specific site assessment activities apply or whether these agencies have data available that may support the planning and design process.

C.3.6 Water Balance Impacts on Stream Flow

Use of infiltration systems to reduce surface water discharge volumes may result in additional volume of deeper infiltration compared to natural conditions, which may result in impacts to receiving channels associated with change in dry weather flow regimes. A relatively simple survey of hydrogeologic data (piezometer measurements, boring logs, regional groundwater maps) and downstream receiving water characteristics is generally adequate to determine whether there is potential for impacts and whether a more rigorous assessment is needed.

Where water balance conditions appear to be sensitive to development impacts and there is an elevated risk of impacts, a computational analysis may be warranted to evaluate the feasibility/desirability of infiltration. Such an analysis should account for precipitation, runoff, irrigation inputs, soil moisture retention, evapotranspiration, baseflow, and change in groundwater recharge on a long term basis. Because water balance calculations are sensitive to the timing of precipitation versus evapotranspiration, it is most appropriate to utilize a continuous model simulation rather than basing calculations on average annual or monthly normal conditions.

C.3.7 Downstream Water Rights

While water rights cases are not believed to be common, there may be cases in which infiltration of water from area that was previously allowed to drain freely to downstream water bodies would not be legal from a water rights perspective. Site-specific evaluation of water rights laws should be conducted if this is believed to be a potential issue in the project location.

C.3.8 Other Factors

While completing the feasibility screening, other factors determined by the geotechnical professional

Appendix C: Geotechnical and Groundwater Investigation Requirements

to influence the feasibility and desirability of infiltration related to groundwater quality and water balance shall also be considered.

C.4 Geotechnical and Groundwater Investigation Report Requirements

The geotechnical and groundwater investigation report(s) addressing onsite storm water infiltration shall include the following elements, as applicable. These reports may need to be completed by multiple professional disciplines, depending on the issues that need be addressed for a given site. It may also be necessary to prepare separate report(s) at the planning phase and design phase of a project if the methods and timing of analyses differ.

C.4.1 Site Evaluation

Site evaluation shall identify the following:

- Areas of contaminated soil or contaminated groundwater within the site;
- “Brown fields” adjacent to the site;
- Mapped soil type(s);
- Historic high groundwater level;
- Slopes steeper than 25 percent; and
- Location of water supply wells, septic systems (and expansion area), or underground storage tanks, or permitted gray water systems within 100 feet of a proposed infiltration/ percolation BMP.

C.4.2 Field Investigation

Where the site evaluation indicates potential feasibility for onsite storm water infiltration BMPs, the following field investigations will be necessary to demonstrate suitability and to provide design recommendations.

C.4.2.1 Subsurface Exploration

Subsurface exploration and testing for storm water infiltration BMPs shall include:

- A minimum of two exploratory excavations shall be conducted within 50-feet of each proposed storm water infiltration BMP. The excavations shall extend at least 10 feet below the lowest elevation of the base of the proposed infiltration BMP.
- Soils shall be logged in detail with emphasis on describing the soil profile.
- Identify low permeability or impermeable materials.

Appendix C: Geotechnical and Groundwater Investigation Requirements

- Indicate any evidence of soil contamination.

C.4.2.2 Material Testing and Infiltration/Percolation Testing

Various material testing and in situ infiltration/percolation testing methods and guidance for appropriate factor of safety are discussed in detail in Appendix D. Infiltration testing methods described in Appendix D include surface and shallow excavation methods and deeper subsurface tests.

C.4.2.3 Evaluation of Depth to Groundwater

An evaluation of the depth to groundwater is required to confirm the feasibility of infiltration. Infiltration BMPs may not be feasible in high groundwater conditions (within 10 feet of the base of infiltration/ percolation BMP) unless an exemption is granted by the approval agency.

C.4.3 Reporting Requirements by Geotechnical Engineer

The geotechnical and groundwater investigation report shall address the following key elements, and where appropriate, mitigation recommendations shall be provided.

- Identify areas of the project site where infiltration is likely to be feasible and provide justifications for selection of those areas based on soil types, slopes, proximity to existing features, etc. Include completed and signed Worksheet C.4-1.
- Investigate, evaluate and estimate the vertical infiltration rates and capacities in accordance with the guidance provided in Appendix D which describes infiltration testing and appropriate factor of safety to be applied for infiltration testing results. The site may be broken into sub-basins, each of which has different infiltration rates or capacities.
- Describe the infiltration/ percolation test results and correlation with published infiltration/ percolation rates based on soil parameters or classification. Recommend providing design infiltration/percolation rate(s) at the sub-basins. Use Worksheet D.5-1.
- Investigate the subsurface geological conditions and geotechnical conditions that would affect infiltration or migration of water toward structures, slopes, utilities, or other features. Describe the anticipated flow path of infiltrated water. Indicate if the water will flow into pavement sections, utility trench bedding, wall drains, foundation drains, or other permeable improvements.
- Investigate depth to groundwater and the nature of the groundwater. Include an estimate of the high seasonal groundwater elevations.
- Evaluate proposed use of the site (industrial use, residential use, etc.), soil and groundwater data and provide a concluding opinion whether proposed storm water infiltration could cause adverse impacts to groundwater quality and if it does cause impacts whether the impacts could be reasonably mitigated or not.

Appendix C: Geotechnical and Groundwater Investigation Requirements

- Estimate the maximum allowable infiltration rates and volumes that could occur at the site that would avoid damage to existing and proposed structures, utilities, slopes, or other features. In addition the report must indicate if the recommended infiltration rate is appropriate based on the conditions exposed during construction.
- Provide a concluding opinion regarding whether or not the proposed onsite storm water infiltration/percolation BMP will result in soil piping, daylight water seepage, slope instability, or ground settlement.
- Recommend measures to substantially mitigate or avoid any potentially detrimental effects of the storm water infiltration BMPs or associated soil response on existing or proposed improvements or structures, utilities, slopes or other features within and adjacent to the site. For example, minimize soil compaction.
- Provide guidance for the selection and location of infiltration BMPs, including the minimum separations between such infiltration BMPs and structures, streets, utilities, manufactured and existing slopes, engineered fills, utilities or other features. Include guidance for measures that could be used to reduce the minimum separations or to mitigate the potential impacts of infiltration BMPs.
- Provide a concluding opinion whether or not proposed infiltration BMPs are in conformance with the following design criteria:
 - Runoff will undergo pretreatment such as sedimentation or filtration prior to infiltration;
 - Pollution prevention and source control BMPs are implemented at a level appropriate to protect groundwater quality for areas draining to infiltration BMPs;
 - The vertical distance from the base of the infiltration BMPs to the seasonal high groundwater mark is greater than 10 feet. This vertical distance may be reduced when the groundwater basin does not support beneficial uses and the groundwater quality is maintained;
 - The soil through which infiltration is to occur has physical and chemical characteristics (e.g., appropriate cation exchange capacity, organic content, clay content, and infiltration rate) which are adequate for proper infiltration durations and treatment of runoff for the protection of groundwater beneficial uses; and
 - Infiltration BMPs are located a minimum of 100 feet horizontally from any water supply wells.

C.4.4 Reporting Requirements by the Project Design Engineer

Project design engineer has the following responsibilities:

- Complete criteria 4 and 8 in Worksheet C.4-1; and

Appendix C: Geotechnical and Groundwater Investigation Requirements

- In the SWQMP provide a concluding opinion whether or not proposed infiltration BMPs will affect seasonality of ephemeral streams.

Appendix C: Geotechnical and Groundwater Investigation Requirements

C.5 Feasibility Screening Exhibits

Table C.5-1 lists the feasibility screening exhibits that were generated using readily available GIS data sets to assist the project applicant to screen the project site for feasibility.

Table C.5-1: Feasibility Screening Exhibits

Figures	Layer	Intent/Rationale	Data Sources
C.1 Soils	Hydrologic Soil Group – A, B, C, D	Hydrologic Soil Group will aid in determining areas of potential infiltration	SanGIS http://www.sangis.org/
	Hydric Soils	Hydric soils will indicate layers of intermittent saturation that may function like a D soil and should be avoided for infiltration	USDA Web Soil Survey. Hydric soils, (ratings of 100) were classified as hydric. http://websoilsurvey.sc.egov.usda.gov/App/HomePage.htm
C.2: Slopes and Geologic Hazards	Slopes >25%	BMPs are hard to construct on slopes >25% and can potentially cause slope instability	SanGIS http://www.sangis.org/
	Liquefaction Potential	BMPs (particularly infiltration BMPs) must not be sited in areas with high potential for liquefaction or landslides to minimize earthquake/landslide risks	SanGIS http://www.sangis.org/
	Landslide Potential		SanGIS Geologic Hazards layer. Subset of polygons with hazard codes related to landslides was selected. This data is limited to the City of San Diego Boundary. http://www.sangis.org/
C.3: Groundwater Table Elevations	Groundwater Depths	Infiltration BMPs will need to be sited in areas with adequate distance (>10 ft.) from the groundwater table	GeoTracker. Data downloaded for San Diego county from 2014 and 2013. In cases where there were multiple measurements made at the same well, the average was taken over that year. http://geotracker.waterboards.ca.gov/data_download_by_county.asp
C.4: Contaminated Sites	Contaminated soils and/or groundwater sites	Infiltration must be limited in areas of contaminated soil/groundwater	GeoTracker. Data downloaded for San Diego county and limited to active cleanup sites http://geotracker.waterboards.ca.gov/

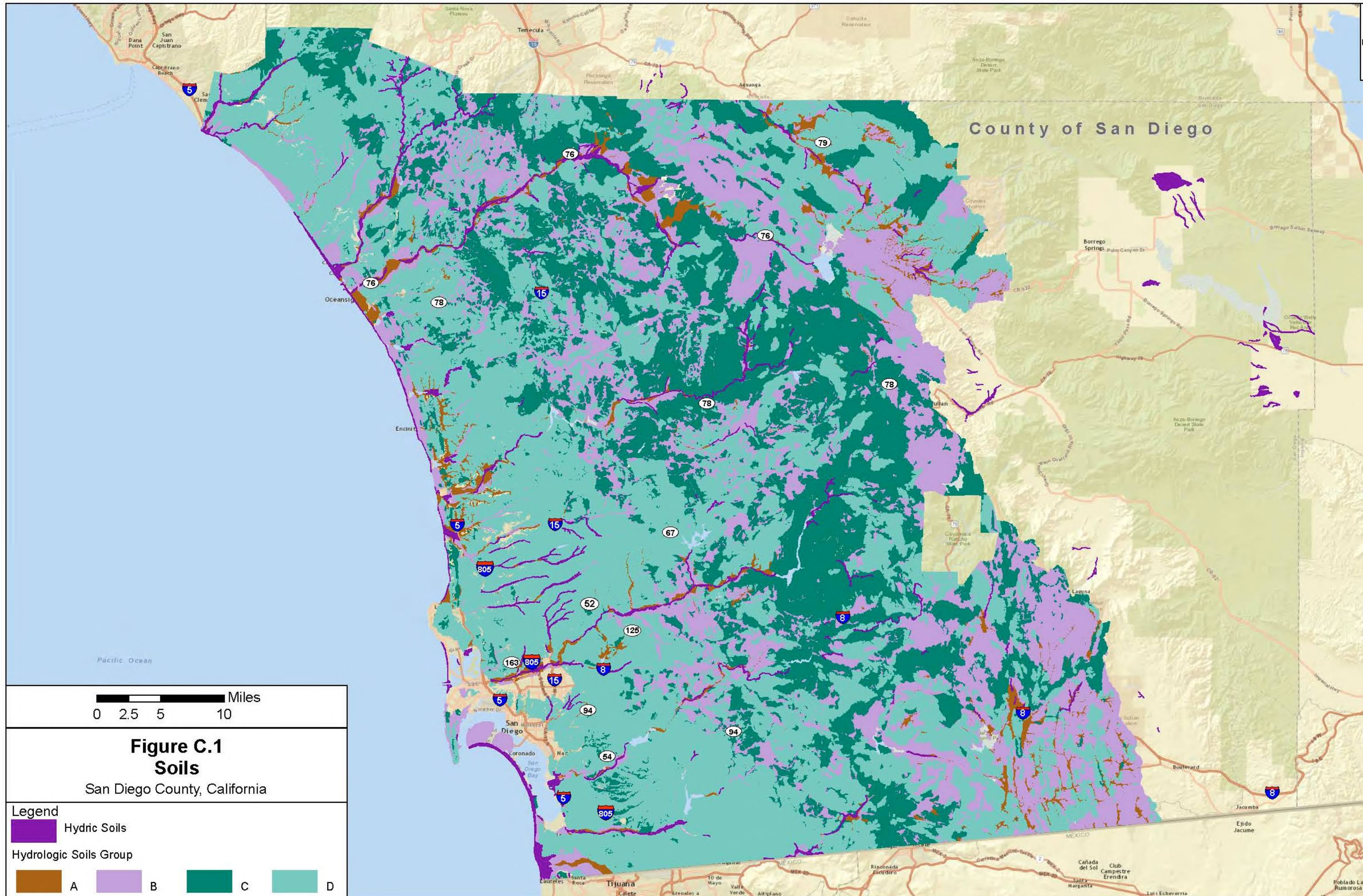

0 2.5 5 10 Miles

**Figure C.1
Soils**

San Diego County, California

Legend

 Hydric Soils

Hydrologic Soils Group

 A  B  C  D

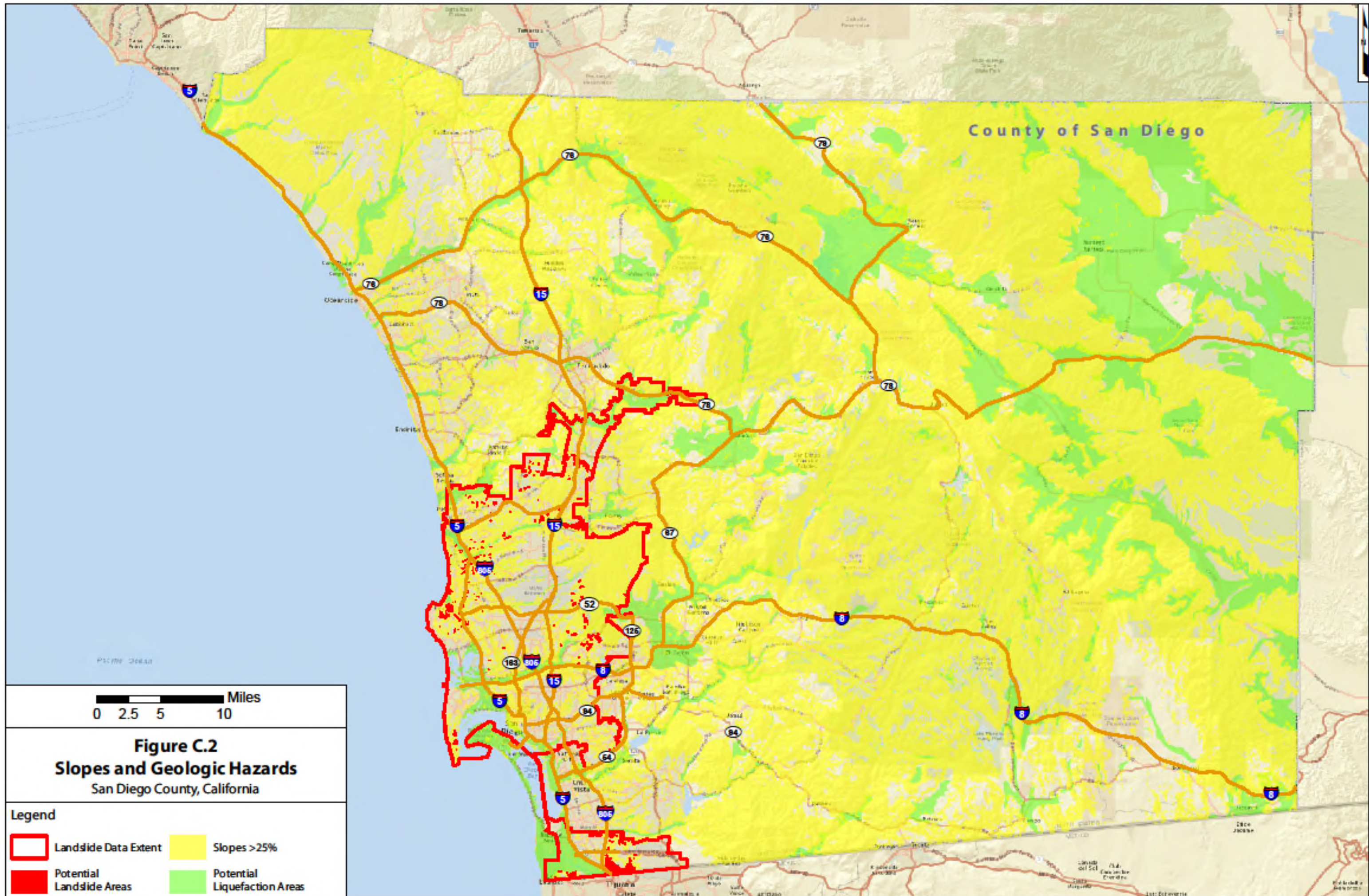

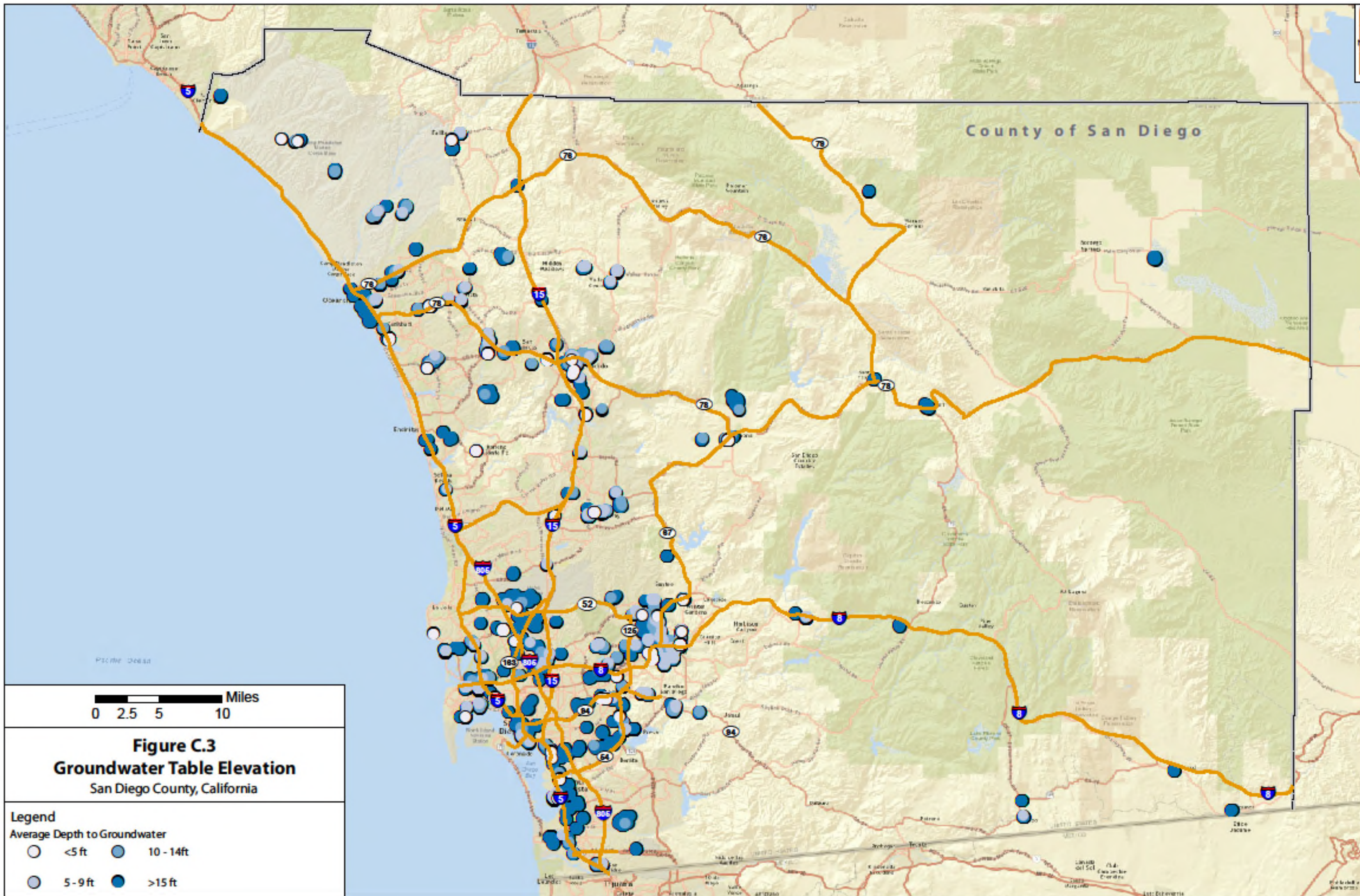

County of San Diego

Miles
0 2.5 5 10

Figure C.3
Groundwater Table Elevation
 San Diego County, California

Legend

Average Depth to Groundwater

○	<5 ft	●	10 - 14ft
○	5 - 9 ft	●	>15 ft

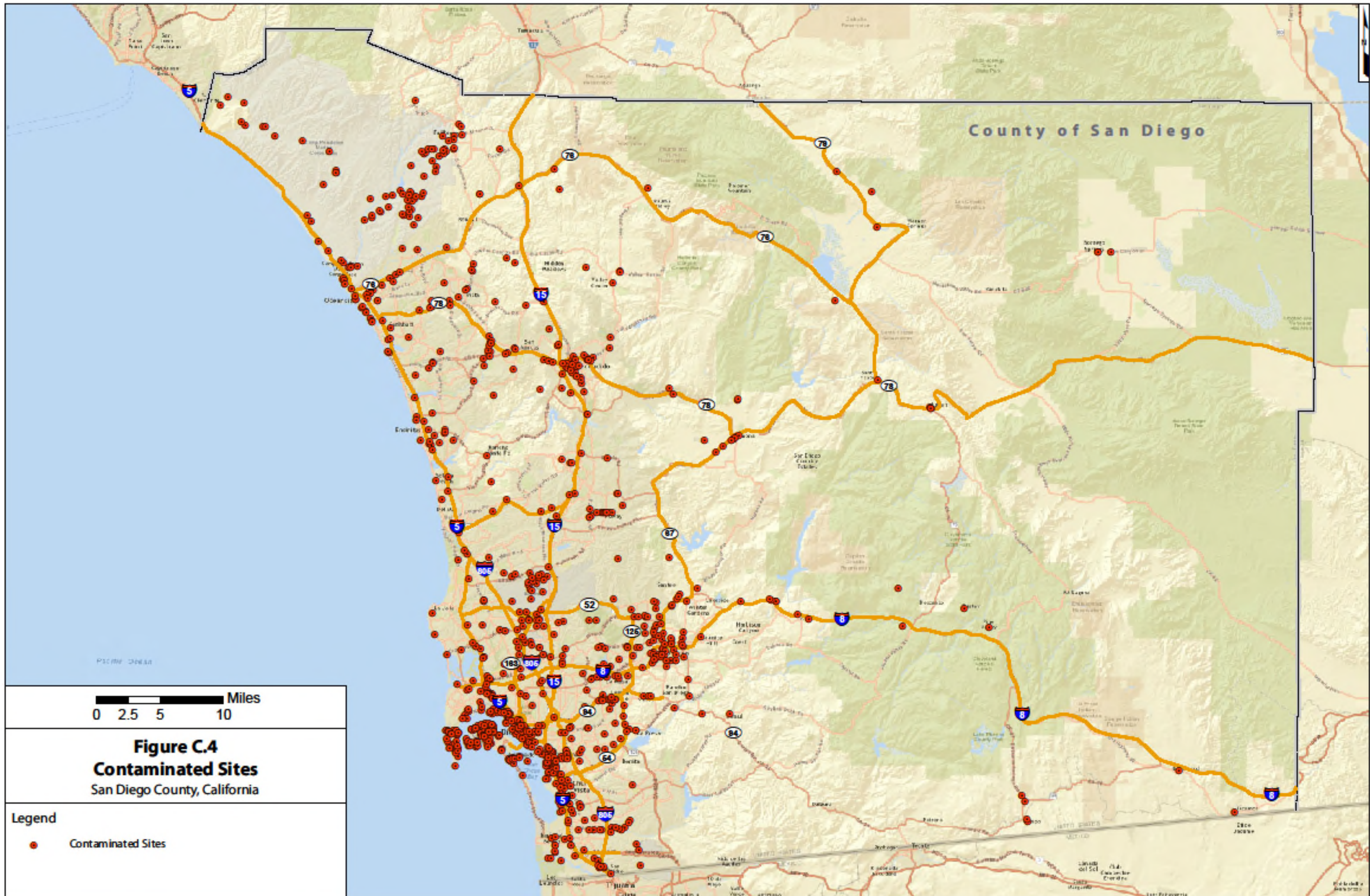

Miles
0 2.5 5 10

Figure C.4
Contaminated Sites
San Diego County, California

Legend
● Contaminated Sites

Appendix

D

CITY OF VISTA BMP DESIGN MANUAL

**Approved Infiltration Rate
Assessment Methods for
Selection of Storm Water BMPs**

Appendix D Approved Infiltration Rate Assessment Methods for Selection and Design of Storm Water BMPs

D.1 Introduction

Characterization of potential infiltration rates is a critical step in evaluating the degree to which infiltration can be used to reduce storm water runoff volume. This appendix is intended to provide guidance to help answer the following questions:

1. *How and where does infiltration testing fit into the project development process?*

Section D.2 discusses the role of infiltration testing in different stage of project development and how to plan a phased investigation approach.

2. *What infiltration rate assessment methods are acceptable?*

Section D.3 describes the infiltration rate assessment methods that are acceptable.

3. *What factors should be considered in selecting the most appropriate testing method for a project?*

Section D.4 provides guidance on site-specific considerations that influence which assessment methods are most appropriate.

4. *How should factors of safety be selected and applied to, for BMP selection and design?*

Section D.5 provides guidance for selecting a safety factor.

Note, that this appendix does not consider other feasibility criteria that may make infiltration infeasible, such as groundwater contamination and geotechnical considerations (these are covered in Appendix C). In general, infiltration testing should only be conducted after other feasibility criteria specified in this manual have been evaluated and cleared.

D.2 Role of Infiltration Testing in Different Stages of Project Development

In the process of planning and designing infiltration facilities, there are a number of ways that infiltration testing or estimation factors into project development, as summarized in Table D.2-1. As part of selecting infiltration testing methods, the geotechnical engineer shall select methods that are applicable to the phase of the project and the associated burden of proof.

Appendix D: Approved Infiltration Rate Assessment Methods

Table D.2-1: Role of Infiltration Testing

Project Phase	Key Questions/Burden of Proof	General Assessment Strategies
Site Planning Phase	<ul style="list-style-type: none"> • Where within the project area is infiltration potentially feasible? • What volume reduction approaches are potentially suitable for my project? 	<ul style="list-style-type: none"> • Use existing data and maps to the extent possible • Use less expensive methods to allow a broader area to be investigated more rapidly • Reach tentative conclusions that are subject to confirmation/refinement at the design phase
BMP Design Phase	<ul style="list-style-type: none"> • What infiltration rates should be used to design infiltration and biofiltration facilities? • What factor of safety should be applied? 	<ul style="list-style-type: none"> • Use more rigorous testing methods at specific BMP locations • Support or modify preliminary feasibility findings • Estimate design infiltration rates with appropriate factors of safety

D.3 Guidance for Selecting Infiltration Testing Methods

The geotechnical engineer shall select appropriate testing methods for the site conditions, subject to the engineer’s discretion and approval of the City Engineer, that are adequate to meet the burden of proof that is applicable at each phase of the project design (See Table D.3-1):

- At the planning phase, testing/evaluation method must be selected to provide a reliable estimate of the locations where infiltration is feasible and allow a reasonably confident determination of infiltration feasibility to support the selection between full infiltration, partial infiltration, and no infiltration BMPs.
- At the design phase, the testing method must be selected to provide a reliable infiltration rate to be used in design. The degree of certainty provided by the selected test should be considered

Table D.3-1 provides a matrix comparison of these methods. Sections D.3.1 to D.3.3 provide a summary of each method. This appendix is not intended to be an exhaustive reference on infiltration testing at this time. It does not attempt to discuss every method for testing, nor is it intended to provide step-by-step procedures for each method. The user is directed to supplemental resources (referenced in this appendix) or other appropriate references for more specific information. **Alternative testing methods are allowed with appropriate rationales, subject to the discretion**

Appendix D: Approved Infiltration Rate Assessment Methods

of the City Engineer.

In order to select an infiltration testing method, it is important to understand how each test is applied and what specific physical properties the test is designed to measure. Infiltration testing methods vary considerably in these regards. For example, a borehole percolation test is conducted by drilling a borehole, filling a portion of the hole with water, and monitoring the rate of fall of the water. This test directly measures the three dimensional flux of water into the walls and bottom of the borehole. An approximate correction is applied to indirectly estimate the vertical hydraulic conductivity from the results of the borehole test. In contrast, a double-ring infiltrometer test is conducted from the ground surface and is intended to provide a direct estimate of vertical (one-dimensional) infiltration rate at this point. Both of these methods are applicable under different conditions.

Table D.3-1: Comparison of Infiltration Rate Estimation and Testing Methods

Test	Suitability at Planning Level Screening Phase	Suitability at BMP Design Phase
NRCS Soil Survey Maps	Yes, but mapped soil types must be confirmed with site observations. Regional soil maps are known to contain inaccuracies at the scale of typical development sites.	No, unless a strong correlation is developed between soil types and infiltration rates in the direct vicinity of the site and an elevated factor of safety is used.
Grain Size Analysis	Not preferred. Should only be used if a strong correlation has been developed between grain size analysis and measured infiltration rates testing results of site soils.	No
Cone Penetrometer Testing	Not preferred. Should only be used if a strong correlation has been developed between CPT results and measured infiltration rates testing results of site soils.	No
Simple Open Pit Test	Yes	Yes, with appropriate correction for infiltration into side walls and elevated factor of safety.
Open Pit Falling Head Test	Yes	Yes, with appropriate correction for infiltration into side walls and elevated factor of safety.
Double Ring Infiltrometer Test (ASTM 3385)	Yes	Yes
Single Ring Infiltrometer Test	Yes	Yes

Appendix D: Approved Infiltration Rate Assessment Methods

Test	Suitability at Planning Level Screening Phase	Suitability at BMP Design Phase
Large-scale Pilot Infiltration Test	Yes, but generally cost prohibitive and too water-intensive for preliminary screening of a large area.	Yes, but should consider relatively large water demand associated with this test.
Smaller-scale Pilot Infiltration Test	Yes	Yes
Well Permeameter Method (USBR 7300-89)	Yes; reliability of this test can be improved by obtaining a continuous core where tests are conducted.	Yes in areas of proposed cut where other tests are not possible; a continuous boring log should be recorded and used to interpret test; should be confirmed with a more direct measurement following excavation.
Borehole Percolation Tests (various methods)	Yes; reliability of this test can be improved by obtaining a continuous core where tests are conducted.	Yes in areas of proposed cut where other tests are not possible; a continuous boring log should be recorded and used to interpret test; should be confirmed with a more direct measurement following excavation.
Laboratory Permeability Tests (e.g., ASTM D2434)	Yes, only suitable for evaluating potential infiltration rates in proposed fill areas. For sites with proposed cut, it is preferred to do a borehole percolation test at the proposed grade instead of analyzing samples in the lab. A combination of both tests may improve reliability.	No. However, may be part of a line of evidence for estimating the design infiltration of partial infiltration BMPs constructed in future compacted fill.

D.3.1 Desktop Approaches and Data Correlation Methods

This section reviews common methods used to evaluate infiltration characteristics based on desktop-available information, such as GIS data. This section also introduces methods for estimating infiltration properties via correlations with other measurements.

D.3.1.1 NRCS Soil Survey Maps

NRCS Soil Survey maps (<http://websoilsurvey.nrcs.usda.gov/app/HomePage.htm>) can be used to estimate preliminary feasibility conditions, specifically by mapping hydrologic soil groups, soil texture classes, and presence of hydric soils relative to the site layout. For feasibility determinations, mapped conditions must be supplemented with available data from the site (e.g., soil borings, observed soil textures, biological indicators). The presence of D soils, if confirmed by available data, provides a reasonable basis to determine that full infiltration is not feasible for a given DMA.

D.3.1.2 Grain Size Analysis Testing and Correlations to Infiltration Rate

Hydraulic conductivity can be estimated indirectly from correlations with soil grain-size distributions.

Appendix D: Approved Infiltration Rate Assessment Methods

While this method is approximate, correlations have been relatively well established for some soil conditions. One of the most commonly used correlations between grain size parameters and hydraulic conductivity is the Hazen (1892, 1911) empirical formula (Philips and Kitch, 2011), but a variety of others have been developed. Correlations must be developed based on testing of site-specific soils.

D.3.1.3 Cone Penetrometer Testing and Correlations to Infiltration Rate

Hydraulic conductivity can also be estimated indirectly from cone penetrometer testing (CPT). A cone penetrometer test involves advancing a small probe into the soil and measuring the relative resistance encountered by the probe as it is advanced. The signal returned from this test can be interpreted to yield estimated soil types and the location of key transitions between soil layers. If this method is used, correlations must be developed based on testing of site-specific soils.

D.3.2 Surface and Shallow Excavation Methods

This section describes tests that are conducted at the ground surface or within shallow excavations close to the ground surface. These tests are generally applicable for cases where the bottom of the infiltration system will be near the existing ground surface. They can also be conducted to confirm the results of borehole methods after excavation/site grading has been completed.

D.3.2.1 Simple Open Pit Test

The Simple Open Pit Test is most appropriate for planning level screening of infiltration feasibility. Although it is similar to Open Pit Falling Head tests used for establishing a design infiltration rate (see below), the Simple Open Pit Test is less rigorous and is generally conducted to a lower standard of care. This test can be conducted by a nonprofessional as part of planning level screening phase.

The Simple Open Pit Test is a falling head test in which a hole at least two feet in diameter is filled with water to a level of 6" above the bottom. Water level is checked and recorded regularly until either an hour has passed or the entire volume has infiltrated. The test is repeated two more times in succession and the rate at which the water level falls in the third test is used as the infiltration rate.

This test has the advantage of being inexpensive to conduct. Yet it is believed to be fairly reliable for screening as the dimensions of the test are similar, proportionally, to the dimensions of a typical BMP. The key limitations of this test are that it measures a relatively small area, does not necessarily result in a precise measurement, and may not be uniformly implemented.

Source: City of Portland, 2008. Storm water Management Manual

D.3.2.2 Open Pit Falling Head Test

This test is similar to the Simple Open Pit Test, but covers a larger footprint, includes more specific

Appendix D: Approved Infiltration Rate Assessment Methods

instructions, returns more precise measurements, and generally should be overseen by a geotechnical professional. Nonetheless, it remains a relatively simple test.

To perform this test, a hole is excavated at least 2 feet wide by 4 feet long (larger is preferred) and to a depth of at least 12 inches. The bottom of the hole should be approximately at the depth of the proposed infiltrating surface of the BMP. The hole is pre-soaked by filling it with water at least a foot above the soil to be tested and leaving it at least 4 hours (or overnight if clays are present). After pre-soaking, the hole is refilled to a depth of 12 inches and allow it to drain for one hour (2 hours for slower soils), measuring the rate at which the water level drops. The test is then repeated until successive trials yield a result with less than 10 percent change.

In comparison to a double-ring infiltrometer, this test has the advantage of measuring infiltration over a larger area and better resembles the dimensionality of a typical small scale BMP. Because it includes both vertical and lateral infiltration, it should be adjusted to estimate design rates for larger scale BMPs.

D.3.2.3 Double Ring Infiltrometer Test (ASTM 3385)

The Double Ring Infiltrometer was originally developed to estimate the saturated hydraulic conductivity of low permeability materials, such as clay liners for ponds, but has seen significant use in storm water applications. The most recent revision of this method from 2009 is known as ASTM 3385-09. The testing apparatus is designed with concentric rings that form an inner ring and an annulus between the inner and outer rings. Infiltration from the annulus between the two rings is intended to saturate the soil outside of the inner ring such that infiltration from the inner ring is restricted primarily to the vertical direction.

To conduct this test, both the center ring and annulus between the rings are filled with water. There is no pre-wetting of the soil in this test. However, a constant head of 1 to 6 inches is maintained for 6 hours, or until a constant flow rate is established. Both the inner flow rate and annular flow rate are recorded, but if they are different, the inner flow rate should be used. There are a variety of approaches that are used to maintain a constant head on the system, including use of a Mariotte tube, constant level float valves, or manual observation and filling. This test must be conducted at the elevation of the proposed infiltrating surface; therefore application of this test is limited in cases where the infiltration surface is a significant distance below existing grade at the time of testing.

This test is generally considered to provide a direct estimate of vertical infiltration rate for the specific point tested and is highly replicable. However, given the small diameter of the inner ring (standard diameter is 12 inches, but it can be larger), this test only measures infiltration rate in a small area. Additionally, given the small quantity of water used in this test compared to larger scale tests, this test may be biased high in cases where the long term infiltration rate is governed by groundwater mounding and the rate at which mounding dissipates (i.e., the capacity of the infiltration receptor). Finally, the added effort and cost of isolating vertical infiltration rate may not necessarily be warranted considering that BMPs typically have a lateral component of infiltration as well. Therefore, while this method has

Appendix D: Approved Infiltration Rate Assessment Methods

the advantages of being technical rigorous and well standardized, it should not necessarily be assumed to be the most representative test for estimating full-scale infiltration rates. Source: American Society for Testing and Materials (ASTM) International (2009)

D.3.2.4 Single Ring Infiltrometer Test

The single ring infiltrometer test is not a standardized ASTM test, however it is a relatively well-controlled test and shares many similarities with the ASTM standard double ring infiltrometer test (ASTM 3385-09). This test is a constant head test using a large ring (preferably greater than 40 inches in diameter) usually driven 12 inches into the soil. Water is ponded above the surface. The rate of water addition is recorded and infiltration rate is determined after the flow rate has stabilized. Water can be added either manually or automatically.

The single ring used in this test tends to be larger than the inner ring used in the double ring test. Driving the ring into the ground limits lateral infiltration; however some lateral infiltration is generally considered to occur. Experience in Riverside County (CA) has shown that this test gives results that are close to full-scale infiltration facilities. The primary advantages of this test are that it is relatively simple to conduct and has a larger footprint (compared to the double-ring method) and restricts horizontal infiltration and is more standardized (compared to open pit methods). However, it is still a relatively small scale test and can only be reasonably conducted near the existing ground surface.

D.3.2.5 Large-scale Pilot Infiltration Test

As its name implies, this test is closer in scale to a full-scale infiltration facility. This test was developed by Washington State Department of Ecology specifically for storm water applications.

To perform this test, a test pit is excavated with a horizontal surface area of roughly 100 square feet to a depth that allows 3 to 4 feet of ponding above the expected bottom of the infiltration facility. Water is continually pumped into the system to maintain a constant water level (between 3 and 4 feet about the bottom of the pit, but not more than the estimated water depth in the proposed facility) and the flow rate is recorded. The test is continued until the flow rate stabilizes. Infiltration rate is calculated by dividing the flow rate by the surface area of the pit. Similar to other open pit test, this test is known to result in a slight bias high because infiltration also moves laterally through the walls of the pit during the test. Washington State Department of Ecology requires a correction factor of 0.75 (factor of safety of 1.33) be applied to results.

This test has the advantage of being more resistant to bias from localized soil variability and being more similar to the dimensionality and scale of full scale BMPs. It is also more likely to detect long term decline in infiltration rates associated with groundwater mounding. As such, it remains the preferred test for establishing design infiltration rates in Western Washington (Washington State Department of Ecology, 2012). In a comparative evaluation of test methods, this method was found to provide a more reliable estimate of full-scale infiltration rate than double ring infiltrometer and

Appendix D: Approved Infiltration Rate Assessment Methods

borehole percolation tests (Philips and Kitch 2011).

The difficulty encountered in this method is that it requires a larger area be excavated than the other methods, and this in turn requires larger equipment for excavation and a greater supply of water. However, this method should be strongly considered when less information is known about spatial variability of soils and/or a higher degree of certainty in estimated infiltration rates is desired.

Source: Washington State Department of Ecology, 2012.

D.3.2.6 Smaller-scale Pilot Infiltration Test

The smaller-scale PIT is conducted similarly to the large-scale PIT but involves a smaller excavation, ranging from 20 to 32 square feet instead of 100 square feet for the large-scale PIT, with similar depths. The primary advantage of this test compared to the full-scale PIT is that it requires less excavation volume and less water. It may be more suitable for small-scale distributed infiltration controls where the need to conduct a greater number of tests outweighs the accuracy that must be obtained in each test, and where groundwater mounding is not as likely to be an issue. Washington State Department of Ecology establishes a correction factor of 0.5 (factor of safety of 2.0) for this test in comparison to 0.75 (factor of safety of 1.33) for the large-scale PIT to account for a greater fraction of water infiltrating through the walls of the excavation and lower degree of certainty related to spatial variability of soils.

D.3.3 Deeper Subsurface Tests

D.3.3.1 Well Permeameter Method (USBR 7300-89)

Well permeameter methods were originally developed for purposes of assessing aquifer permeability and associated yield of drinking water wells. This family of tests is most applicable in situations in which infiltration facilities will be placed substantially below existing grade, which limits the use of surface testing methods.

In general, this test involves drilling a 6 inch to 8 inch test well to the depth of interest and maintaining a constant head until a constant flow rate has been achieved. Water level is maintained with down-hole floats. The Porchet method or the nomographs provided in the USBR Drainage Manual (United States Department of the Interior, Bureau of Reclamation, 1993) are used to convert the measured rate of percolation to an estimate of vertical hydraulic conductivity. A smaller diameter boring may be adequate, however this then requires a different correction factor to account for the increased variability expected.

While these tests have applicability in screening level analysis, considerable uncertainty is introduced in the step of converting direct percolation measurements to estimates of vertical infiltration. Additionally, this testing method is prone to yielding erroneous results cases where the vertical horizon

Appendix D: Approved Infiltration Rate Assessment Methods

of the test intersects with minor lenses of sandy soils that allow water to dissipate laterally at a much greater rate than would be expected in a full-scale facility. To improve the interpretation of this test method, a continuous bore log should be inspected to determine whether thin lenses of material may be biasing results at the strata where testing is conducted. Consult USBR procedure 7300-89 for more details.

Source: (United States Department of the Interior, Bureau of Reclamation, 1990, 1993)

D.3.3.2 Borehole Percolation Tests (various methods)

Borehole percolation tests were originally developed as empirical tests to estimate the capacity of onsite sewage disposal systems (septic system leach fields), but have more recently been adopted into use for evaluating storm water infiltration. Similar to the well permeameter method, borehole percolation methods primarily measure lateral infiltration into the walls of the boring and are designed for situations in which infiltration facilities will be placed well below current grade. The percolation rate obtained in this test should be converted to an infiltration rate using a technique such as the Porchet method.

This test is generally implemented similarly to the USBR Well Permeameter Method. Per the Riverside County Borehole Percolation method, a hole is bored to a depth at least 5 times the borehole radius. The hole is presoaked for 24 hours (or at least 2 hours if sandy soils with no clay). The hole is filled to approximately the anticipated top of the proposed infiltration basin. Rates of fall are measured for six hours, refilling each half hour (or 10 minutes for sand). Tests are generally repeated until consistent results are obtained.

The same limitations described for the well permeameter method apply to borehole percolation tests, and their applicability is generally limited to initial screening. To improve the interpretation of this test method, a continuous soil core can be extracted from the hole and below the test depth, following testing, to determine whether thin lenses of material may be biasing results at the strata where testing is conducted.

Sources: Riverside County Percolation Test (2011), California Test 750 (Caltrans, 1986), San Bernardino County Percolation Test (1992); USEPA Falling Head Test (USEPA, 1980).

D.4 Specific Considerations for Infiltration Testing

The following subsections are intended to address specific topics that commonly arise in characterizing infiltration rates.

D.4.1 Hydraulic Conductivity versus Infiltration Rate versus Percolation Rate

A common misunderstanding is that the “percolation rate” obtained from a percolation test is equivalent to the “infiltration rate” obtained from tests such as a single or double ring infiltrometer test which is equivalent to the “saturated hydraulic conductivity”. In fact, these terms have different meanings. Saturated hydraulic conductivity is an intrinsic property of a specific soil sample under a given degree of compaction. It is a coefficient in Darcy’s equation (Darcy 1856) that characterizes the flux of water that will occur under a given gradient. The measurement of saturated hydraulic conductivity in a laboratory test is typically referred to as “permeability”, which is a function of the density, structure, stratification, fines, and discontinuities of a given sample under given controlled conditions. In contrast, infiltration rate is an empirical observation of the rate of flux of water into a given soil structure under long term ponding conditions. Similarly to permeability, infiltration rate can be limited by a number of factors including the layering of soil, density, discontinuities, and initial moisture content. These factors control how quickly water can move through a soil. However, infiltration rate can also be influenced by mounding of groundwater, and the rate at which water dissipates horizontally below a BMP – both of which describe the “capacity” of the “infiltration receptor” to accept this water over an extended period. For this reason, an infiltration test should ideally be conducted for a relatively long duration resembling a series of storm events so that the capacity of the infiltration receptor is evaluated as well as the rate at which water can enter the system. Infiltration rates are generally tested with larger diameter holes, pits, or apparatuses intended to enforce a primarily vertical direction of flux.

In contrast, percolation is tested with small diameter holes, and it is mostly a lateral phenomenon. The direct measurement yielded by a percolation test tends to overestimate the infiltration rate, except perhaps in cases in which a BMP has similar dimensionality to the borehole, such as a dry well. Adjustment of percolation rates may be made to an infiltration rate using a technique such as the Porchet Method.

D.4.2 Cut and Fill Conditions

Cut Conditions: Where the proposed infiltration BMP is to be located in a cut condition, the infiltration surface level at the bottom of the BMP might be far below the existing grade. For example, if the infiltration surface of a proposed BMP is to be located at an elevation that is currently beneath 15 feet of planned cut, *how can the proposed infiltration surface be tested to establish a design infiltration rate prior to beginning excavation?* The question can be addressed in two ways: First, one of the deeper subsurface tests described above can be used to provide a planning level screening of potential rates at the elevation of the proposed infiltrating surface. These tests can be conducted at depths exceeding 100 feet, therefore are applicable in most cut conditions. Second, the project can commit to further testing using more reliable methods following bulk excavation to refine or adjust infiltration rates, and/or

Appendix D: Approved Infiltration Rate Assessment Methods

apply higher factors of safety to borehole methods to account for the inherent uncertainty in these measurements and conversions.

Fill Conditions: There are two types of fills – those that are engineered or documented, and those that are undocumented. Undocumented fills are fills placed without engineering controls or construction quality assurance and are subject to great uncertainty. Engineered fills are generally placed using construction quality assurance procedures and may have criteria for grain-size and fines content, and the properties can be very well understood. However, for engineered fills, infiltration rates may still be quite uncertain due to layering and heterogeneities introduced as part of construction that cannot be precisely controlled.

If the bottom of a BMP (infiltration surface) is proposed to be located in a fill location, the infiltration surface may not exist prior to grading. How then can the infiltration rate be determined? For example, if a proposed infiltration BMP is to be located with its bottom elevation in 10 feet of fill, how could one reasonably establish an infiltration rate prior to the fill being placed?

Where possible, infiltration BMPs on fill material should be designed such that their infiltrating surface extends into native soils. Additionally, for shallow fill depths, fill material can be selectively graded (i.e., high permeability granular material placed below proposed BMPs) to provide reliable infiltration properties until the infiltrating water reaches native soils. In some cases, due to considerable fill depth, the extension of the BMP down to natural soil and/or selective grading of fill material may prove infeasible. In addition, fill material will result in some compaction of now buried native soils potentially reducing their ability to infiltrate. In these cases, because of the uncertainty of fill parameters as described above as well as potential compaction of the native soils, an infiltration BMP may not be feasible.

If the source of fill material is defined and this material is known to be of a granular nature and that the native soils below is permeable and will not be highly compacted, infiltration through compacted fill materials may still be feasible. In this case, a project phasing approach could be used including the following general steps, (1) collect samples from areas expected to be used as borrow sites for fill activities, (2) remold samples to approximately the proposed degree of compaction and measure the saturated hydraulic conductivity of remolded samples using laboratory methods, (3) if infiltration rates appear adequate for infiltration, then apply an appropriate factor of safety and use the initial rates for preliminary design, (4) following placement of fill, conduct in-situ testing to refine design infiltration rates and adjust the design as needed; the infiltration rate of native soil below the fill should also be tested at this time to determine if compaction as a result of fill placement has significantly reduced its infiltration rate. The project geotechnical engineer should be involved in decision making whenever infiltration is proposed in the vicinity of engineered fill structures so that potential impacts of infiltration on the strength and stability of fills and pavement structures can be evaluated.

D.4.3 Effects of Direct and Incidental Compaction

It is widely recognized that compaction of soil has a major influence on infiltration rates (Pitt et al. 2008). However, direct (intentional) compaction is an essential aspect of project construction and indirect compaction (such as by movement of machinery, placement of fill, stockpiling of materials, and foot traffic) can be difficult to avoid in some parts of the project site. Infiltration testing strategies should attempt to measure soils at a degree of compaction that resembles anticipated post-construction conditions.

Ideally, infiltration systems should be located outside of areas where direct compaction will be required and should be staked off to minimize incidental compaction from vehicles and stockpiling. For these conditions, no adjustment of test results is needed.

However, in some cases, infiltration BMPs will be constructed in areas to be compacted. For these areas, it may be appropriate to include field compaction tests or prepare laboratory samples and conducting infiltration testing to approximate the degree of compaction that will occur in post-construction conditions. Alternatively, testing could be conducted on undisturbed soil, and an additional factor of safety could be applied to account for anticipated infiltration after compaction. To develop a factor of safety associated with incidental compaction, samples could be compacted to various degrees of compaction, their hydraulic conductivity measured, and a “response curve” developed to relate the degree of compaction to the hydraulic conductivity of the material.

D.4.4 Temperature Effects on Infiltration Rate

The rate of infiltration through soil is affected by the viscosity of water, which in turn is affected by the temperature of water. As such, infiltration rate is strongly dependent on the temperature of the infiltrating water (Cedergren, 1997). For example, Emerson (2008) found that wintertime infiltration rates below a BMP in Pennsylvania were approximately half their peak summertime rates. As such, it is important to consider the effects of temperature when planning tests and interpreting results.

If possible, testing should be conducted at a temperature that approximates the typical runoff temperatures for the site during the times when rainfall occurs. If this is not possible, then the results of infiltration tests should be adjusted to account for the difference between the temperature at the time of testing and the typical temperature of runoff when rainfall occurs. The measured infiltration can be adjusted by the ratio of the viscosity at the test temperature versus the typical temperature when rainfall occurs (Cedergren, 1997), per the following formula:

$$K_{\text{Typical}} = K_{\text{Test}} \times \left(\frac{\mu_{\text{Test}}}{\mu_{\text{Typical}}} \right)$$

Where:

K_{Typical} = the typical infiltration rate expected at typical temperatures when rainfall occurs

Appendix D: Approved Infiltration Rate Assessment Methods

K_{Test} = the infiltration rate measured or estimated under the conditions of the test

μ_{Typical} = the viscosity of water at the typical temperature expected when rainfall occurs

μ_{Test} = the viscosity of water at the temperature at which the test was conducted

D.4.5 Number of Infiltration Tests Needed

The heterogeneity inherent in soils implies that all but the smallest proposed infiltration facilities would benefit from infiltration tests in multiple locations. The following requirements apply for in situ infiltration/percolation testing:

- In situ infiltration/ percolation testing shall be conducted at a minimum of two locations within 50-feet of each proposed storm water infiltration/ percolation BMP.
- In situ infiltration/percolation testing shall be conducted using an approved method listed in Table D.3-1
- Testing shall be conducted at approximately the same depth and in the same material as the base of the proposed storm water BMP.

D.5 Selecting a Safety Factor

Monitoring of actual facility performance has shown that the full-scale infiltration rate can be much lower than the rate measured by small-scale testing (King County Department of Natural Resources and Parks, 2009). Factors such as soil variability and groundwater mounding may be responsible for much of this difference. Additionally, the infiltration rate of BMPs naturally declines between maintenance cycles as the BMP surface becomes occluded and particulates accumulate in the infiltrative layer.

Should I use a factor of safety for design infiltration rate?

In the past, infiltration structures have been shown to have a relatively short lifespan. Over 50 percent of infiltration systems either partially or completely failed within the first 5 years of operation (United States EPA, 1999). In a Maryland study on infiltration trenches (Lindsey et al. 1991), 53 percent were not operating as designed, 36 percent were clogged, and 22 percent showed reduced filtration. In a study of 12 infiltration basins (Galli 1992), none of which had built-in pretreatment systems, all had failed within the first two years of operation.

Given the known potential for infiltration BMPs to degrade or fail over time, an appropriate factor of safety applied to infiltration testing results is strongly recommended. This section presents a recommended thought process for selecting a safety factor. This method considers factor of safety to be a function of:

- Site suitability considerations, and
- Design-related considerations.

Appendix D: Approved Infiltration Rate Assessment Methods

These factors and the method for using them to compute a safety factor are discussed below. Importantly, this method encourages rigorous site investigation, good pretreatment, and commitments to routine maintenance to provide technically-sound justification for using a lower factor of safety.

D.5.1 Determining Factor of Safety

Worksheet D.5-1, at the end of this section can be used in conjunction with Tables D.5-1 and D.5-2 to determine an appropriate safety factor. Tables D.5-1 and D.5-2 assign point values to design considerations; the values are entered into Worksheet D.5-1, which assign a weighting factor for each design consideration.

The following procedure can be used to estimate an appropriate factor of safety to be applied to the infiltration testing results. When assigning a factor of safety, care should be taken to understand what other factors of safety are implicit in other aspects of the design to avoid incorporating compounding factors of safety that may result in significant over-design.

1. For each consideration shown above, determine whether the consideration is a high, medium, or low concern.
2. For all high concerns in Table D.5-1, assign a factor value of 3, for medium concerns, assign a factor value of 2, and for low concerns assign a factor value of 1.
3. Multiply each of the factors in Table D.5-1 by 0.25 and then add them together. This should yield a number between 1 and 3.
4. For all high concerns in Table D.5-2, assign a factor value of 3, for medium concerns, assign a factor value of 2, and for low concerns assign a factor value of 1.
5. Multiply each of the factors in Table D.5-2 by 0.5 and then add them together. This should yield a number between 1 and 3.
6. Multiply the two safety factors together to get the final combined safety factor. If the combined safety factor is less than 2, then 2 should be used as the safety factor.
7. Divide the tested infiltration rate by the combined safety factor to obtain the adjusted design infiltration rate for use in sizing the infiltration facility.

Note: The minimum combined adjustment factor should not be less than 2.0 and the maximum combined adjustment factor should not exceed 9.0.

D.5.2 Site Suitability Considerations for Selection of an Infiltration Factor of Safety

Considerations related to site suitability include:

Appendix D: Approved Infiltration Rate Assessment Methods

- Soil assessment methods – the site assessment extent (e.g., number of borings, test pits, etc.) and the measurement method used to estimate the short-term infiltration rate.
- Predominant soil texture/percent fines – soil texture and the percent of fines can influence the potential for clogging. Finer grained soils may be more susceptible to clogging.
- Site soil variability – site with spatially heterogeneous soils (vertically or horizontally) as determined from site investigations are more difficult to estimate average properties for resulting in a higher level of uncertainty associated with initial estimates.
- Depth to seasonal high groundwater/impervious layer – groundwater mounding may become an issue during excessively wet conditions where shallow aquifers or shallow clay lenses are present.

These considerations are summarized in Table D.5-1 below, in addition to presenting classification of concern.

Table D.5-1: Suitability Assessment Related Considerations for Infiltration Facility Safety Factors

Consideration	High Concern – 3 points	Medium Concern – 2 points	Low Concern – 1 point
Assessment methods (see explanation below)	Use of soil survey maps or simple texture analysis to estimate short-term infiltration rates Use of well permeameter or borehole methods without accompanying continuous boring log Relatively sparse testing with direct infiltration methods	Use of well permeameter or borehole methods with accompanying continuous boring log Direct measurement of infiltration area with localized infiltration measurement methods (e.g., infiltrometer) Moderate spatial resolution	Direct measurement with localized (i.e., small-scale) infiltration testing methods at relatively high resolution ¹ or Use of extensive test pit infiltration measurement methods ²
Texture Class	Silty and clayey soils with significant fines	Loamy soils	Granular to slightly loamy soils
Site soil variability	Highly variable soils indicated from site assessment, or Unknown variability	Soil borings/test pits indicate moderately homogeneous soils	Soil borings/test pits indicate relatively homogeneous soils
Depth to groundwater/ impervious layer	<5 ft. below facility bottom	5-15 ft. below facility bottom	>15 below facility bottom

1 - Localized (i.e., small scale) testing refers to methods such as the double-ring infiltrometer and borehole tests)

2 - Extensive infiltration testing refers to methods that include excavating a significant portion of the proposed infiltration area, filling the excavation with water, and monitoring drawdown. The excavation should be to the depth of the proposed infiltration surface and ideally be at least 30 to 100 square feet.

D.5.3 Design Related Considerations for Selection of an Infiltration Factor of Safety

Design related considerations include:

- Level of pretreatment and expected influent sediment loads – credit should be given for good pretreatment to account for the reduced probability of clogging from high sediment loading. Appendix B.6 describes performance criteria for “flow-through treatment” based 80 percent capture of total suspended solids, which provides excellent levels of pretreatment. Additionally, the Washington State Technology Acceptance Protocol-Ecology provides a certification for “pre-treatment” based on 50 percent removal of TSS, which provides moderate levels of treatment. Current approved technologies are listed at: <http://www.ecy.wa.gov/programs/wq/stormwater/newtech/technologies.html>. Use of certified technologies can allow a lower factor of safety. Also, facilities designed to capture runoff from relatively clean surfaces such as rooftops are likely to see low sediment loads and therefore may be designed with lower safety factors. Finally, the amount of landscaped area and its vegetation coverage characteristics should be considered. For example in arid areas with more soils exposed, open areas draining to infiltration systems may contribute excessive sediments.
- Compaction during construction – proper construction oversight is needed during construction to ensure that the bottoms of infiltration facility are not impacted by significant incidental compaction. Facilities that use proper construction practices and oversight need less restrictive safety factors.

Table D.5-2: Design Related Considerations for Infiltration Facility Safety Factors

Consideration	High Concern – 3 points	Medium Concern – 2 points	Low Concern – 1 point
Level of pretreatment/ expected influent sediment loads	Limited pretreatment using gross solids removal devices only, such as hydrodynamic separators, racks and screens AND tributary area includes landscaped areas, steep slopes, high traffic areas, road sanding, or any other areas expected to produce high sediment, trash, or debris loads.	Good pretreatment with BMPs that mitigate coarse sediments such as vegetated swales AND influent sediment loads from the tributary area are expected to be moderate (e.g., low traffic, mild slopes, stabilized pervious areas, etc.). Performance of pretreatment consistent with “pretreatment BMP performance criteria” (50% TSS removal) in Appendix B.6	Excellent pretreatment with BMPs that mitigate fine sediments such as bioretention or media filtration OR sedimentation or facility only treats runoff from relatively clean surfaces, such as rooftops/non-sanded road surfaces. Performance of pretreatment consistent with “flow-through treatment control BMP performance criteria” (i.e., 80% TSS removal) in Appendix B.6

Appendix D: Approved Infiltration Rate Assessment Methods

Consideration	High Concern – 3 points	Medium Concern – 2 points	Low Concern – 1 point
Redundancy/ resiliency	No “backup” system is provided; the system design does not allow infiltration rates to be restored relatively easily with maintenance	The system has a backup pathway for treated water to discharge if clogging occurs <u>or</u> infiltration rates can be restored via maintenance.	The system has a backup pathway for treated water to discharge if clogging occurs <u>and</u> infiltration rates can be relatively easily restored via maintenance.
Compaction during construction	Construction of facility on a compacted site or increased probability of unintended/ indirect compaction.	Medium probability of unintended/ indirect compaction.	Equipment traffic is effectively restricted from infiltration areas during construction and there is low probability of unintended/ indirect compaction.

D.5.4 Implications of a Factor of Safety in BMP Feasibility and Design

The above method will provide safety factors in the range of 2 to 9. From a simplified practical perspective, this means that the size of the facility will need to increase in area from 2 to 9 times relative to that which might be used without a safety factor. Clearly, numbers toward the upper end of this range will make all but the best locations prohibitive in land area and cost.

In order to make BMPs more feasible and cost effective, steps should be taken to plan and execute the implementation of infiltration BMPs in a way that will reduce the safety factors needed for those projects. A commitment to effective site design and source control thorough site investigation, use of effective pretreatment controls, good construction practices, and restoration of the infiltration rates of soils that are damaged by prior compaction should lower the safety factor that should be applied, to help improve the long term reliability of the system and reduce BMP construction cost. While these practices decrease the recommended safety factor, they do not totally mitigate the need to apply a factor of safety. The minimum recommended safety factor of 2.0 is intended to account for the remaining uncertainty and long-term deterioration that cannot be technically mitigated.

Because there is potential for an applicant to “exaggerate” factor of safety to artificially prove infeasibility, an upper cap on the factor of safety is proposed for feasibility screening. A maximum factor of safety of 2.0 is recommended for infiltration feasibility screening such that an artificially high factor of safety cannot be used to inappropriately rule out infiltration, unless justified. If the site passes the feasibility analysis at a factor of safety of 2.0, then infiltration must investigated, but a higher factor of safety may be selected at the discretion of the design engineer.

Appendix D: Approved Infiltration Rate Assessment Methods

Worksheet D.5-1: Factor of Safety and Design Infiltration Rate Worksheet

Factor of Safety and Design Infiltration Rate Worksheet		Worksheet D.5-1			
Factor Category		Factor Description	Assigned Weight (w)	Factor Value (v)	Product (p) $p = w \times v$
A	Suitability Assessment	Soil assessment methods	0.25		
		Predominant soil texture	0.25		
		Site soil variability	0.25		
		Depth to groundwater / impervious layer	0.25		
		Suitability Assessment Safety Factor, $S_A = \Sigma p$			
B	Design	Level of pretreatment/ expected sediment loads	0.5		
		Redundancy/resiliency	0.25		
		Compaction during construction	0.25		
		Design Safety Factor, $S_B = \Sigma p$			
Combined Safety Factor, $S_{total} = S_A \times S_B$					
Observed Infiltration Rate, inch/hr, $K_{observed}$ (corrected for test-specific bias)					
Design Infiltration Rate, in/hr, $K_{design} = K_{observed} / S_{total}$					
Supporting Data					
Briefly describe infiltration test and provide reference to test forms:					

Appendix



CITY OF VISTA BMP DESIGN MANUAL

BMP Design Fact Sheets

Appendix E BMP Design Fact Sheets

The following fact sheets were developed to assist the project applicants with designing BMPs to meet the storm water obligations:

MS4 Category	Manual Category	Design Fact Sheet
Source Control	Source Control	SC: Source Control BMP Requirements
Site Design	Site Design	SD-1: Street Trees SD-5: Impervious Area Dispersion SD-6A: Green Roofs SD-6B: Permeable Pavement (Site Design BMP) SD-8: Rain Barrels
Retention	Harvest and Use	HU-1: Cistern
	Infiltration	INF-1: Infiltration Basins INF-2: Bioretention INF-3: Permeable Pavement (Pollutant Control)
	Partial Retention	PR-1: Biofiltration with Partial Retention
Biofiltration	Biofiltration	BF-1: Biofiltration BF-2: Nutrient Sensitive Media Design BF-3: Proprietary Biofiltration
Flow-through Treatment Control	Flow-through Treatment Control with Alternative Compliance	FT-1: Vegetated Swales FT-2: Media Filters FT-3: Sand Filters FT-4: Dry Extended Detention Basin FT-5: Proprietary Flow-through Treatment Control
		PL: Plant List

E.1 Source Control BMP Requirements

Worksheet E.1-1: Source Control BMP Requirements

How to comply: Projects shall comply with this requirement by implementing all source control BMPs listed in this section that are applicable to their project. Applicability shall be determined through consideration of the development project's features and anticipated pollutant sources. Appendix E.1 provides guidance for identifying source control BMPs applicable to a project. Checklist I.4 in Appendix I shall be used to document compliance with source control BMP requirements.

How to use this worksheet:

1. Review Column 1 and identify which of these potential sources of storm water pollutants apply to your site. Check each box that applies.
2. Review Column 2 and incorporate all of the corresponding applicable BMPs in your project site plan.
3. Review Columns 3 and 4 and incorporate all of the corresponding applicable permanent controls and operational BMPs in a table in your project-specific storm water management report. Describe your specific BMPs in an accompanying narrative, and explain any special conditions or situations that required omitting BMPs or substituting alternatives.

If These Sources Will Be on the Project Site Then Your SWQMP Shall Consider These Source Control BMPs		
1 Potential Sources of Runoff Pollutants	2 Permanent Controls—Show on Drawings	3 Permanent Controls—List in Table and Narrative	4 Operational BMPs—Include in Table and Narrative
<ul style="list-style-type: none"> <input type="checkbox"/> A. Onsite storm drain inlets <input type="checkbox"/> Not Applicable 	<ul style="list-style-type: none"> <input type="checkbox"/> Locations of inlets. 	<ul style="list-style-type: none"> <input type="checkbox"/> Mark all inlets with the words “No Dumping! Flows to Bay” or similar. 	<ul style="list-style-type: none"> <input type="checkbox"/> Maintain and periodically repaint or replace inlet markings. <input type="checkbox"/> Provide storm water pollution prevention information to new site owners, lessees, or operators. <input type="checkbox"/> See applicable operational BMPs in Fact Sheet SC-44, “Drainage System Maintenance,” in the CASQA Stormwater Quality Handbooks at www.cabmphandbooks.com. <input type="checkbox"/> Include the following in lease agreements: “Tenant shall not allow anyone to discharge anything to storm drains or to store or deposit materials so as to create a potential discharge to storm drains.”

If These Sources Will Be on the Project Site Then Your SWQMP shall consider These Source Control BMPs		
1 Potential Sources of Runoff Pollutants	2 Permanent Controls—Show on Drawings	3 Permanent Controls—List in Table and Narrative	4 Operational BMPs—Include in Table and Narrative
<input type="checkbox"/> B. Interior floor drains and elevator shaft sump pumps <input type="checkbox"/> Not Applicable		<input type="checkbox"/> State that interior floor drains and elevator shaft sump pumps will be plumbed to sanitary sewer.	<input type="checkbox"/> Inspect and maintain drains to prevent blockages and overflow.
<input type="checkbox"/> C. Interior parking garages <input type="checkbox"/> Not Applicable		<input type="checkbox"/> State that parking garage floor drains will be plumbed to the sanitary sewer.	<input type="checkbox"/> Inspect and maintain drains to prevent blockages and overflow.
<input type="checkbox"/> D1. Need for future indoor & structural pest control <input type="checkbox"/> Not Applicable		<input type="checkbox"/> Note building design features that discourage entry of pests.	<input type="checkbox"/> Provide Integrated Pest Management information to owners, lessees, and operators.

If These Sources Will Be on the Project Site Then Your SWQMP shall consider These Source Control BMPs		
1 Potential Sources of Runoff Pollutants	2 Permanent Controls—Show on Drawings	3 Permanent Controls—List in Table and Narrative	4 Operational BMPs—Include in Table and Narrative
<ul style="list-style-type: none"> <input type="checkbox"/> D2. Landscape/Outdoor Pesticide Use <input type="checkbox"/> Not Applicable 	<ul style="list-style-type: none"> <input type="checkbox"/> Show locations of existing trees or areas of shrubs and ground cover to be undisturbed and retained. <input type="checkbox"/> Show self-retaining landscape areas, if any. <input type="checkbox"/> Show storm water treatment facilities. 	<p>State that final landscape plans will accomplish all of the following.</p> <ul style="list-style-type: none"> <input type="checkbox"/> Preserve existing drought tolerant trees, shrubs, and ground cover to the maximum extent possible. <input type="checkbox"/> Design landscaping to minimize irrigation and runoff, to promote surface infiltration where appropriate, and to minimize the use of fertilizers and pesticides that can contribute to storm water pollution. <input type="checkbox"/> Where landscaped areas are used to retain or detain storm water, specify plants that are tolerant of periodic saturated soil conditions. <input type="checkbox"/> Consider using pest-resistant plants, especially adjacent to hardscape. <input type="checkbox"/> To ensure successful establishment, select plants appropriate to site soils, slopes, climate, sun, wind, rain, land use, air movement, ecological consistency, and plant interactions. 	<ul style="list-style-type: none"> <input type="checkbox"/> Maintain landscaping using minimum or no pesticides. <input type="checkbox"/> See applicable operational BMPs in Fact Sheet SC-41, “Building and Grounds Maintenance,” in the CASQA Stormwater Quality Handbooks at www.cabmphandbooks.com. <input type="checkbox"/> Provide IPM information to new owners, lessees and operators.

If These Sources Will Be on the Project Site Then Your SWQMP shall consider These Source Control BMPs		
1 Potential Sources of Runoff Pollutants	2 Permanent Controls—Show on Drawings	3 Permanent Controls—List in Table and Narrative	4 Operational BMPs—Include in Table and Narrative
<ul style="list-style-type: none"> <input type="checkbox"/> E. Pools, spas, ponds, decorative fountains, and other water features. <input type="checkbox"/> Not Applicable 	<ul style="list-style-type: none"> <input type="checkbox"/> Show location of water feature and a sanitary sewer cleanout in an accessible area within 10 feet. 	<ul style="list-style-type: none"> <input type="checkbox"/> If the local municipality requires pools to be plumbed to the sanitary sewer, place a note on the plans and state in the narrative that this connection will be made according to local requirements. 	<ul style="list-style-type: none"> <input type="checkbox"/> See applicable operational BMPs in Fact Sheet SC-72, “Fountain and Pool Maintenance,” in the CASQA Stormwater Quality Handbooks at www.cabmphandbooks.com.
<ul style="list-style-type: none"> <input type="checkbox"/> F. Food service <input type="checkbox"/> Not Applicable 	<ul style="list-style-type: none"> <input type="checkbox"/> For restaurants, grocery stores, and other food service operations, show location (indoors or in a covered area outdoors) of a floor sink or other area for cleaning floor mats, containers, and equipment. <input type="checkbox"/> On the drawing, show a note that this drain will be connected to a grease interceptor before discharging to the sanitary sewer. 	<ul style="list-style-type: none"> <input type="checkbox"/> Describe the location and features of the designated cleaning area. <input type="checkbox"/> Describe the items to be cleaned in this facility and how it has been sized to ensure that the largest items can be accommodated. 	

If These Sources Will Be on the Project Site Then Your SWQMP shall consider These Source Control BMPs		
1 Potential Sources of Runoff Pollutants	2 Permanent Controls—Show on Drawings	3 Permanent Controls—List in Table and Narrative	4 Operational BMPs—Include in Table and Narrative
<ul style="list-style-type: none"> <input type="checkbox"/> G. Refuse areas <input type="checkbox"/> Not Applicable 	<ul style="list-style-type: none"> <input type="checkbox"/> Show where site refuse and recycled materials will be handled and stored for pickup. See local municipal requirements for sizes and other details of refuse areas. <input type="checkbox"/> If dumpsters or other receptacles are outdoors, show how the designated area will be covered, graded, and paved to prevent run- on and show locations of berms to prevent runoff from the area. Also show how the designated area will be protected from wind dispersal. <input type="checkbox"/> Any drains from dumpsters, compactors, and tallow bin areas shall be connected to a grease removal device before discharge to sanitary sewer. 	<ul style="list-style-type: none"> <input type="checkbox"/> State how site refuse will be handled and provide supporting detail to what is shown on plans. <input type="checkbox"/> State that signs will be posted on or near dumpsters with the words “Do not dump hazardous materials here” or similar. 	<ul style="list-style-type: none"> <input type="checkbox"/> State how the following will be implemented: Provide adequate number of receptacles. Inspect receptacles regularly; repair or replace leaky receptacles. Keep receptacles covered. Prohibit/prevent dumping of liquid or hazardous wastes. Post “no hazardous materials” signs. Inspect and pick up litter daily and clean up spills immediately. Keep spill control materials available on- site. See Fact Sheet SC-34, “Waste Handling and Disposal” in the CASQA Stormwater Quality Handbooks at www.cabmphandbooks.com.

If These Sources Will Be on the Project Site Then Your SWQMP shall consider These Source Control BMPs		
1 Potential Sources of Runoff Pollutants	2 Permanent Controls—Show on Drawings	3 Permanent Controls—List in Table and Narrative	4 Operational BMPs—Include in Table and Narrative Table and Narrative
<input type="checkbox"/> H. Industrial processes. <input type="checkbox"/> Not Applicable	<input type="checkbox"/> Show process area.	<input type="checkbox"/> If industrial processes are to be located onsite, state: “All process activities to be performed indoors. No processes to drain to exterior or to storm drain system.”	<input type="checkbox"/> See Fact Sheet SC-10, “Non-Stormwater Discharges” in the CASQA Stormwater Quality Handbooks at www.cabmphandbooks.com .
<input type="checkbox"/> I. Outdoor storage of equipment or materials. (See rows J and K for source control measures for vehicle cleaning, repair, and maintenance.) <input type="checkbox"/> Not Applicable	<input type="checkbox"/> Show any outdoor storage areas, including how materials will be covered. Show how areas will be graded and bermed to prevent run-on or runoff from area and protected from wind dispersal. <input type="checkbox"/> Storage of non-hazardous liquids shall be covered by a roof and/or drain to the sanitary sewer system, and be contained by berms, dikes, liners, or vaults. <input type="checkbox"/> Storage of hazardous materials and wastes must be in compliance with the local hazardous materials ordinance and a Hazardous Materials Management Plan for the site.	<input type="checkbox"/> Include a detailed description of materials to be stored, storage areas, and structural features to prevent pollutants from entering storm drains. Where appropriate, reference documentation of compliance with the requirements of local Hazardous Materials Programs for: <ul style="list-style-type: none"> ▪ Hazardous Waste Generation ▪ Hazardous Materials Release Response and Inventory ▪ California Accidental Release Prevention Program ▪ Aboveground Storage Tank ▪ Uniform Fire Code Article 80 Section 103(b) & (c) 1991 ▪ Underground Storage Tank 	<input type="checkbox"/> See the Fact Sheets SC-31, “Outdoor Liquid Container Storage” and SC-33, “Outdoor Storage of Raw Materials” in the CASQA Stormwater Quality Handbooks at www.cabmphandbooks.com .

If These Sources Will Be on the Project Site Then Your SWQMP shall consider These Source Control BMPs		
1 Potential Sources of Runoff Pollutants	2 Permanent Controls—Show on Drawings	3 Permanent Controls—List in Table and Narrative	4 Operational BMPs—Include in Table and Narrative
<ul style="list-style-type: none"> <input type="checkbox"/> J. Vehicle and Equipment Cleaning <input type="checkbox"/> Not Applicable 	<ul style="list-style-type: none"> <input type="checkbox"/> Show on drawings as appropriate: <ol style="list-style-type: none"> (1) Commercial/industrial facilities having vehicle /equipment cleaning needs shall either provide a covered, bermed area for washing activities or discourage vehicle/equipment washing by removing hose bibs and installing signs prohibiting such uses. (2) Multi-dwelling complexes shall have a paved, bermed, and covered car wash area (unless car washing is prohibited onsite and hoses are provided with an automatic shut-off to discourage such use). (3) Washing areas for cars, vehicles, and equipment shall be paved, designed to prevent run-on to or runoff from the area, and plumbed to drain to the sanitary sewer. (4) Commercial car wash facilities shall be designed such that no runoff from the facility is discharged to the storm drain system. Wastewater from the facility shall discharge to the sanitary sewer, or a wastewater reclamation system shall be installed. 	<ul style="list-style-type: none"> <input type="checkbox"/> If a car wash area is not provided, describe measures taken to discourage onsite car washing and explain how these will be enforced. 	<p>Describe operational measures to implement the following (if applicable):</p> <ul style="list-style-type: none"> <input type="checkbox"/> Wash water from vehicle and equipment washing operations shall not be discharged to the storm drain system. <input type="checkbox"/> Car dealerships and similar may rinse cars with water only. <input type="checkbox"/> See Fact Sheet SC-21, “Vehicle and Equipment Cleaning,” in the CASQA Stormwater Quality Handbooks at www.cabmphandbooks.com

If These Sources Will Be on the Project Site Then Your SWQMP shall consider These Source Control BMPs		
1 Potential Sources of Runoff Pollutants	2 Permanent Controls—Show on Drawings	3 Permanent Controls—List in Table and Narrative	4 Operational BMPs—Include in Table and Narrative
<ul style="list-style-type: none"> <input type="checkbox"/> K. Vehicle/Equipment Repair and Maintenance <input type="checkbox"/> Not Applicable 	<ul style="list-style-type: none"> <input type="checkbox"/> Accommodate all vehicle equipment repair and maintenance indoors. Or designate an outdoor work area and design the area to protect from rainfall, run-on runoff, and wind dispersal. <input type="checkbox"/> Show secondary containment for exterior work areas where motor oil, brake fluid, gasoline, diesel fuel, radiator fluid, acid-containing batteries or other hazardous materials or hazardous wastes are used or stored. Drains shall not be installed within the secondary containment areas. <input type="checkbox"/> Add a note on the plans that states either (1) there are no floor drains, or (2) floor drains are connected to wastewater pretreatment systems prior to discharge to the sanitary sewer and an industrial waste discharge permit will be obtained. 	<ul style="list-style-type: none"> <input type="checkbox"/> State that no vehicle repair or maintenance will be done outdoors, or else describe the required features of the outdoor work area. <input type="checkbox"/> State that there are no floor drains or if there are floor drains, note the agency from which an industrial waste discharge permit will be obtained and that the design meets that agency's requirements. <input type="checkbox"/> State that there are no tanks, containers or sinks to be used for parts cleaning or rinsing or, if there are, note the agency from which an industrial waste discharge permit will be obtained and that the design meets that agency's requirements. 	<p>In the report, note that all of the following restrictions apply to use the site:</p> <ul style="list-style-type: none"> <input type="checkbox"/> No person shall dispose of, nor permit the disposal, directly or indirectly of vehicle fluids, hazardous materials, or rinse water from parts cleaning into storm drains. <input type="checkbox"/> No vehicle fluid removal shall be performed outside a building, nor on asphalt or ground surfaces, whether inside or outside a building, except in such a manner as to ensure that any spilled fluid will be in an area of secondary containment. Leaking vehicle fluids shall be contained or drained from the vehicle immediately. <input type="checkbox"/> No person shall leave unattended drip parts or other open containers containing vehicle fluid, unless such containers are in use or in an area of secondary containment.

If These Sources Will Be on the Project Site Then Your SWQMP shall consider These Source Control BMPs		
1 Potential Sources of Runoff Pollutants	2 Permanent Controls—Show on Drawings	3 Permanent Controls—List in Table and Narrative	4 Operational BMPs—Include in Table and Narrative
<ul style="list-style-type: none"> <input type="checkbox"/> L. Fuel Dispensing Areas <input type="checkbox"/> Not Applicable 	<ul style="list-style-type: none"> <input type="checkbox"/> Fueling areas¹ shall have impermeable floors (i.e., portland cement concrete or equivalent smooth impervious surface) that are (1) graded at the minimum slope necessary to prevent ponding; and (2) separated from the rest of the site by a grade break that prevents run-on of storm water to the MEP. <input type="checkbox"/> Fueling areas shall be covered by a canopy that extends a minimum of ten feet in each direction from each pump. [Alternative: The fueling area must be covered and the cover’s minimum dimensions must be equal to or greater than the area within the grade break or fuel dispensing area¹.] The canopy [or cover] shall not drain onto the fueling area. 		<ul style="list-style-type: none"> <input type="checkbox"/> The property owner shall dry sweep the fueling area routinely. <input type="checkbox"/> See the Business Guide Sheet, “Automotive Service—Service Stations” in the CASQA Stormwater Quality Handbooks at www.cabmphandbooks.com.

1. The fueling area shall be defined as the area extending a minimum of 6.5 feet from the corner of each fuel dispenser or the length at which the hose and nozzle assembly may be operated plus a minimum of one foot, whichever is greater.

If These Sources Will Be on the Project Site Then Your SWQMP shall consider These Source Control BMPs		
1 Potential Sources of Runoff Pollutants	2 Permanent Controls—Show on Drawings	3 Permanent Controls—List in Table and Narrative	4 Operational BMPs—Include in Table and Narrative
<p>M. Loading Docks</p> <ul style="list-style-type: none"> <input type="checkbox"/> Not Applicable 	<ul style="list-style-type: none"> <input type="checkbox"/> Show a preliminary design for the loading dock area, including roofing and drainage. Loading docks shall be covered and/or graded to minimize run-on to and runoff from the loading area. Roof downspouts shall be positioned to direct storm water away from the loading area. Water from loading dock areas should be drained to the sanitary sewer where feasible. Direct connections to storm drains from depressed loading docks are prohibited. <input type="checkbox"/> Loading dock areas draining directly to the sanitary sewer shall be equipped with a spill control valve or equivalent device, which shall be kept closed during periods of operation. <input type="checkbox"/> Provide a roof overhang over the loading area or install door skirts (cowling) at each bay that enclose the end of the trailer. 		<ul style="list-style-type: none"> <input type="checkbox"/> Move loaded and unloaded items indoors as soon as possible. <input type="checkbox"/> See Fact Sheet SC-30, “Outdoor Loading and Unloading,” in the CASQA Stormwater Quality Handbooks at www.cabmphandbooks.com.

If These Sources Will Be on the Project Site Then Your SWQMP shall consider These Source Control BMPs		
1 Potential Sources of Runoff Pollutants	2 Permanent Controls—Show on Drawings	3 Permanent Controls—List in Table and Narrative	4 Operational BMPs—Include in Table and Narrative
<ul style="list-style-type: none"> <input type="checkbox"/> N. Fire Sprinkler Test Water <input type="checkbox"/> Not Applicable 		<ul style="list-style-type: none"> <input type="checkbox"/> Provide a means to drain fire sprinkler test water to the sanitary sewer. 	<ul style="list-style-type: none"> <input type="checkbox"/> See the note in Fact Sheet SC-41, “Building and Grounds Maintenance,” in the CASQA Stormwater Quality Handbooks at www.cabmphandbooks.com.
<ul style="list-style-type: none"> <input type="checkbox"/> O. Miscellaneous Drain or Wash Water <ul style="list-style-type: none"> <input type="checkbox"/> Boiler drain lines <input type="checkbox"/> Condensate drain lines <input type="checkbox"/> Rooftop equipment <input type="checkbox"/> Drainage sumps <input type="checkbox"/> Roofing, gutters, and trim <input type="checkbox"/> Not Applicable 		<ul style="list-style-type: none"> <input type="checkbox"/> Boiler drain lines shall be directly or indirectly connected to the sanitary sewer system and may not discharge to the storm drain system. <input type="checkbox"/> Condensate drain lines may discharge to landscaped areas if the flow is small enough that runoff will not occur. Condensate drain lines may not discharge to the storm drain system. <input type="checkbox"/> Rooftop mounted equipment with potential to produce pollutants shall be roofed and/or have secondary containment. <input type="checkbox"/> Any drainage sumps onsite shall feature a sediment sump to reduce the quantity of sediment in pumped water. <input type="checkbox"/> Avoid roofing, gutters, and trim made of copper or other unprotected metals that may leach into runoff. 	

If These Sources Will Be on the Project Site Then Your SWQMP shall consider These Source Control BMPs		
1 Potential Sources of Runoff Pollutants	2 Permanent Controls—Show on Drawings	3 Permanent Controls—List in Table and Narrative	4 Operational BMPs—Include in Table and Narrative
<input type="checkbox"/> P. Plazas, sidewalks, and parking lots. <input type="checkbox"/> Not Applicable			<input type="checkbox"/> Plazas, sidewalks, and parking lots shall be swept regularly to prevent the accumulation of litter and debris. Debris from pressure washing shall be collected to prevent entry into the storm drain system. Wash water containing any cleaning agent or degreaser shall be collected and discharged to the sanitary sewer and not discharged to a storm drain.

E.2 SD-1 Street Trees



Street Trees (Source: County of San Diego LID Manual – EOA, Inc.)

MS4 Permit Category

Site Design

Manual Category

Site Design

Applicable Performance Standard

Site Design

Primary Benefits

Volume Reduction

Description

Trees planted to intercept rainfall and runoff can be used as storm water management measures that provide additional benefits beyond those typically associated with trees, including energy conservation, air quality improvement, and aesthetic enhancement. Typical storm water management benefits associated with trees include:

- **Interception of rainfall** – tree surfaces (roots, foliage, bark, and branches) intercept, evaporate, store, or convey precipitation to the soil before it reaches surrounding impervious surfaces
- **Reduced erosion** – trees protect denuded area by intercepting or reducing the velocity of rain drops as they fall through the tree canopy
- **Increased infiltration** – soil conditions created by roots and fallen leaves promote infiltration
- **Treatment of storm water** – trees provide treatment through uptake of nutrients and other storm water pollutants (phytoremediation) and support of other biological processes that break down pollutants

Typical street tree system components include:

- Trees of the appropriate species for site conditions and constraints
- Available growing space based on tree species, soil type, water availability, surrounding land uses, and project goals
- Optional suspended pavement design to provide structural support for adjacent pavement

without requiring compaction of underlying layers

- Optional root barrier devices as needed; a root barrier is a device installed in the ground, between a tree and the sidewalk, intended to guide roots down and away from the sidewalk in order to prevent sidewalk lifting from tree roots.
- Optional tree grates; to be considered to maximize available space for pedestrian circulation and to protect tree roots from compaction related to pedestrian circulation; tree grates are typically made up of porous material that will allow the runoff to soak through.
- Optional shallow surface depression for ponding of excess runoff
- Optional planter box drain

Design Adaptations for Project Goals

Site design BMP to provide incidental treatment. Street trees primarily functions as site design BMPs for incidental treatment. Benefits from street trees are accounted for by adjustment factors presented in Appendix B.2. This credit can apply to non-street trees as well (that meet the same criteria). Trees as a site design BMP are only credited up to 0.25 times the DCV from the project footprint (with a maximum single tree credit volume of 400 ft³).

Storm water pollutant control BMP to provide treatment. Applicants are allowed to design trees as a pollutant control BMP and obtain credit greater than 0.25 times the DCV from the project footprint (or a credit greater than 400 ft³ from a single tree). For this option to be approved by the [City Engineer], applicant is required to do infiltration feasibility screening (Appendix C and D) and provide calculations supporting the amount of credit claimed from implementing trees within the project footprint. The [City Engineer] has the discretion to request additional analysis before approving credits greater than 0.25 times the DCV from the project footprint (or a credit greater than 400 ft³ from a single tree).

Design Criteria and Considerations

Street Trees must meet the following design criteria and considerations. Deviations from the below criteria may be approved at the discretion of the City Engineer if it is determined to be appropriate:

<i>Siting and Design</i>	<i>Intent/Rationale</i>
<input type="checkbox"/> Tree species is appropriately chosen for the development (private or public). For public rights-of-ways, local planning guidelines and zoning provisions for the permissible species and placement of trees are consulted. A list of trees appropriate for site design that can be used by all county municipalities are provided in Appendix E.20	Proper tree placement and species selection minimizes problems such as pavement damage by surface roots and poor growth.

Siting and Design

Intent/Rationale

Location of trees planted along public streets follows local requirements and guidelines. Vehicle and pedestrian line of sight are considered in tree selection and placement. Unless exemption is granted by the City Engineer the following minimum tree separation distance is followed

Improvement	Minimum distance to Street Tree
Traffic Signal, Stop sign	20 feet
Underground Utility lines (except sewer)	5 feet
Sewer Lines	10 feet
Above ground utility structures (Transformers, Hydrants, Utility poles, etc.)	10 feet
Driveways	10 feet
Intersections (intersecting curb lines of two streets)	25 feet

Roadway safety for both vehicular and pedestrian traffic is a key consideration for placement along public streets.

Underground utilities and overhead wires are considered in the design and avoided or circumvented. Underground utilities are routed around or through the planter in suspended pavement applications. All underground utilities are protected from water and root penetration.

Tree growth can damage utilities and overhead wires resulting in service interruptions. Protecting utilities routed through the planter prevents damage and service interruptions.

<i>Siting and Design</i>	<i>Intent/Rationale</i>
<p><input type="checkbox"/> Suspended pavement design was developed where appropriate to minimize soil compaction and improve infiltration and filtration capabilities.</p> <p>Suspended pavement was constructed with an approved structural cell.</p>	<p>Suspended pavement designs provide structural support without compaction of the underlying layers, thereby promoting tree growth.</p> <p>Recommended structural cells include poured in place concrete columns, Silva Cells manufactured by Deeproot Green Infrastructures and Stratacell and Stratavault systems manufactured by Citygreen Systems.</p>
<p><input type="checkbox"/> A minimum soil volume of 2 cubic feet per square foot of canopy projection volume is provided for each tree. Canopy projection area is the ground area beneath the tree, measured at the drip line.</p>	<p>The minimum soil volume ensures that there is adequate storage volume to allow for unrestricted evapotranspiration. A lower amount of soil volume may be allowed at the discretion of the [City Engineer] if certified by a landscape architect or agronomist. The retention credit from the tree is directly proportional to the soil volume provided for the tree.</p>
<p><input type="checkbox"/> DCV from the tributary area draining to the tree is equal to or greater than the tree credit volume</p>	<p>The minimum tributary area ensures that the tree receives enough runoff to fully utilize the infiltration and evapotranspiration potential provided. In cases where the minimum tributary area is not provided, the tree credit volume must be reduced proportionately to the actual tributary area.</p>
<p>Inlet opening to the tree that is at least 18 inches wide.</p> <p><input type="checkbox"/> A minimum 2 inch drop in grade from the inlet to the finish grade of the tree.</p> <p>Grated inlets are allowed for pedestrian circulation. Grates need to be ADA compliant and have sufficient slip resistance.</p>	<p>Design requirement to ensure that the runoff from the tributary area is not bypassed.</p> <p>Different inlet openings and drops in grade may be allowed at the discretion of the [City Engineer] if calculations are shown that the diversion flow rate (Appendix B.1.2) from the tributary area can be conveyed to the tree. In cases where the inlet capacity is limiting the amount of runoff draining to the tree,</p>

<i>Siting and Design</i>	<i>Intent/Rationale</i>
	the tree credit volume must be reduced proportionately.

Conceptual Design and Sizing Approach for Site Design

1. Determine the areas where street trees can be used in the site design to achieve incidental treatment. Street trees reduce runoff volumes from the site. Refer to Appendix B.2. Document the proposed tree locations in the SWQMP.
2. When trees are proposed as a storm water pollutant control BMP, applicant must complete feasibility analysis in Appendix C and D and submit detailed calculations for the DCV treated by trees. Document the proposed tree locations, feasibility analysis and sizing calculations in the SWQMP. The following calculations should be performed and the smallest of the three should be used as the volume treated by trees:
 - a. Delineate the DMA (tributary area) to the tree and calculate the associated DCV.
 - b. Calculate the required diversion flow rate using Appendix B.1.2 and size the inlet required to convey this flow rate to the tree. If the proposed inlet cannot convey the diversion flow rate for the entire tributary area, then the DCV that enters the tree should be proportionally reduced.
 - i. For example, 0.5 acre drains to the tree and the associated DCV is 820 ft³. The required diversion flow rate is 0.10 ft³/s, but only an inlet that can divert 0.05 ft³/s could be installed.
 - ii. Then the effective DCV draining to the tree = $820 \text{ ft}^3 * (0.05/0.10) = 420 \text{ ft}^3$
 - c. Estimate the amount of storm water treated by the tree by summing the following:
 - i. Evapotranspiration credit of 0.1 * amount of soil volume installed; and
 - ii. Infiltration credit calculated using sizing procedures in Appendix B.4.

E.3 SD-5 Impervious Area Dispersion



Photo Credit: Orange County Technical Guidance Document

MS4 Permit Category

Site Design

Manual Category

Site Design

Applicable Performance Criteria

Site Design

Primary Benefits

Volume Reduction

Peak Flow Attenuation

Description

Impervious area dispersion (dispersion) refers to the practice of effectively disconnecting impervious areas from directly draining to the storm drain system by routing runoff from impervious areas such as rooftops (through downspout disconnection), walkways, and driveways onto the surface of adjacent pervious areas. The intent is to slow runoff discharges, and reduce volumes. Dispersion with partial or full infiltration results in significant volume reduction by means of infiltration and evapotranspiration.

Typical dispersion components include:

- An impervious surface from which runoff flows will be routed with minimal piping to limit concentrated inflows
- Splash blocks, flow spreaders, or other means of dispersing concentrated flows and providing energy dissipation as needed
- Dedicated pervious area, typically vegetated, with in-situ soil infiltration capacity for partial or full infiltration
- Optional soil amendments to improve vegetation support, maintain infiltration rates and enhance treatment of routed flows
- Overflow route for excess flows to be conveyed from dispersion area to the storm drain system or discharge point

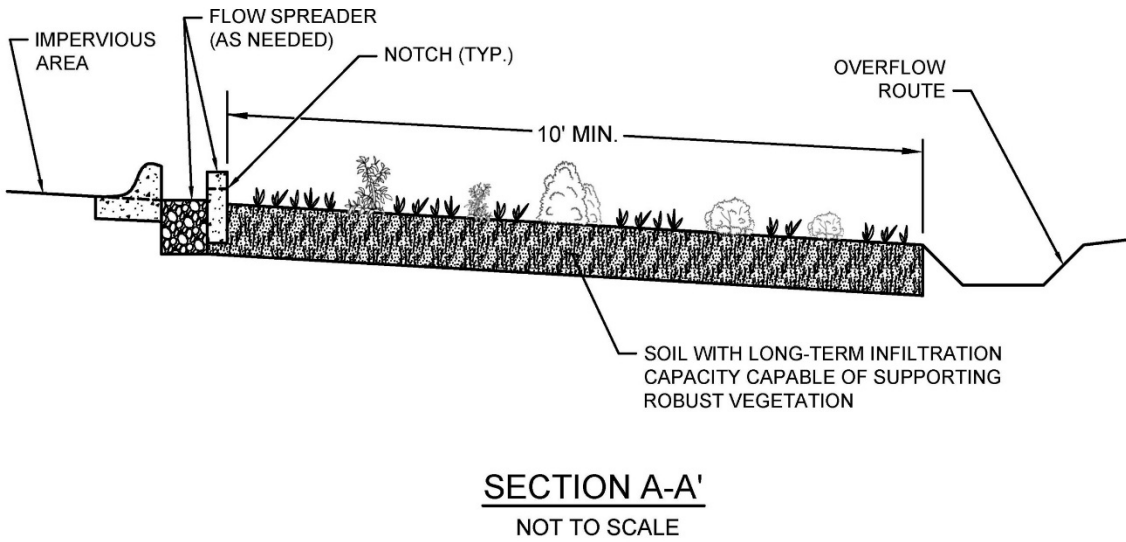
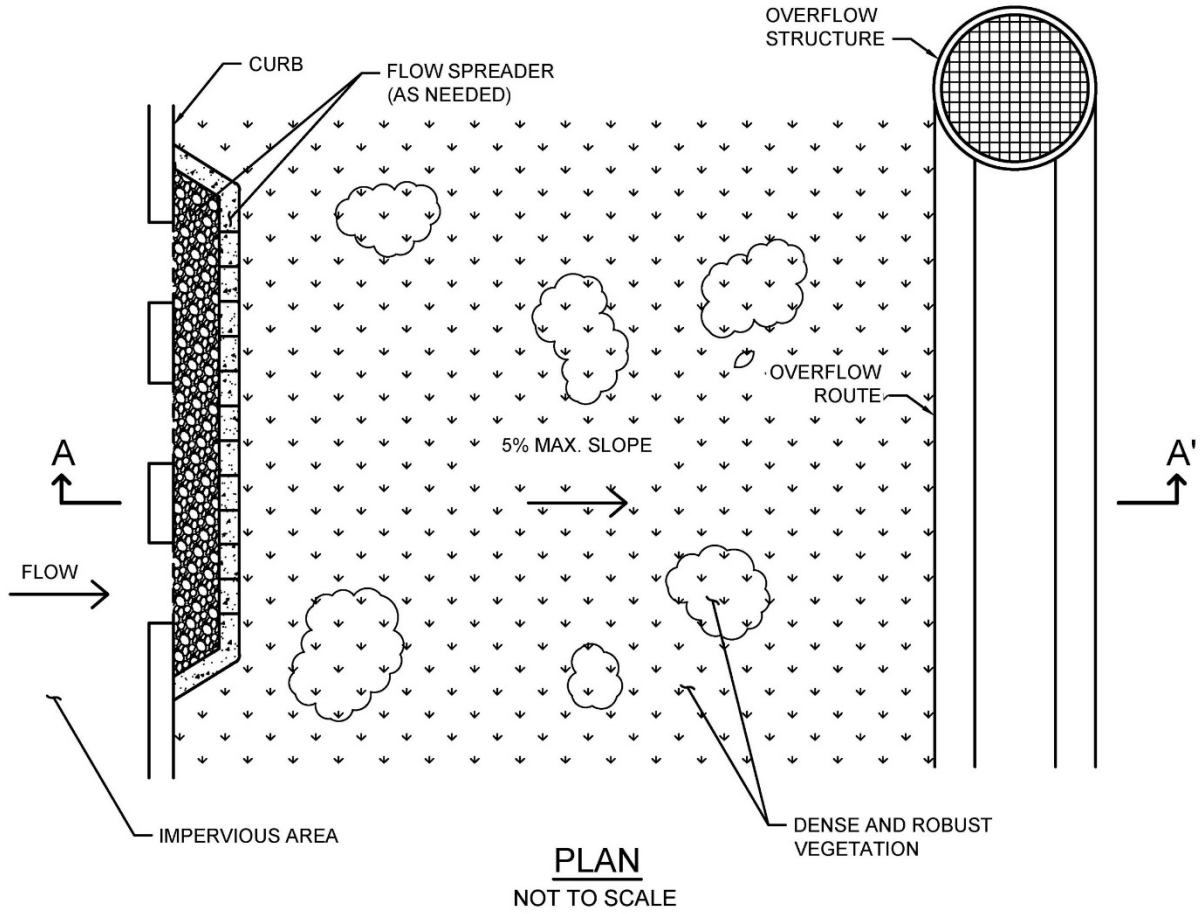

Typical plan and section view of an Impervious Area Dispersion BMP

Design Adaptations for Project Goals

Site design BMP to reduce impervious area and DCV. Impervious area dispersion primarily functions as a site design BMP for reducing the effective imperviousness of a site by providing partial or full infiltration of the flows that are routed to pervious dispersion areas and otherwise slowing down excess flows that eventually reach the storm drain system. This can significantly reduce the DCV for the site.

Design Criteria and Considerations

Dispersion must meet the following design criteria. Deviations from the below criteria may be approved at the discretion of the City Engineer if it is determined to be appropriate:

<i>Siting and Design</i>	<i>Intent/Rationale</i>
<input type="checkbox"/> Dispersion is over areas with soil types capable of supporting or being amended (e.g., with sand or compost) to support vegetation. Media amendments must be tested to verify that they are not a source of pollutants.	Soil must have long-term infiltration capacity for partial or full infiltration and be able to support vegetation to provide runoff treatment. Amendments to improve plant growth must not have negative impact on water quality.
<input type="checkbox"/> Dispersion has vegetated sheet flow over a relatively large distance (minimum 10 feet) from inflow to overflow route.	Full or partial infiltration requires relatively large areas to be effective depending on the permeability of the underlying soils.
<input type="checkbox"/> Pervious areas should be flat (with less than 5% slopes) and vegetated.	Flat slopes facilitate sheet flows and minimize velocities, thereby improving treatment and reducing the likelihood of erosion.
<i>Inflow velocities</i>	
<input type="checkbox"/> Inflow velocities are limited to 3 ft./s or less or use energy dissipation methods (e.g., riprap, level spreader) for concentrated inflows.	High inflow velocities can cause erosion, scour and/or channeling.
<i>Dedication</i>	
<input type="checkbox"/> Dispersion areas must be owned by the project owner and be dedicated for the purposes of dispersion to the exclusion of other future uses that might reduce the effectiveness of the dispersion area.	Dedicated dispersion areas prevent future conversion to alternate uses and facilitate continued full and partial infiltration benefits.

<i>Siting and Design</i>	<i>Intent/Rationale</i>
<i>Vegetation</i>	
<input type="checkbox"/> Dispersion typically requires dense and robust vegetation for proper function. Drought tolerant species should be selected to minimize irrigation needs. A plant list to aid in selection can be found in Appendix E.20.	Vegetation improves resistance to erosion and aids in runoff treatment.

Conceptual Design and Sizing Approach for Site Design

1. Determine the areas where dispersion can be used in the site design to reduce the DCV for pollutant control sizing.
2. Calculate the DCV for storm water pollutant control per Appendix B.2, taking into account reduced runoff from dispersion.
3. Determine if a DMA is considered “Self-retaining” if the impervious to pervious ratio is:
 - a. 2:1 when the pervious area is composed of Hydrologic Soil Group A
 - b. 1:1 when the pervious area is composed of Hydrologic Soil Group B

E.4 SD-6A: Green Roofs

MS4 Permit Category

Site Design

Manual Category

Site Design

Applicable Performance Standard

Site Design

Primary Benefits

Volume Reduction
Peak Flow Attenuation



Location: County of San Diego Operations Center, San Diego, California

Description

Green roofs are vegetated rooftop systems that reduce runoff volumes and rates, treat storm water pollutants through filtration and plant uptake, provide additional landscape amenity, and create wildlife habitat. Additionally, green roofs reduce the heat island effect and provide acoustical control, air filtration and oxygen production. In terms of building design, they can protect against ultraviolet rays and extend the roof lifetime, as well as increase the building insulation, thereby decreasing heating

and cooling costs. There are two primary types of green roofs:

- **Extensive** – lightweight, low maintenance system with low-profile, drought tolerant type groundcover in shallow growing medium (6 inches or less)
- **Intensive** – heavyweight, high maintenance system with a more garden-like configuration and diverse plantings that may include shrubs or trees in a thicker growing medium (greater than 6 inches)

Typical green roof components include, from top to bottom:

- Vegetation that is appropriate to the type of green roof system, climate, and watering conditions
- Media layer (planting mix or engineered media) capable of supporting vegetation growth
- Filter fabric to prevent migration of fines (soils) into the drainage layer
- Optional drainage layer to convey excess runoff
- Optional root barrier
- Optional insulation layer
- Waterproof membrane
- Structural roof support capable of withstanding the additional weight of a green roof

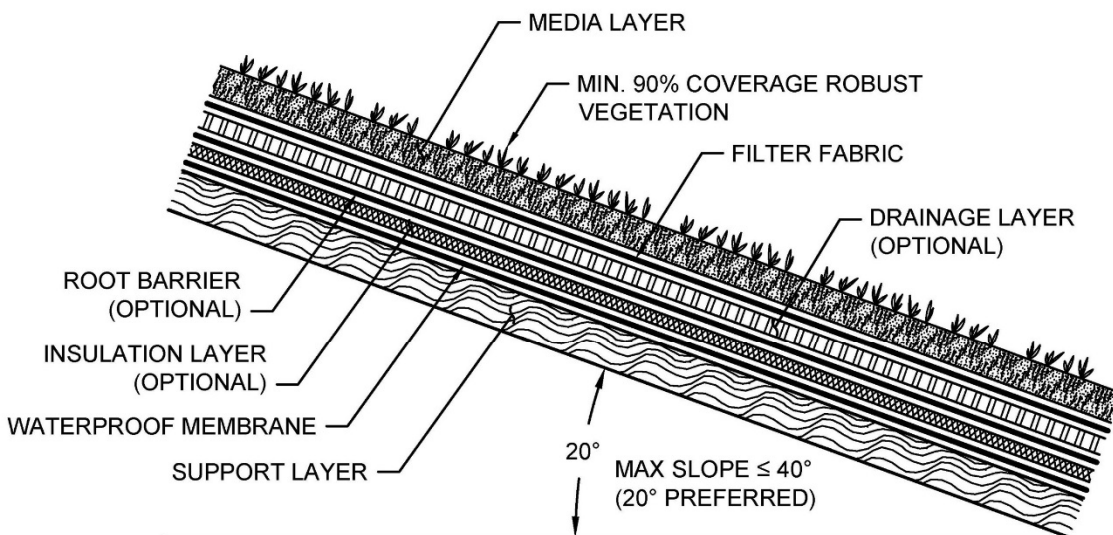

PROFILE
NOT TO SCALE

Typical profile of a Green Roof BMP

Design Adaptations for Project Goals

Site design BMP to provide incidental treatment. Green roofs can be used as a site design feature to reduce the impervious area of the site through replacing conventional roofing. This can reduce the DCV and flow control requirements for the site.

Design Criteria and Considerations

Green roofs must meet the following design criteria. Deviations from the below criteria may be approved at the discretion of the City Engineer if it is determined to be appropriate:

<i>Siting and Design</i>	<i>Intent/Rationale</i>
<input type="checkbox"/> Roof slope is $\leq 40\%$ (Roofs that are $\leq 20\%$ are preferred).	Steep roof slopes increases project complexity and requires supplemental anchoring.
<input type="checkbox"/> Structural roof capacity design supports the calculated additional load (lbs./sq. ft.) of the vegetation growing medium and additional drainage and barrier layers.	Inadequate structural capacity increases the risk for roof failure and harm to the building and occupants.
<input type="checkbox"/> Design and construction is planned to be completed by an experienced green roof specialist.	A green roof specialist will minimize complications in implementation and potential structural issues that are critical to green roof success.
<input type="checkbox"/> Green roof location and extent must meet fire safety provisions.	Green roof design must not negatively impact fire safety.
<input type="checkbox"/> Maintenance access is included in the green roof design.	Maintenance will facilitate proper functioning of drainage and irrigation components and allow for removal of undesirable vegetation and soil testing, as needed.
Vegetation	
<input type="checkbox"/> Vegetation is suitable for the green roof type, climate and expected watering conditions. Perennial, self-sowing plants that are drought-tolerant (e.g., sedums, succulents) and require little to no fertilizer, pesticides or herbicides are recommended. Vegetation pre-grown at grade may allow plants to establish prior to facing harsh roof conditions.	Plants suited to the design and expected growing environment are more likely to survive.

<i>Siting and Design</i>	<i>Intent/Rationale</i>
<input type="checkbox"/> Vegetation is capable of covering $\geq 90\%$ the roof surface.	Benefits of green roofs are greater with more surface vegetation.
<input type="checkbox"/> Vegetation is robust and erosion-resistant in order to withstand the anticipated rooftop environment (e.g., heat, cold, high winds).	Weak plants will not survive in extreme rooftop environments.
<input type="checkbox"/> Vegetation is fire resistant.	Vegetation that will not burn easily decreases the chance for fire and harm to the building and occupants.
<input type="checkbox"/> Vegetation considers roof sun exposure and shaded areas based on roof slope and location.	The amount of sunlight the vegetation receives can inhibit growth therefore the beneficial effects of a vegetated roof.
<input type="checkbox"/> An irrigation system (e.g., drip irrigation system) is included as necessary to maintain vegetation.	Proper watering will increase plant survival, especially for new plantings.
<input type="checkbox"/> Media is well-drained and is the appropriate depth required for the green roof type and vegetation supported.	Unnecessary water retention increases structural loading. An adequate media depth increases plant survival.
<input type="checkbox"/> A filter fabric is used to prevent migration of media fines through the system.	Migration of media can cause clogging of the drainage layer.
<input type="checkbox"/> A drainage layer is provided if needed to convey runoff safely from the roof. The drainage layer can be comprised of gravel, perforated sheeting, or other drainage materials.	Inadequate drainage increases structural loading and the risk of harm to the building and occupants.
<input type="checkbox"/> A root barrier comprised of dense material to inhibit root penetration is used if the waterproof membrane will not provide root penetration protection.	Root penetration can decrease the integrity of the underlying structural roof components and increase the risk of harm to the building and occupants.
<input type="checkbox"/> An insulation layer is included as needed to protect against the water in the drainage layer from extracting building heat in the winter and cool air in the summer.	Regulating thermal impacts of green roofs will aid in controlling building heating and cooling costs.
<input type="checkbox"/> A waterproof membrane is used to prevent the roof runoff from vertically	Water-damaged roof materials increase the risk of harm to the building and occupants.

Siting and Design

Intent/Rationale

migrating and damaging the roofing material. A root barrier may be required to prevent roots from compromising the integrity of the membrane.

Conceptual Design and Sizing Approach for Site Design

1. Determine the areas where green roofs can be used in the site design to replace conventional roofing to reduce the DCV. These green roof areas can be credited toward reducing runoff generated through representation in storm water calculations as pervious, not impervious, areas but are not credited for storm water pollutant control.
2. Calculate the DCV per Appendix B.2.

E.5 SD-6B Permeable Pavement (Site Design BMP)



Photo Credit: San Diego Low Impact Development Design Manual

Description

Permeable pavement is pavement that allows for percolation through void spaces in the pavement surface into subsurface layers. Permeable pavements reduce runoff volumes and rates and can provide pollutant control via infiltration, filtration, sorption, sedimentation, and biodegradation processes. When used as a site design BMP, the subsurface layers are designed to provide storage of storm water runoff so that outflow rates can be controlled via infiltration into subgrade soils. Varying levels of storm water treatment and

flow control can be provided depending on the size of the permeable pavement system relative to its drainage area and the underlying infiltration rates. As a site design BMP permeable pavement areas are designed to be self-retaining and are designed primarily for direct rainfall. Self-retaining permeable pavement areas have a ratio of total drainage area (including permeable pavement) to area of permeable pavement of 1.5:1 or less. Permeable pavement surfaces can be constructed from modular paver units or paver blocks, pervious concrete, porous asphalt, and turf pavers. Sites designed with permeable pavements can significantly reduce the impervious area of the project. Reduction in impervious surfaces decreases the DCV and can reduce the footprint of treatment control and flow control BMPs.

Design Adaptations for Project Goals

Site design BMP to reduce impervious area and DCV.

Permeable pavement without an underdrain can be used as a site design feature to reduce the impervious area of the site by replacing traditional pavements, including roadways, parking lots, emergency access lanes, sidewalks, trails and driveways.

Typical Permeable Pavement Components (Top to Bottom)

Permeable surface layer
Bedding layer for permeable surface
Aggregate storage layer with optional underdrain(s)
Optional final filter course layer over uncompacted existing subgrade

Conceptual Design and Sizing Approach for Site Design

1. Determine the areas where permeable pavements can be used in the site design to replace conventional pavements to reduce the DCV. These areas can be credited toward reducing runoff generated through representation in storm water calculations as pervious, not impervious, areas but are not credited for storm water pollutant control.
2. Calculate the DCV per Appendix B.2, taking into account reduced runoff from permeable pavement areas.

E.6 SD-8 Rain Barrels



Photo Credit: San Diego Low Impact Development Design Manual

Description

Rain barrels are containers that can capture rooftop runoff and store it for future use. With controlled timing and volume release, the captured rainwater can be used for irrigation or alternative grey water between storm events, thereby reducing runoff volumes and associated pollutants to downstream waterbodies. Rain barrels tend to be smaller systems, less than 100 gallons. Treatment can be achieved when rain barrels are used as part of a treatment train along with other BMPs that use captured flows in applications that do not result in discharges into the storm drain system. Rooftops are the ideal tributary areas for rain barrels.

Design Adaptations for Project Goals

Site design BMP to reduce effective impervious area and DCV. Barrels can be used as a site design feature to reduce the effective impervious area of the site by removing roof runoff from the site discharge. This can reduce the DCV and flow control requirements for the site.

Important Considerations

Maintenance: Rain barrels require regular monitoring and cleaning to ensure that they do not become clogged with leaves or other debris.

Economics: Rain barrels have low installation costs.

Limitations: Due to San Diego's arid climate, some rain barrels may fill only a few times each year.

Typical Rain Barrel Components

Storage container, barrel or tank for holding captured flows
Inlet and associated valves and piping
Outlet and associated valves and piping
Overflow outlet
Optional pump
Optional first flush diverters
Optional roof, supports, foundation, level indicator, and other accessories

Conceptual Design and Sizing Approach for Site Design

1. Determine the areas where rain barrels can be used in the site design to capture roof runoff to reduce the DCV. Rain barrels reduce the effective impervious area of the site by removing roof runoff from the site discharge.
2. Calculate the DCV per Appendix B.2, taking into account reduced runoff from permeable pavement areas.

E.7 HU-1 Cistern

MS4 Permit Category

Retention

Manual Category

Harvest and Use

Applicable Performance Standards

Pollutant Control

Flow Control

Primary Benefits

Volume Reduction

Peak Flow Attenuation



Photo Credit: Water Environment Research Foundation: WERF.org

Description

Cisterns are containers that can capture rooftop runoff and store it for future use. With controlled timing and volume release, the captured rainwater can be used for irrigation or alternative grey water between storm events, thereby reducing runoff volumes and associated pollutants to downstream water bodies. Cisterns are larger systems (generally >100 gallons) that can be self-contained aboveground or below ground systems. Treatment can be achieved when cisterns are used as part of a treatment train along with other BMPs that use captured flows in applications that do not result in discharges into the storm drain system. Rooftops are the ideal tributary areas for cisterns.

Typical cistern components include:

- Storage container, barrel or tank for holding captured flows
- Inlet and associated valves and piping
- Outlet and associated valves and piping
- Overflow outlet
- Optional pump
- Optional first flush diverters
- Optional roof, supports, foundation, level indicator, and other accessories

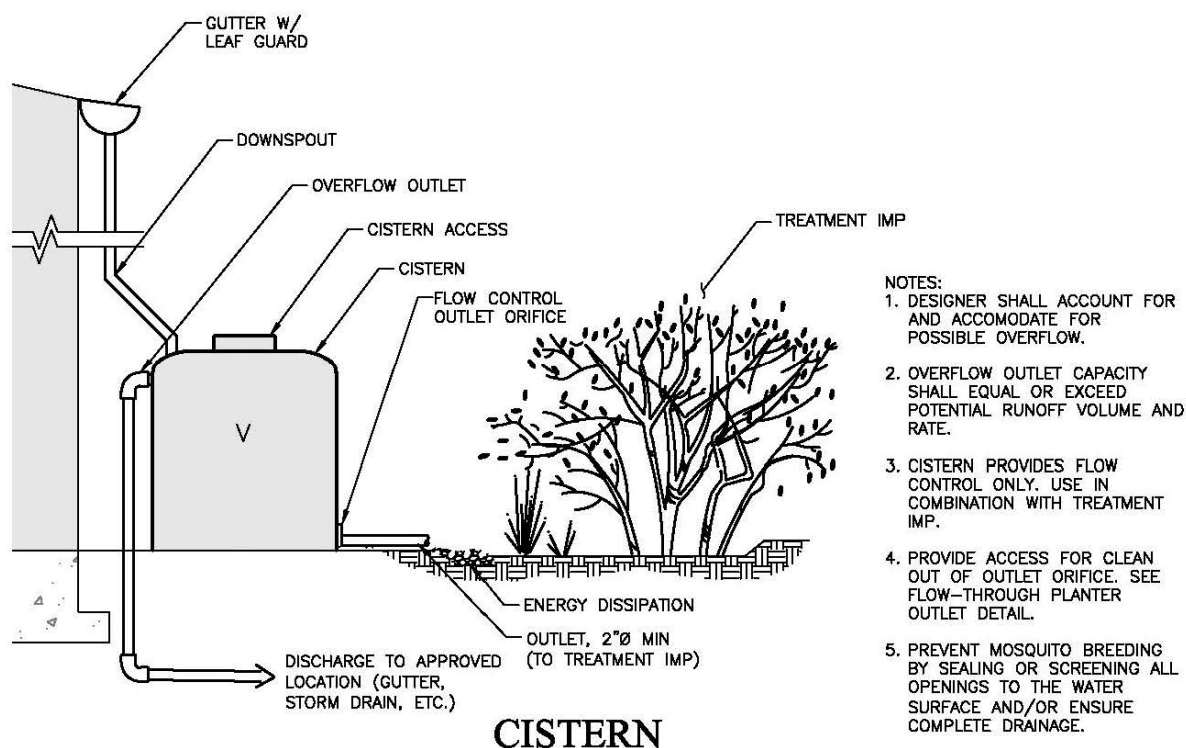

Source: City of San Diego Storm Water Standards

Design Adaptations for Project Goals

Site design BMP to reduce effective impervious area and DCV. Cisterns can be used as a site design feature to reduce the effective impervious area of the site by removing roof runoff from the site discharge. This can reduce the DCV and flow control requirements for the site.

Harvest and use for storm water pollutant control. Typical uses for captured flows include irrigation, toilet flushing, cooling system makeup, and vehicle and equipment washing.

Integrated storm water flow control and pollutant control configuration. Cisterns provide flow control in the form of volume reduction and/or peak flow attenuation and storm water treatment through elimination of discharges of pollutants. Additional flow control can be achieved by sizing the cistern to include additional detention storage and/or real-time automated flow release controls.

Design Criteria and Considerations

Cisterns must meet the following design criteria. Deviations from the below criteria may be approved

at the discretion of the City Engineer if it is determined to be appropriate:

<i>Siting and Design</i>	<i>Intent/Rationale</i>
<input type="checkbox"/> Cisterns are sized to detain the full DCV of contributing area and empty within 36 hours.	<p>Draining the cistern makes the storage volume available to capture the next storm.</p> <p>The applicant has an option to use a different drawdown time up to 96 hours if the volume of the facility is adjusted using the percent capture method in Appendix B.4.2.</p>
<input type="checkbox"/> Cisterns are fitted with a flow control device such as an orifice or a valve to limit outflow in accordance with drawdown time requirements.	<p>Flow control provides flow attenuation benefits and limits cistern discharge to downstream facilities during storm events.</p>
<input type="checkbox"/> Cisterns are designed to drain completely, leaving no standing water, and all entry points are fitted with traps or screens, or sealed.	<p>Complete drainage and restricted entry prevents mosquito habitat.</p>
<input type="checkbox"/> Leaf guards and/or screens are provided to prevent debris from accumulating in the cistern.	<p>Leaves and organic debris can clog the outlet of the cistern.</p>
<input type="checkbox"/> Access is provided for maintenance and the cistern outlets are accessible and designed to allow easy cleaning.	<p>Properly functioning outlets are needed to maintain proper flow control in accordance with drawdown time requirements.</p>
<input type="checkbox"/> Cisterns must be designed and sited such that overflow will be conveyed safely overland to the storm drain system or discharge point.	<p>Safe overflow conveyance prevents flooding and damage of property.</p>

Conceptual Design and Sizing Approach for Site Design and Storm Water Pollutant Control

1. Calculate the DCV for site design per Appendix B.
2. Determine the locations on the site where cisterns can be located to capture and detain the DCV from roof areas without subsequent discharge to the storm drain system. Cisterns are best located in close proximity to building and other roofed structures to minimize piping. Cisterns can also be used as part of a treatment train upstream by increasing pollutant control through delayed runoff to infiltration BMPs such as bioretention without underdrain facilities.
3. Use the sizing worksheet in Appendix B.3 to determine if full or partial capture of the DCV is achievable.

4. The remaining DCV to be treated should be calculated for use in sizing downstream BMP(s).

Conceptual Design and Sizing Approach when Storm Water Flow Control is Applicable

Control of flow rates and/or duration will typically require significant cistern volumes, and therefore the following steps should be taken prior to determination of site design and storm water pollutant control. Pre-development and allowable post-project flow rates and durations should be determined as discussed in Chapter 6 of the manual.

1. Verify that cistern siting and design criteria have been met. Design for flow control can be achieved using various design configurations, shapes, and quantities of cisterns.
2. Iteratively determine the cistern storage volume required to provide detention storage to reduce flow rates and durations to allowable limits. Flow rates and durations can be controlled from detention storage by altering outlet structure orifice size(s) and/or water control valve operation.
3. Verify that the cistern is drawdown within 36 hours. The drawdown time can be estimated by dividing the storage volume by the rate of use of harvested water.
4. If the cistern cannot fully provide the flow rate and duration control required by this manual, a downstream structure with additional storage volume or infiltration capacity such as a biofiltration can be used to provide remaining flow control.

E.8 INF-1 Infiltration Basin

MS4 Permit Category

Retention

Manual Category

Infiltration

Applicable Performance Standard

Pollutant Control

Flow Control

Primary Benefits

Volume Reduction

Peak Flow Attenuation



Photo Credit: <http://www.stormwaterpartners.com/facilities/basin.html>

Description

An infiltration basin typically consists of an earthen basin with a flat bottom constructed in naturally pervious soils. An infiltration basin retains storm water and allows it to evaporate and/or percolate into the underlying soils. The bottom of an infiltration basin is typically vegetated with native grasses or turf grass; however other types of vegetation can be used if they can survive periodic inundation

and long inter-event dry periods. Treatment is achieved primarily through infiltration, filtration, sedimentation, biochemical processes and plant uptake. Infiltration basins can be constructed as linear **trenches** or as **underground infiltration galleries**.

Typical infiltration basin components include:

- Inflow distribution mechanisms (e.g., perimeter flow spreader or filter strips)
- Energy dissipation mechanism for concentrated inflows (e.g., splash blocks or riprap)
- Forebay to provide pretreatment surface ponding for captured flows
- Vegetation selected based on basin use, climate, and ponding depth
- Uncompacted native soils at the bottom of the facility
- Overflow structure

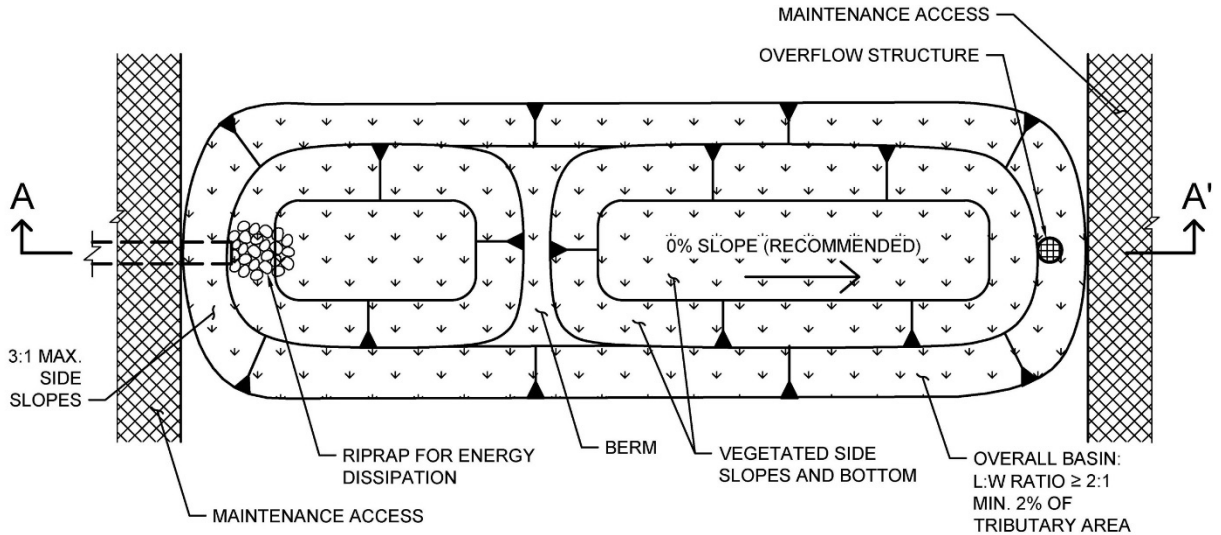

PLAN
NOT TO SCALE

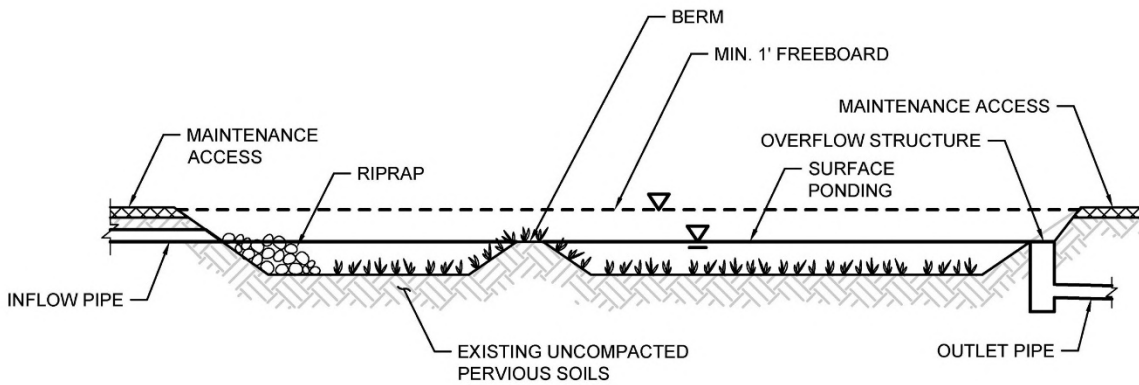

SECTION A-A'
NOT TO SCALE

Typical plan and section view of an Infiltration BMP

Design Adaptations for Project Goals

Full infiltration BMP for storm water pollutant control. Infiltration basins can be used as a pollutant control BMP, designed to infiltrate runoff from direct rainfall as well as runoff from adjacent areas that are tributary to the BMP. Infiltration basins must be designed with an infiltration storage volume (a function of the surface ponding volume) equal to the full DCV and able to meet drawdown time limitations.

Integrated storm water flow control and pollutant control configuration. Infiltration basins can

also be designed for flow rate and duration control by providing additional infiltration storage through increasing the surface ponding volume.

Design Criteria and Considerations

Infiltration basins must meet the following design criteria. Deviations from the below criteria may be approved at the discretion of the City Engineer if it is determined to be appropriate:

<i>Siting and Design</i>	<i>Intent/Rationale</i>
<input type="checkbox"/> Placement observes geotechnical recommendations regarding potential hazards (e.g., slope stability, landslides, and liquefaction zones) and setbacks (e.g., slopes, foundations, utilities).	Must not negatively impact existing site geotechnical concerns.
<input type="checkbox"/> Selection and design of basin is based on infiltration feasibility criteria and appropriate design infiltration rate (See Appendix C and D).	Must operate as a full infiltration design and must be supported by drainage area and in-situ infiltration rate feasibility findings.
<input type="checkbox"/> Finish grade of the facility is $\leq 2\%$ (0% recommended).	Flatter surfaces reduce erosion and channelization with the facility.
<input type="checkbox"/> Settling forebay has a volume $\geq 25\%$ of facility volume below the forebay overflow.	A forebay to trap sediment can decrease frequency of required maintenance.
<input type="checkbox"/> Infiltration of surface ponding is limited to a 36-hour drawdown time.	<p>Prolonged surface ponding reduce volume available to capture subsequent storms.</p> <p>The applicant has an option to use a different drawdown time up to 96 hours if the volume of the facility is adjusted using the percent capture method in Appendix B.4.2.</p>
<input type="checkbox"/> Minimum freeboard provided is ≥ 1 foot.	Freeboard minimizes risk of uncontrolled surface discharge.
<input type="checkbox"/> Side slopes are = 3H:1V or shallower.	Gentler side slopes are safer, less prone to erosion, able to establish vegetation more quickly and easier to maintain.

Inflow and Overflow Structures

<i>Siting and Design</i>	<i>Intent/Rationale</i>
<input type="checkbox"/> Inflow and outflow structures are accessible by required equipment (e.g., tractor truck) for inspection and maintenance.	Maintenance will prevent clogging and ensure proper operation of the flow control structures.
<input type="checkbox"/> Inflow velocities are limited to 3 ft./s or less or use energy dissipation methods (e.g., riprap, level spreader) for concentrated inflows.	High inflow velocities can cause erosion, scour and/or channeling.
<input type="checkbox"/> Overflow is safely conveyed to a downstream storm drain system or discharge point. Size overflow structure to pass 100-year peak flow for on-line basins and water quality peak flow for off-line basins.	Planning for overflow lessens the risk of property damage due to flooding.

Conceptual Design and Sizing Approach for Storm Water Pollutant Control

To design infiltration basins for storm water pollutant control only (no flow control required), the following steps should be taken:

1. Verify that siting and design criteria have been met, including placement and basin area requirements, forebay volume, and maximum slopes for basin sides and bottom.
2. Calculate the DCV per Appendix B based on expected site design runoff for tributary areas.
3. Use the sizing worksheet (Appendix B.4) to determine if full infiltration of the DCV is achievable based on the infiltration storage volume calculated from the surface ponding area and depth for a maximum 36-hour drawdown time. The drawdown time can be estimated by dividing the average depth of the basin by the design infiltration rate. Appendix D provides guidance on evaluating a site's infiltration rate.

Conceptual Design and Sizing Approach for Storm Water Pollutant Treatment and Flow Control

Control of flow rates and/or durations will typically require significant surface ponding volume, and therefore the following steps should be taken prior to determination of storm water pollutant control design. Pre-development and allowable post-project flow rates and durations should be determined as discussed in Chapter 6 of the manual.

1. Verify that siting and design criteria have been met, including placement and basin area requirements, forebay volume, and maximum slopes for basin sides and bottom.

Appendix E: BMP Design Fact Sheets

2. Iteratively determine the surface ponding required to provide infiltration storage to reduce flow rates and durations to allowable limits while adhering to the maximum 36-hour drawdown time. Flow rates and durations can be controlled using flow splitters that route the appropriate inflow amounts to the infiltration basin and bypass excess flows to the downstream storm drain system or discharge point.
3. If an infiltration basin cannot fully provide the flow rate and duration control required by this manual, an upstream or downstream structure with appropriate storage volume such as an underground vault can be used to provide additional control.
4. After the infiltration basin has been designed to meet flow control requirements, calculations must be completed to verify if storm water pollutant control requirements to treat the DCV have been met.

E.9 INF-2 Bioretention



MS4 Permit Category

Retention

Manual Category

Infiltration

Applicable Performance Standard

Pollutant Control
Flow Control

Primary Benefits

Volume Reduction
Treatment
Peak Flow Attenuation

Photo Credit: Ventura County Technical Guidance Document

Description

Bioretention (bioretention without underdrain) facilities are vegetated surface water systems that filter water through vegetation and soil, or engineered media prior to infiltrating into native soils. These facilities are designed to infiltrate the full DCV. Bioretention facilities are commonly incorporated into the site within parking lot landscaping, along roadsides, and in open spaces. They can be constructed in ground or partially aboveground, such as planter boxes with open bottoms (no impermeable liner at the bottom) to allow infiltration. Treatment is achieved through filtration, sedimentation, sorption, infiltration, biochemical processes and plant uptake.

Typical bioretention without underdrain components include:

- Inflow distribution mechanisms (e.g., perimeter flow spreader or filter strips)
- Energy dissipation mechanism for concentrated inflows (e.g., splash blocks or riprap)
- Shallow surface ponding for captured flows
- Side slope and basin bottom vegetation selected based on expected climate and ponding depth
- Non-floating mulch layer (optional)
- Media layer (planting mix or engineered media) capable of supporting vegetation growth
- Filter course layer consisting of aggregate to prevent the migration of fines into uncompacted

native soils or the optional aggregate storage layer

- Optional aggregate storage layer for additional infiltration storage
- Uncompacted native soils at the bottom of the facility
- Overflow structure

Design Adaptations for Project Goals

- **Full infiltration BMP for storm water pollutant control.** Bioretention can be used as a pollutant control BMP designed to infiltrate runoff from direct rainfall as well as runoff from adjacent tributary areas. Bioretention facilities must be designed with an infiltration storage volume (a function of the ponding, media and aggregate storage volumes) equal to the full DCV and able to meet drawdown time limitations.
- **Integrated storm water flow control and pollutant control configuration.** Bioretention facilities can be designed to provide flow rate and duration control. This may be accomplished by providing greater infiltration storage with increased surface ponding and/or aggregate storage volume for storm water flow control.

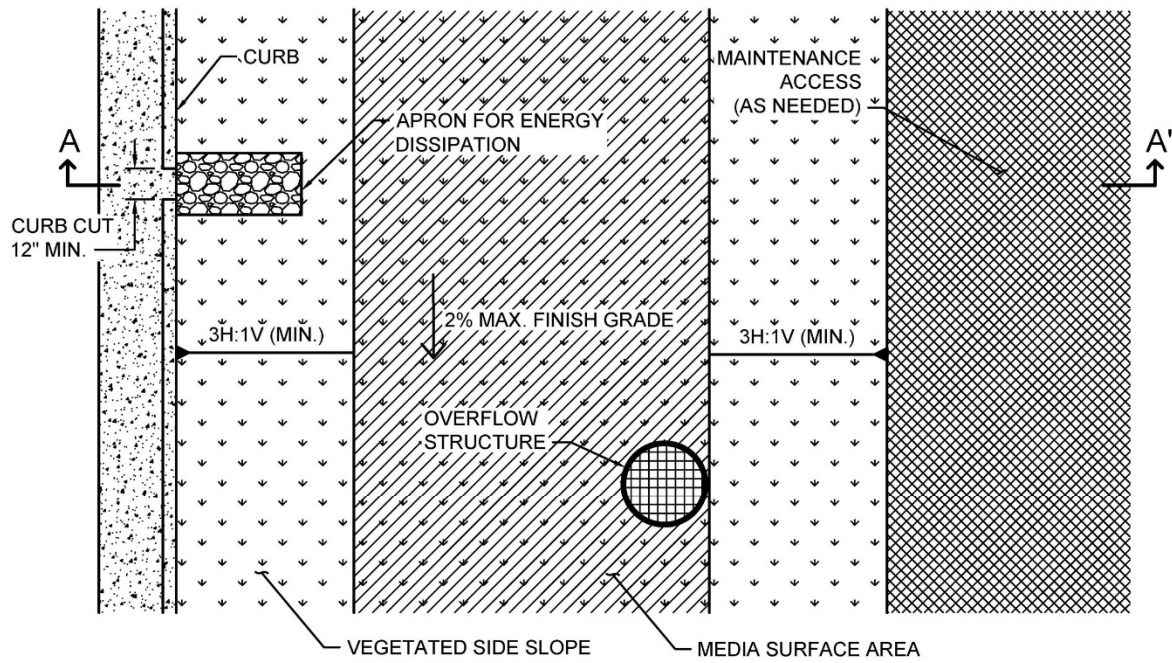

PLAN
NOT TO SCALE

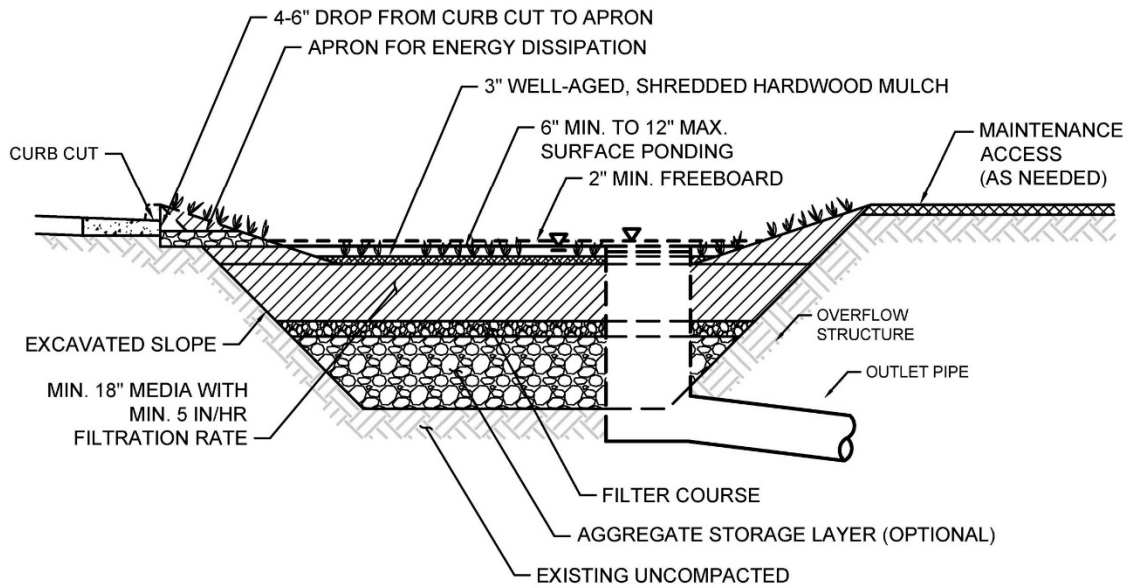

SECTION A-A'
NOT TO SCALE

Typical plan and section view of a Bioretention BMP

Design Criteria and Considerations

Bioretention must meet the following design criteria. Deviations from the below criteria may be approved at the discretion of the City Engineer if it is determined to be appropriate:

<i>Siting and Design</i>	<i>Intent/Rationale</i>
<input type="checkbox"/> Placement observes geotechnical recommendations regarding potential hazards (e.g., slope stability, landslides, and liquefaction zones) and setbacks (e.g., slopes, foundations, utilities).	Must not negatively impact existing site geotechnical concerns.
<input type="checkbox"/> Selection and design of BMP is based on infiltration feasibility criteria and appropriate design infiltration rate presented in Appendix C and D.	Must operate as a full infiltration design and must be supported by drainage area and in-situ infiltration rate feasibility findings.
<input type="checkbox"/> Contributing tributary area is ≤ 5 acres (≤ 1 acre preferred).	Bigger BMPs require additional design features for proper performance. Contributing tributary area greater than 5 acres may be allowed at the discretion of the [City Engineer] if the following conditions are met: 1) incorporate design features (e.g. flow spreaders) to minimizing short circuiting of flows in the BMP and 2) incorporate additional design features requested by the City Engineer for proper performance of the regional BMP.
<input type="checkbox"/> Finish grade of the facility is $\leq 2\%$. In long bioretention facilities where the potential for internal erosion and channelization exists, the use of check dams is required.	Flatter surfaces reduce erosion and channelization within the facility. Internal check dams reduce velocity and dissipate energy.
Surface Ponding	
<input type="checkbox"/> Surface ponding is limited to a 24-hour drawdown time.	24-hour drawdown time is recommended for plant health. Surface ponding drawdown time greater than 24-hours but less than 96 hours may be allowed at the discretion of the City Engineer if certified by a landscape architect or agronomist.

<i>Siting and Design</i>	<i>Intent/Rationale</i>
<input type="checkbox"/> Surface ponding depth is ≥ 6 and ≤ 12 inches.	<p>Surface ponding capacity lowers subsurface storage requirements. Deep surface ponding raises safety concerns.</p> <p>Surface ponding depth greater than 12 inches (for additional pollutant control or surface outlet structures or flow-control orifices) may be allowed at the discretion of the City Engineer if the following conditions are met: 1) surface ponding depth drawdown time is less than 24 hours; and 2) safety issues and fencing requirements are considered (typically ponding greater than 18" will require a fence and/or flatter side slopes) and 3) potential for elevated clogging risk is considered.</p>
<input type="checkbox"/> A minimum of 12 inches of freeboard is provided.	<p>Freeboard provides room for head over overflow structures and minimizes risk of uncontrolled surface discharge.</p>
<input type="checkbox"/> Side slopes are stabilized with vegetation and are $\geq 3H: 1V$.	<p>Gentler side slopes are safer, less prone to erosion, able to establish vegetation more quickly and easier to maintain.</p>
<i>Vegetation</i>	
<input type="checkbox"/> Plantings are suitable for the climate and expected ponding depth. A plant list to aid in selection can be found in Appendix E.20.	<p>Plants suited to the climate and ponding depth are more likely to survive.</p>
<input type="checkbox"/> An irrigation system with a connection to water supply is provided as needed.	<p>Seasonal irrigation might be needed to keep plants healthy.</p>
<i>Mulch</i>	
<input type="checkbox"/> A minimum of 3 inches of well-aged, shredded hardwood mulch that has been stockpiled or stored for at least 12 months is provided. Mulch must be non-floating to avoid clogging of overflow structure.	<p>Mulch will suppress weeds and maintain moisture for plant growth. Aging mulch kills pathogens and weed seeds and allows beneficial microbes to multiply.</p>
<i>Media Layer</i>	

<i>Siting and Design</i>	<i>Intent/Rationale</i>
<input type="checkbox"/> Media maintains a minimum filtration rate of 5 in/hr over lifetime of facility. A minimum initial filtration rate of 10 in/hr is recommended.	<p>A high filtration rate through the soil mix minimizes clogging potential and allows flows to quickly enter the aggregate storage layer, thereby minimizing bypass.</p>
<input type="checkbox"/> Media is a minimum 18 inches deep, meeting either of these two media specifications: City of San Diego Storm Water Standards, Appendix F (February 2016, unless superseded by more recent edition) or County of San Diego Low Impact Development Handbook: Appendix G -Bioretention Soil Specification (June 2014, unless superseded by more recent edition).	<p>A deep media layer provides additional filtration and supports plants with deeper roots.</p> <p>Standard specifications shall be followed.</p>
<input type="checkbox"/> Alternatively, for proprietary designs and custom media mixes not meeting the media specifications contained in the 2016 City or County LID Manual, the media meets the pollutant treatment performance criteria in Section F.1.	<p>For non-standard or proprietary designs, compliance with F.1 ensures that adequate treatment performance will be provided.</p>
<input type="checkbox"/> Media surface area is 3% of contributing area times adjusted runoff factor or greater, unless demonstrated that the BMP surface area can be smaller than 3%.	<p>Greater surface area to tributary area ratios decrease loading rates per square foot and therefore increase longevity.</p> <p>Adjusted runoff factor is to account for site design BMPs implemented upstream of the BMP (such as rain barrels, impervious area dispersion, etc.). Refer to Appendix B.2 guidance.</p> <p>Use Worksheet B.5-1 Line 26 to estimate the minimum surface area required per this criteria.</p>
<i>Filter Course Layer (Optional)</i>	
<input type="checkbox"/> A filter course is used to prevent migration of fines through layers of the facility. Filter fabric is not used.	<p>Migration of media can cause clogging of the aggregate storage layer void spaces or subgrade. Filter fabric is more likely to clog.</p>

<i>Siting and Design</i>	<i>Intent/Rationale</i>
<input type="checkbox"/> Filter course is washed and free of fines.	Washing aggregate will help eliminate fines that could clog the facility and impede infiltration.
<input type="checkbox"/> Filter course calculations assessing suitability for particle migration prevention have been completed.	Gradation relationship between layers can evaluate factors (e.g., bridging, permeability, and uniformity) to determine if particle sizing is appropriate or if an intermediate layer is needed.
<i>Aggregate Storage Layer (Optional)</i>	
<input type="checkbox"/> Class 2 Permeable per Caltrans specification 68-1.025 is recommended for the storage layer. Washed, open-graded crushed rock may be used, however a 4-6 inch washed pea gravel filter course layer at the top of the crushed rock is required.	Washing aggregate will help eliminate fines that could clog the aggregate storage layer void spaces or subgrade.
<input type="checkbox"/> Maximum aggregate storage layer depth is determined based on the infiltration storage volume that will infiltrate within a 36-hour drawdown time.	A maximum drawdown time to facilitate provision of adequate storm water storage for the next storm event.
<i>Inflow and Overflow Structures</i>	
<input type="checkbox"/> Inflow and overflow structures are accessible for inspection and maintenance. Overflow structures must be connected to downstream storm drain system or appropriate discharge point.	Maintenance will prevent clogging and ensure proper operation of the flow control structures.
<input type="checkbox"/> Inflow velocities are limited to 3 ft./s or less or use energy dissipation methods (e.g., riprap, level spreader) for concentrated inflows.	High inflow velocities can cause erosion, scour and/or channeling.
<input type="checkbox"/> Curb cut inlets are at least 12 inches wide, have a 4-6 inch reveal (drop) and an apron and energy dissipation as needed.	Inlets must not restrict flow and apron prevents blockage from vegetation as it grows in. Energy dissipation prevents erosion.
<input type="checkbox"/> Overflow is safely conveyed to a downstream storm drain system or discharge point. Size overflow structure to pass 100-year peak flow for on-line basins and water quality peak flow for off-line basins.	Planning for overflow lessens the risk of property damage due to flooding.

Conceptual Design and Sizing Approach for Storm Water Pollutant Control Only

To design bioretention for storm water pollutant control only (no flow control required), the following steps should be taken:

1. Verify that siting and design criteria have been met, including placement and basin area requirements, maximum side and finish grade slope, and the recommended media surface area tributary ratio.
2. Calculate the DCV per Appendix B based on expected site design runoff for tributary areas.
3. Use the sizing worksheet to determine if full infiltration of the DCV is achievable based on the available infiltration storage volume calculated from the bioretention without underdrain footprint area, effective depths for surface ponding, media and aggregate storage layers, and in-situ soil design infiltration rate for a maximum 36-hour drawdown time for the aggregate storage layer, with surface ponding no greater than a maximum 24-hour drawdown. The drawdown time can be estimated by dividing the average depth of the basin by the design infiltration rate of the underlying soil. Appendix D provides guidance on evaluating a site's infiltration rate. A generic sizing worksheet is provided in Appendix B.4.
4. Where the DCV cannot be fully infiltrated based on the site or bioretention constraints, an underdrain can be added to the design (use biofiltration with partial retention factsheet).

Conceptual Design and Sizing Approach when Storm Water Flow Control is Applicable

Control of flow rates and/or durations will typically require significant surface ponding and/or aggregate storage volumes, and therefore the following steps should be taken prior to determination of storm water pollutant control design. Pre-development and allowable post-project flow rates and durations shall be determined as discussed in Chapter 6 of the manual.

1. Verify that siting and design criteria have been met, including placement requirements, maximum side and finish grade slopes, and the recommended media surface area tributary area ratio. Design for flow control can be achieved using various design configurations.
2. Iteratively determine the facility footprint area, surface ponding and/or aggregate storage layer depth required to provide infiltration storage to reduce flow rates and durations to allowable limits while adhering to the maximum drawdown times for surface ponding and aggregate storage. Flow rates and durations can be controlled using flow splitters that route the appropriate inflow amounts to the bioretention facility and bypass excess flows to the downstream storm drain system or discharge point.
3. If bioretention without underdrain facility cannot fully provide the flow rate and duration control required by the MS4 permit, an upstream or downstream structure with appropriate storage volume such as an underground vault can be used to provide additional control.
4. After bioretention without underdrain BMPs have been designed to meet flow control requirements, calculations must be completed to verify if storm water pollutant control requirements to treat the DCV have been met.

E.10 INF-3 Permeable Pavement (Pollutant Control)



Location: Kellogg Park, San Diego, California

MS4 Permit Category

Retention
Flow-through Treatment
Control

Manual Category

Infiltration
Flow-through Treatment
Control

Applicable Performance Standard

Pollutant Control
Flow Control

Primary Benefits

Volume Reduction
Peak Flow Attenuation

Description

Permeable pavement is pavement that allows for percolation through void spaces in the pavement surface into subsurface layers. The subsurface layers are designed to provide storage of storm water runoff so that outflows, primarily via infiltration into subgrade soils or release to the downstream conveyance system, can be at controlled rates. Varying levels of storm water treatment and flow control can be provided depending on the size of the permeable pavement system relative to its drainage area, the underlying infiltration rates, and the configuration of outflow controls. Pollutant control permeable pavement is designed to receive runoff from a larger tributary area than site design permeable pavement (see SD-6B). Pollutant control is provided via infiltration, filtration, and sorption, sedimentation, and biodegradation processes.

Typical permeable pavement components include, from top to bottom:

- Permeable surface layer
- Bedding layer for permeable surface
- Aggregate storage layer with optional underdrain(s)
- Optional final filter course layer over uncompacted existing subgrade

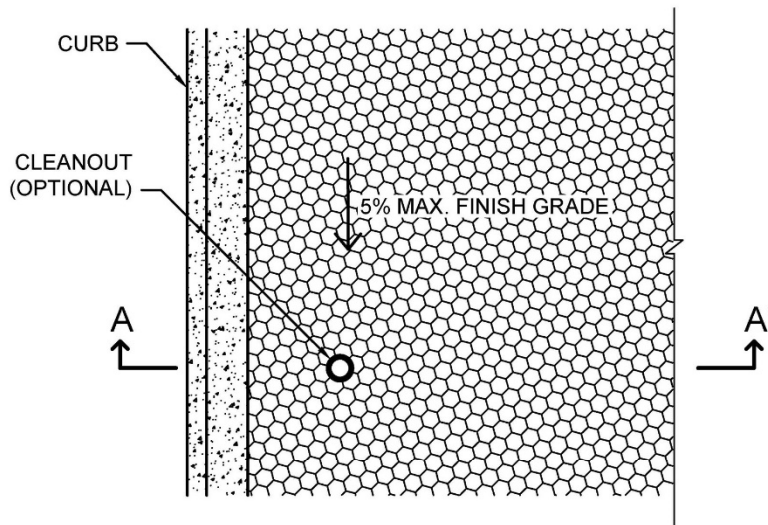

PLAN
NOT TO SCALE

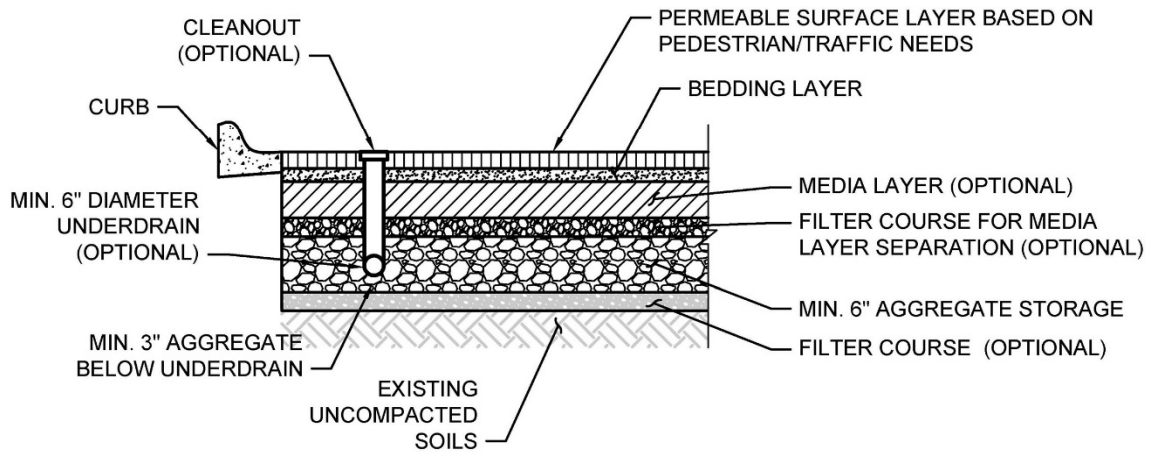

SECTION A-A'
NOT TO SCALE

Typical plan and Section view of a Permeable Pavement BMP

Subcategories of permeable pavement include modular paver units or paver blocks, pervious concrete,

porous asphalt, and turf pavers. These subcategory variations differ in the material used for the permeable surface layer but have similar functions and characteristics below this layer.

Design Adaptations for Project Goals

Site design BMP to reduce impervious area and DCV. See site design option SD-6B.

Full infiltration BMP for storm water pollutant control. Permeable pavement without an underdrain and without impermeable liners can be used as a pollutant control BMP, designed to infiltrate runoff from direct rainfall as well as runoff from adjacent areas that are tributary to the pavement. The system must be designed with an infiltration storage volume (a function of the aggregate storage volume) equal to the full DCV and able to meet drawdown time limitations.

Partial infiltration BMP with flow-through treatment for storm water pollutant control. Permeable pavement can be designed so that a portion of the DCV is infiltrated by providing an underdrain with infiltration storage below the underdrain invert. The infiltration storage depth should be determined by the volume that can be reliably infiltrated within drawdown time limitations. Water discharged through the underdrain is considered flow-through treatment and is not considered biofiltration treatment. Storage provided above the underdrain invert is included in the flow-through treatment volume.

Flow-through treatment BMP for storm water pollutant control. The system may be lined and/or installed over impermeable native soils with an underdrain provided at the bottom to carry away filtered runoff. Water quality treatment is provided via unit treatment processes other than infiltration. This configuration is considered to provide flow-through treatment, not biofiltration treatment. Significant aggregate storage provided above the underdrain invert can provide detention storage, which can be controlled via inclusion of an orifice in an outlet structure at the downstream end of the underdrain. **PDPs have the option to add saturated storage to the flow-through configuration in order to reduce the DCV that the BMP is required to treat.** Saturated storage can be added to this design by including an upturned elbow installed at the downstream end of the underdrain or via an internal weir structure designed to maintain a specific water level elevation. The DCV can be reduced by the amount of saturated storage provided.

Integrated storm water flow control and pollutant control configuration. With any of the above configurations, the system can be designed to provide flow rate and duration control. This may include having a deeper aggregate storage layer that allows for significant detention storage above the underdrain, which can be further controlled via inclusion of an outlet structure at the downstream end of the underdrain.

Design Criteria and Considerations

Permeable pavements must meet the following design criteria. Deviations from the below criteria may

be approved at the discretion of the City Engineer if it is determined to be appropriate:

<i>Siting and Design</i>	<i>Intent/Rationale</i>
<input type="checkbox"/> Placement observes geotechnical recommendations regarding potential hazards (e.g., slope stability, landslides, and liquefaction zones) and setbacks (e.g., slopes, foundations, utilities).	Must not negatively impact existing site geotechnical concerns.
<input type="checkbox"/> Selection must be based on infiltration feasibility criteria.	Full or partial infiltration designs must be supported by drainage area feasibility findings.
<input type="checkbox"/> An impermeable liner or other hydraulic restriction layer is included if site constraints indicate that infiltration should not be allowed.	Lining prevents storm water from impacting groundwater and/or sensitive environmental or geotechnical features. Incidental infiltration, when allowable, can aid in pollutant removal and groundwater recharge.
<input type="checkbox"/> Permeable pavement is not placed in an area with significant overhanging trees or other vegetation.	Leaves and organic debris can clog the pavement surface.
<input type="checkbox"/> For pollutant control permeable pavement, the ratio of the total drainage area (including the permeable pavement) to the permeable pavement should not exceed 4:1.	Higher ratios increase the potential for clogging but may be acceptable for relatively clean tributary areas.
<input type="checkbox"/> Finish grade of the permeable pavement has a slope $\leq 5\%$.	Flatter surfaces facilitate increased runoff capture.
<input type="checkbox"/> Minimum depth to groundwater and bedrock ≥ 10 ft.	A minimum separation facilitates infiltration and lessens the risk of negative groundwater impacts.
<input type="checkbox"/> Contributing tributary area includes effective sediment source control and/or pretreatment measures such as raised curbed or grass filter strips.	Sediment can clog the pavement surface.
<input type="checkbox"/> Direct discharges to permeable pavement are only from downspouts carrying “clean” roof runoff that are equipped with filters to remove gross solids.	Roof runoff typically carries less sediment than runoff from other impervious surfaces and is less likely to clog the pavement surface.

<i>Siting and Design</i>	<i>Intent/Rationale</i>
<i>Permeable Surface Layer</i>	
<input type="checkbox"/> Permeable surface layer type is appropriately chosen based on pavement use and expected vehicular loading.	Pavement may wear more quickly if not durable for expected loads or frequencies.
<input type="checkbox"/> Permeable surface layer type is appropriate for expected pedestrian traffic.	Expected demographic and accessibility needs (e.g., adults, children, seniors, runners, high-heeled shoes, wheelchairs, strollers, bikes) requires selection of appropriate surface layer type that will not impede pedestrian needs.
<i>Bedding Layer for Permeable Surface</i>	
<input type="checkbox"/> Bedding thickness and material is appropriate for the chosen permeable surface layer type.	<p>Porous asphalt requires a 2- to 4-inch layer of asphalt and a 1- to 2-inch layer of choker course (single-sized crushed aggregate, one-half inch) to stabilize the surface.</p> <p>Pervious concrete also requires an aggregate course of clean gravel or crushed stone with a minimum amount of fines.</p> <p>Permeable Interlocking Concrete Paver requires 1 or 2 inches of sand or No. 8 aggregate to allow for leveling of the paver blocks.</p> <p>Similar to Permeable Interlocking Concrete Paver, plastic grid systems also require a 1- to 2-inch bedding course of either gravel or sand.</p> <p>For Permeable Interlocking Concrete Paver and plastic grid systems, if sand is used, a geotextile should be used between the sand course and the reservoir media to prevent the sand from migrating into the stone media.</p>
<input type="checkbox"/> Aggregate used for bedding layer is washed prior to placement.	Washing aggregate will help eliminate fines that could clog the permeable

<i>Siting and Design</i>	<i>Intent/Rationale</i>
	pavement system aggregate storage layer void spaces or underdrain.
<i>Media Layer (Optional) –used between bedding layer and aggregate storage layer to provide pollutant treatment control</i>	
<input type="checkbox"/> The pollutant removal performance of the media layer is documented by the applicant.	Media used for BMP design should be shown via research or testing to be appropriate for expected pollutants of concern and flow rates.
<input type="checkbox"/> A filter course is provided to separate the media layer from the aggregate storage layer.	Migration of media can cause clogging of the aggregate storage layer void spaces or underdrain.
<input type="checkbox"/> If a filter course is used, calculations assessing suitability for particle migration prevention have been completed.	Gradation relationship between layers can evaluate factors (e.g., bridging, permeability, and uniformity) to determine if particle sizing is appropriate or if an intermediate layer is needed.
<input type="checkbox"/> Consult permeable pavement manufacturer to verify that media layer provides required structural support.	Media must not compromise the structural integrity or intended uses of the permeable pavement surface.
<i>Aggregate Storage Layer</i>	
<input type="checkbox"/> Aggregate used for the aggregate storage layer is washed and free of fines.	Washing aggregate will help eliminate fines that could clog aggregate storage layer void spaces or underdrain.
<input type="checkbox"/> Minimum layer depth is 6 inches and for infiltration designs, the maximum depth is determined based on the infiltration storage volume that will infiltrate within a 36-hour drawdown time.	A minimum depth of aggregate provides structural stability for expected pavement loads.
<i>Underdrain and Outflow Structures</i>	
<input type="checkbox"/> Underdrains and outflow structures, if used, are accessible for inspection and maintenance.	Maintenance will improve the performance and extend the life of the permeable pavement system.
<input type="checkbox"/> Underdrain outlet elevation should be a minimum of 3 inches above the bottom elevation of the aggregate storage layer.	A minimal separation from subgrade or the liner lessens the risk of fines entering the underdrain and can improve hydraulic performance by allowing perforations to remain unblocked.

<i>Siting and Design</i>		<i>Intent/Rationale</i>
<input type="checkbox"/>	Minimum underdrain diameter is 6 inches.	Smaller diameter underdrains are prone to clogging.
<input type="checkbox"/>	Underdrains are made of slotted, PVC pipe conforming to ASTM D 3034 or equivalent or corrugated, HDPE pipe conforming to AASHTO 252M or equivalent.	Slotted underdrains provide greater intake capacity, clog resistant drainage, and reduced entrance velocity into the pipe, thereby reducing the chances of solids migration.
<i>Filter Course (Optional)</i>		
<input type="checkbox"/>	Filter course is washed and free of fines.	Washing aggregate will help eliminate fines that could clog subgrade and impede infiltration.

Conceptual Design and Sizing Approach for Site Design

1. Determine the areas where permeable pavement can be used in the site design to replace traditional pavement to reduce the impervious area and DCV. These permeable pavement areas can be credited toward reducing runoff generated through representation in storm water calculations as pervious, not impervious, areas but are not credited for storm water pollutant control. These permeable pavement areas should be designed as self-retaining with the appropriate tributary area ratio identified in the design criteria.
2. Calculate the DCV per Appendix B, taking into account reduced runoff from self-retaining permeable pavement areas.

Conceptual Design and Sizing Approach for Storm Water Pollutant Control Only

To design permeable pavement for storm water pollutant control only (no flow control required), the following steps should be taken:

1. Verify that siting and design criteria have been met, including placement requirements, maximum finish grade slope, and the recommended tributary area ratio for non-self-retaining permeable pavement. If infiltration is infeasible, the permeable pavement can be designed as flow-through treatment per the sizing worksheet. If infiltration is feasible, calculations should follow the remaining design steps.
2. Calculate the DCV per Appendix B based on expected site design runoff for tributary areas.
3. Use the sizing worksheet to determine if full or partial infiltration of the DCV is achievable based on the available infiltration storage volume calculated from the permeable pavement footprint, aggregate storage layer depth, and in-situ soil design infiltration rate for a maximum 36-hour drawdown time. The applicant has an option to use a different drawdown time up to 96 hours if the volume of the facility is adjusted using the percent capture method in Appendix

B.4.2.

4. Where the DCV cannot be fully infiltrated based on the site or permeable pavement constraints, an underdrain must be incorporated above the infiltration storage to carry away runoff that exceeds the infiltration storage capacity.
5. The remaining DCV to be treated should be calculated for use in sizing downstream BMP(s).

Conceptual Design and Sizing Approach when Storm Water Flow Control is Applicable

Control of flow rates and/or durations will typically require significant aggregate storage volumes, and therefore the following steps should be taken prior to determination of storm water pollutant control design. Pre-development and allowable post-project flow rates and durations should be determined as discussed in Chapter 6 of the manual.

1. Verify that siting and design criteria have been met, including placement requirements, maximum finish grade slope, and the recommended tributary area ratio for non-self-retaining permeable pavement. Design for flow control can be achieved using various design configurations, but a flow-through treatment design will typically require a greater aggregate storage layer volume than designs which allow for full or partial infiltration of the DCV.
2. Iteratively determine the area and aggregate storage layer depth required to provide infiltration and/or detention storage to reduce flow rates and durations to allowable limits. Flow rates and durations can be controlled from detention storage by altering outlet structure orifice size(s) and/or water control levels. Multi-level orifices can be used within an outlet structure to control the full range of flows.
3. If the permeable pavement system cannot fully provide the flow rate and duration control required by this manual, a downstream structure with sufficient storage volume such as an underground vault can be used to provide remaining controls.
4. After permeable pavement has been designed to meet flow control requirements, calculations must be completed to verify if storm water pollutant control requirements to treat the DCV have been met.

E.11 PR-1 Biofiltration with Partial Retention



Location: 805 and Bonita Road, Chula vista, CA.

MS4 Permit Category

NA

Manual Category

Partial Retention

Applicable Performance Standard

Pollutant Control

Flow Control

Primary Benefits

Volume Reduction

Treatment

Peak Flow Attenuation

Description

Biofiltration with partial retention (partial infiltration and biofiltration) facilities are vegetated surface water systems that filter water through vegetation, and soil or engineered media prior to infiltrating into native soils, discharge via underdrain, or overflow to the downstream conveyance system. Where feasible, these BMPs have an elevated underdrain discharge point that creates storage capacity in the aggregate storage layer. Biofiltration with partial retention facilities are commonly incorporated into the site within parking lot landscaping, along roadsides, and in open spaces. They can be constructed in ground or partially aboveground, such as planter boxes with open bottoms to allow infiltration. Treatment is achieved through filtration, sedimentation, sorption, infiltration, biochemical processes and plant uptake.

Typical biofiltration with partial retention components include:

- Inflow distribution mechanisms (e.g., perimeter flow spreader or filter strips)
- Energy dissipation mechanism for concentrated inflows (e.g., splash blocks or riprap)
- Shallow surface ponding for captured flows
- Side Slope and basin bottom vegetation selected based on climate and ponding depth
- Non-floating mulch layer (Optional)
- Media layer (planting mix or engineered media) capable of supporting vegetation growth
- Filter course layer consisting of aggregate to prevent the migration of fines into uncompacted native soils or the optional aggregate storage layer
- Aggregate storage layer with underdrain(s)
- Uncompacted native soils at the bottom of the facility
- Overflow structure

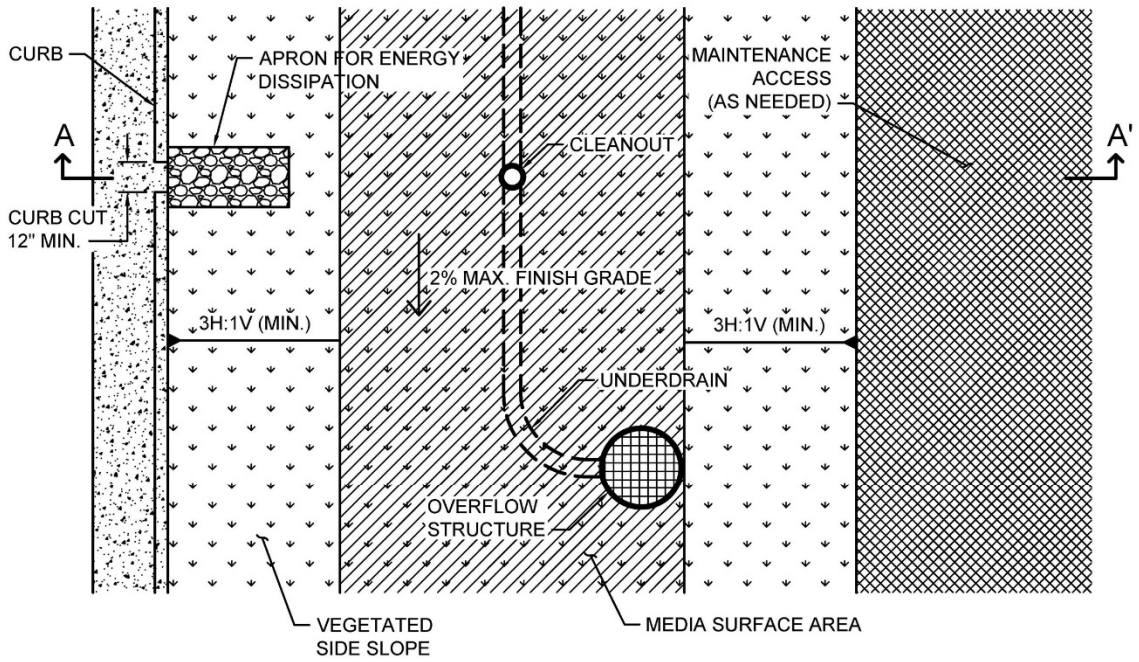

PLAN
NOT TO SCALE

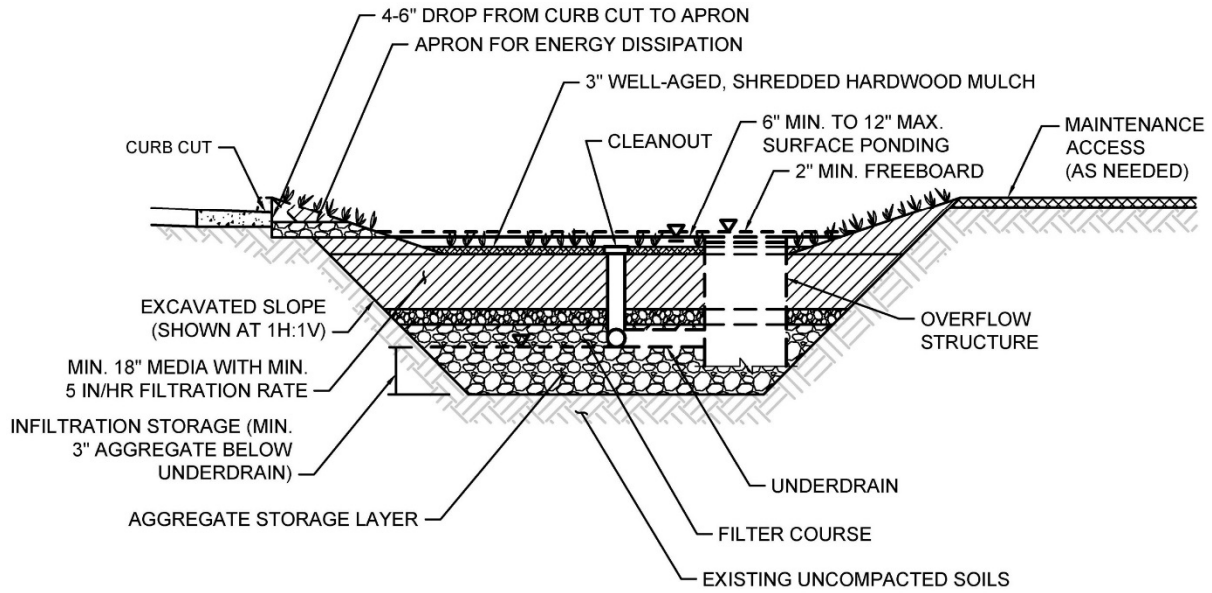

SECTION A-A'
NOT TO SCALE

Typical plan and Section view of a Biofiltration with Partial Retention BMP

Design Adaptations for Project Goals

Partial infiltration BMP with biofiltration treatment for storm water pollutant control.

Biofiltration with partial retention can be designed so that a portion of the DCV is infiltrated by providing infiltration storage below the underdrain invert. The infiltration storage depth should be determined by the volume that can be reliably infiltrated within drawdown time limitations. Water discharged through the underdrain is considered biofiltration treatment. Storage provided above the underdrain within surface ponding, media, and aggregate storage is included in the biofiltration treatment volume.

Integrated storm water flow control and pollutant control configuration. The system can be designed to provide flow rate and duration control by primarily providing increased surface ponding and/or having a deeper aggregate storage layer. This will allow for significant detention storage, which can be controlled via inclusion of an orifice in an outlet structure at the downstream end of the underdrain.

Design Criteria and Considerations

Biofiltration with partial retention must meet the following design criteria and considerations. Deviations from the below criteria may be approved at the discretion of the City Engineer if it is determined to be appropriate:

<i>Siting and Design</i>	<i>Intent/Rationale</i>
<input type="checkbox"/> Placement observes geotechnical recommendations regarding potential hazards (e.g., slope stability, landslides, and liquefaction zones) and setbacks (e.g., slopes, foundations, utilities).	Must not negatively impact existing site geotechnical concerns.
<input type="checkbox"/> Selection and design of basin is based on infiltration feasibility criteria and appropriate design infiltration rate (See Appendix C and D).	Must operate as a partial infiltration design and must be supported by drainage area and in-situ infiltration rate feasibility findings.
<input type="checkbox"/> Contributing tributary area shall be ≤ 5 acres (≤ 1 acre preferred).	Bigger BMPs require additional design features for proper performance. Contributing tributary area greater than 5 acres may be allowed at the discretion of the [City Engineer} if the following conditions are met: 1) incorporate design features (e.g. flow spreaders) to minimizing short circuiting of flows in the BMP and 2) incorporate additional

<i>Siting and Design</i>	<i>Intent/Rationale</i>
	design features requested by the City Engineer for proper performance of the regional BMP.
<input type="checkbox"/> Finish grade of the facility is $\leq 2\%$.	Flatter surfaces reduce erosion and channelization within the facility.
<i>Surface Ponding</i>	
<input type="checkbox"/> Surface ponding is limited to a 24-hour drawdown time.	Surface ponding limited to 24 hours for plant health. Surface ponding drawdown time greater than 24-hours but less than 96 hours may be allowed at the discretion of the City Engineer if certified by a landscape architect or agronomist.
<input type="checkbox"/> Surface ponding depth is ≥ 6 and ≤ 12 inches.	Surface ponding capacity lowers subsurface storage requirements. Deep surface ponding raises safety concerns. Surface ponding depth greater than 12 inches (for additional pollutant control or surface outlet structures or flow-control orifices) may be allowed at the discretion of the City Engineer if the following conditions are met: 1) surface ponding depth drawdown time is less than 24 hours; and 2) safety issues and fencing requirements are considered (typically ponding greater than 18" will require a fence and/or flatter side slopes) and 3) potential for elevated clogging risk is considered.
<input type="checkbox"/> A minimum of 12 inches of freeboard is provided.	Freeboard provides room for head over overflow structures and minimizes risk of uncontrolled surface discharge.
<input type="checkbox"/> Side slopes are stabilized with vegetation and are = 3H:1V or shallower.	Gentler side slopes are safer, less prone to erosion, able to establish vegetation more quickly and easier to maintain.
<i>Vegetation</i>	

<i>Siting and Design</i>	<i>Intent/Rationale</i>
<input type="checkbox"/> Plantings are suitable for the climate and expected ponding depth. A plant list to aid in selection can be found in Appendix E.20	Plants suited to the climate and ponding depth are more likely to survive.
<input type="checkbox"/> An irrigation system with a connection to water supply should be provided as needed.	Seasonal irrigation might be needed to keep plants healthy.
<i>Mulch</i>	
<input type="checkbox"/> A minimum of 3 inches of well-aged, shredded hardwood mulch that has been stockpiled or stored for at least 12 months is provided. Mulch must be non-floating to avoid clogging of overflow structure.	Mulch will suppress weeds and maintain moisture for plant growth. Aging mulch kills pathogens and weed seeds and allows the beneficial microbes to multiply.
<i>Media Layer</i>	
<input type="checkbox"/> Media maintains a minimum filtration rate of 5 in/hr over lifetime of facility. An initial filtration rate of 8 to 12 in/hr is recommended to allow for clogging over time; the initial filtration rate should not exceed 12 inches per hour.	A filtration rate of at least 5 inches per hour allows soil to drain between events, and allows flows to relatively quickly enter the aggregate storage layer, thereby minimizing bypass. The initial rate should be higher than long term target rate to account for clogging over time. However an excessively high initial rate can have a negative impact on treatment performance, therefore an upper limit is needed.
<input type="checkbox"/> Media is a minimum 18 inches deep, meeting either of these two media specifications: Storm Water Standards Appendix F (February 2016, unless superseded by more recent edition) or County of San Diego Low Impact Development Handbook: Appendix G - Bioretention Soil Specification (June 2014, unless superseded by more recent edition).	A deep media layer provides additional filtration and supports plants with deeper roots. Standard specifications shall be followed.
<input type="checkbox"/> Alternatively, for proprietary designs and custom media mixes not meeting the media specifications contained in the 2016 City or County LID Manual, the media meets the pollutant treatment performance criteria in	For non-standard or proprietary designs, compliance with Appendix F.1 ensures that adequate treatment performance will be provided.

<i>Siting and Design</i>	<i>Intent/Rationale</i>
filter course layer at the top of the crushed rock is required.	
<input type="checkbox"/> Maximum aggregate storage layer depth below the underdrain invert is determined based on the infiltration storage volume that will infiltrate within a 36-hour drawdown time.	A maximum drawdown time is needed for vector control and to facilitate providing storm water storage for the next storm event.
<i>Inflow, Underdrain, and Outflow Structures</i>	
<input type="checkbox"/> Inflow, underdrains and outflow structures are accessible for inspection and maintenance.	Maintenance will prevent clogging and ensure proper operation of the flow control structures.
<input type="checkbox"/> Inflow velocities are limited to 3 ft./s or less or use energy dissipation methods. (e.g., riprap, level spreader) for concentrated inflows.	High inflow velocities can cause erosion, scour and/or channeling.
<input type="checkbox"/> Curb cut inlets are at least 12 inches wide, have a 4-6 inch reveal (drop) and an apron and energy dissipation as needed.	Inlets must not restrict flow and apron prevents blockage from vegetation as it grows in. Energy dissipation prevents erosion.
<input type="checkbox"/> Underdrain outlet elevation should be a minimum of 3 inches above the bottom elevation of the aggregate storage layer.	A minimal separation from subgrade or the liner lessens the risk of fines entering the underdrain and can improve hydraulic performance by allowing perforations to remain unblocked.
<input type="checkbox"/> Minimum underdrain diameter is 6 inches.	Smaller diameter underdrains are prone to clogging.
<input type="checkbox"/> Underdrains are made of slotted, PVC pipe conforming to ASTM D 3034 or equivalent or corrugated, HDPE pipe conforming to AASHTO 252M or equivalent.	Slotted underdrains provide greater intake capacity, clog resistant drainage, and reduced entrance velocity into the pipe, thereby reducing the chances of solids migration.
<input type="checkbox"/> An underdrain cleanout with a minimum 6-inch diameter and lockable cap is placed every 250 to 300 feet as required based on underdrain length.	Properly spaced cleanouts will facilitate underdrain maintenance.
<input type="checkbox"/> Overflow is safely conveyed to a downstream storm drain system or discharge point. Size overflow structure to pass 100-year peak flow	Planning for overflow lessens the risk of property damage due to flooding.

<i>Siting and Design</i>	<i>Intent/Rationale</i>
for on-line infiltration basins and water quality peak flow for off-line basins.	

Nutrient Sensitive Media Design

To design biofiltration with partial retention with underdrain for storm water pollutant control only (no flow control required), the following steps should be taken:

Conceptual Design and Sizing Approach for Storm Water Pollutant Control Only

To design biofiltration with partial retention and an underdrain for storm water pollutant control only (no flow control required), the following steps should be taken:

1. Verify that siting and design criteria have been met, including placement requirements, contributing tributary area, maximum side and finish grade slopes, and the recommended media surface area tributary ratio.
2. Calculate the DCV per Appendix B based on expected site design runoff for tributary areas.
3. Generalized sizing procedure is presented in Appendix B.5. The surface ponding should be verified to have a maximum 24-hour drawdown time.

Conceptual Design and Sizing Approach when Storm Water Flow Control is Applicable

Control of flow rates and/or durations will typically require significant surface ponding and/or aggregate storage volumes, and therefore the following steps should be taken prior to determination of storm water pollutant control design. Pre-development and allowable post-project flow rates and durations should be determined as discussed in Chapter 6 of the manual.

1. Verify that siting and design criteria have been met, including placement requirements, contributing tributary area, maximum side and finish grade slopes, and the recommended media surface area tributary ratio.
2. Iteratively determine the facility footprint area, surface ponding and/or aggregate storage layer depth required to provide detention and/or infiltration storage to reduce flow rates and durations to allowable limits. Flow rates and durations can be controlled from detention storage by altering outlet structure orifice size(s) and/or water control levels. Multi-level orifices can be used within an outlet structure to control the full range of flows.
3. If biofiltration with partial retention cannot fully provide the flow rate and duration control required by this manual, an upstream or downstream structure with significant storage volume such as an underground vault can be used to provide remaining controls.
4. After biofiltration with partial retention has been designed to meet flow control requirements, calculations must be completed to verify if storm water pollutant control requirements to treat the DCV have been met.

E.12 BF-1 Biofiltration



Location: 43rd Street and Logan Avenue, San Diego, California

Description

Biofiltration (Bioretention with underdrain) facilities are vegetated surface water systems that filter water through vegetation, and soil or engineered media prior to discharge via underdrain or overflow to the downstream conveyance system. Bioretention with underdrain facilities are commonly incorporated into the site within parking lot landscaping, along roadsides, and in open spaces. Because these types of facilities have limited or no infiltration, they are typically designed to provide enough hydraulic head to move flows through the underdrain connection to the storm drain system. Treatment is achieved through filtration, sedimentation, sorption, biochemical processes and plant uptake.

Typical bioretention with underdrain components include:

- Inflow distribution mechanisms (e.g., perimeter flow spreader or filter strips)
- Energy dissipation mechanism for concentrated inflows (e.g., splash blocks or riprap)
- Shallow surface ponding for captured flows
- Side slope and basin bottom vegetation selected based on expected climate and ponding depth
- Non-floating mulch layer (Optional)
- Media layer (planting mix or engineered media) capable of supporting vegetation growth
- Filter course layer consisting of aggregate to prevent the migration of fines into uncompacted native soils or the aggregate storage layer
- Aggregate storage layer with underdrain(s)
- Impermeable liner or uncompacted native soils at the bottom of the facility
- Overflow structure

MS4 Permit Category

Biofiltration

Manual Category

Biofiltration

Applicable Performance Standard

Pollutant Control

Flow Control

Primary Benefits

Treatment

Volume Reduction (Incidental)

Peak Flow Attenuation (Optional)

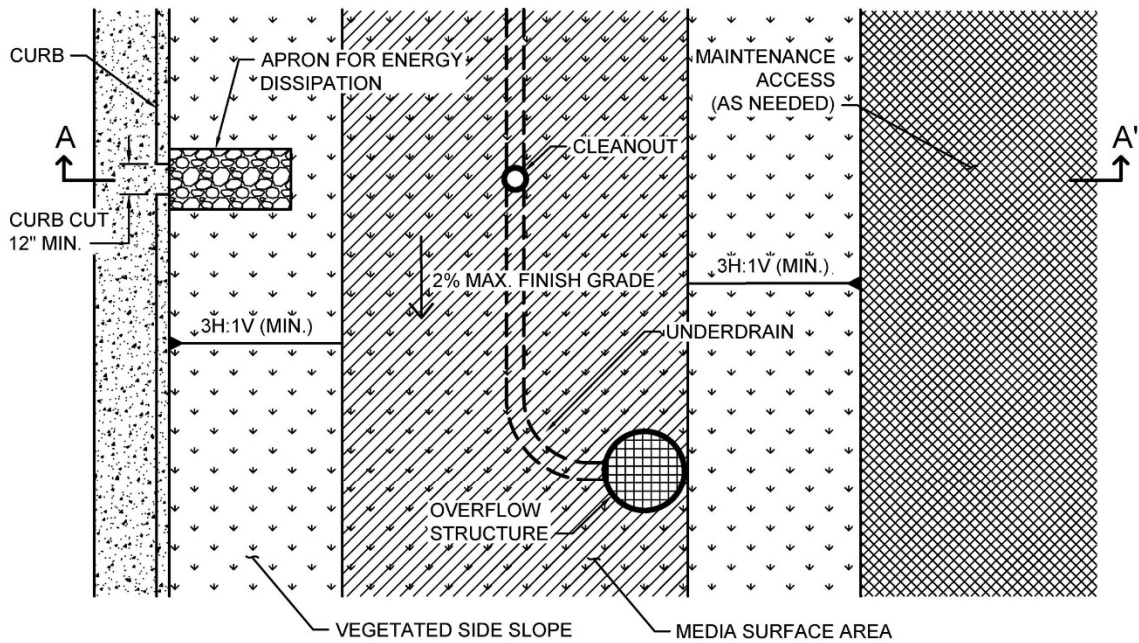

PLAN
NOT TO SCALE

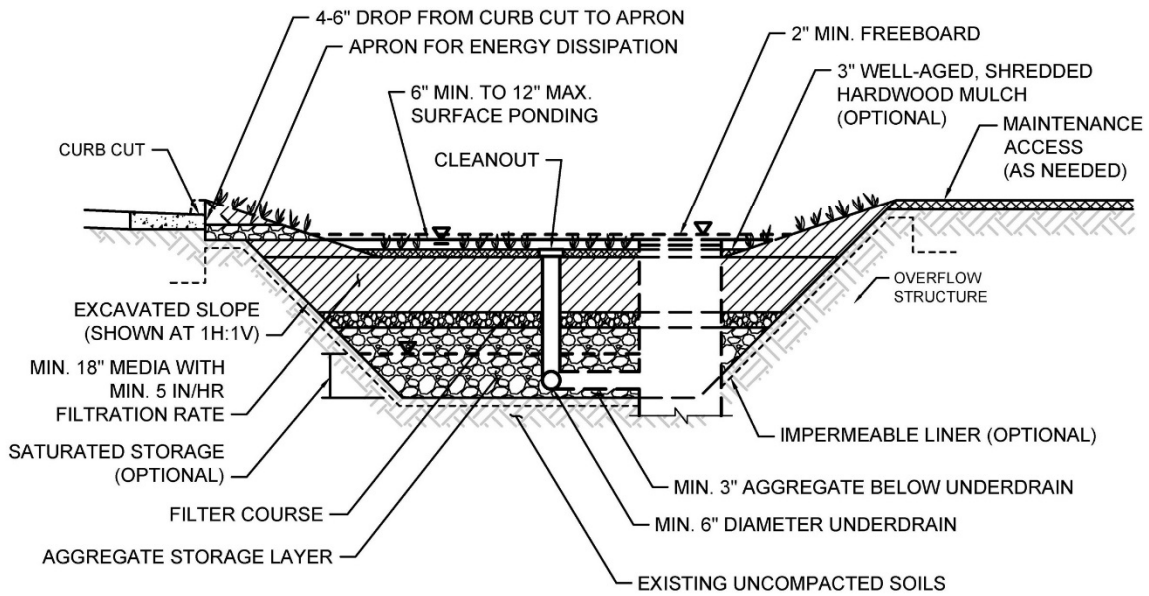

SECTION A-A'
NOT TO SCALE

Typical plan and Section view of a Biofiltration BMP

Design Adaptations for Project Goals

Biofiltration Treatment BMP for storm water pollutant control. The system is lined or un-lined to provide incidental infiltration, and an underdrain is provided at the bottom to carry away filtered runoff. This configuration is considered to provide biofiltration treatment via flow through the media layer. Storage provided above the underdrain within surface ponding, media, and aggregate storage is considered included in the biofiltration treatment volume. Saturated storage within the aggregate storage layer can be added to this design by raising the underdrain above the bottom of the aggregate storage layer or via an internal weir structure designed to maintain a specific water level elevation.

Integrated storm water flow control and pollutant control configuration. The system can be designed to provide flow rate and duration control by primarily providing increased surface ponding and/or having a deeper aggregate storage layer above the underdrain. This will allow for significant detention storage, which can be controlled via inclusion of an outlet structure at the downstream end of the underdrain.

Design Criteria and Considerations

Bioretention with underdrain must meet the following design criteria. Deviations from the below criteria may be approved at the discretion of the City Engineer if it is determined to be appropriate:

<i>Siting and Design</i>	<i>Intent/Rationale</i>
<input type="checkbox"/> Placement observes geotechnical recommendations regarding potential hazards (e.g., slope stability, landslides, and liquefaction zones) and setbacks (e.g., slopes, foundations, utilities).	Must not negatively impact existing site geotechnical concerns.
<input type="checkbox"/> An impermeable liner or other hydraulic restriction layer is included if site constraints indicate that infiltration or lateral flows should not be allowed.	Lining prevents storm water from impacting groundwater and/or sensitive environmental or geotechnical features. Incidental infiltration, when allowable, can aid in pollutant removal and groundwater recharge.
<input type="checkbox"/> Contributing tributary area shall be ≤ 5 acres (≤ 1 acre preferred).	Bigger BMPs require additional design features for proper performance. Contributing tributary area greater than 5 acres may be allowed at the discretion of the City Engineer if the following conditions are met: 1) incorporate design features (e.g. flow spreaders) to minimizing short circuiting of flows in

<i>Siting and Design</i>	<i>Intent/Rationale</i>
	the BMP and 2) incorporate additional design features requested by the City Engineer for proper performance of the regional BMP.
<input type="checkbox"/> Finish grade of the facility is $\leq 2\%$.	Flatter surfaces reduce erosion and channelization within the facility.
<i>Surface Ponding</i>	
<input type="checkbox"/> Surface ponding is limited to a 24-hour drawdown time.	Surface ponding limited to 24 hour for plant health. Surface ponding drawdown time greater than 24-hours but less than 96 hours may be allowed at the discretion of the City Engineer if certified by a landscape architect or agronomist.
<input type="checkbox"/> Surface ponding depth is ≥ 6 and ≤ 12 inches.	Surface ponding capacity lowers subsurface storage requirements. Deep surface ponding raises safety concerns. Surface ponding depth greater than 12 inches (for additional pollutant control or surface outlet structures or flow-control orifices) may be allowed at the discretion of the City Engineer if the following conditions are met: 1) surface ponding depth drawdown time is less than 24 hours; and 2) safety issues and fencing requirements are considered (typically ponding greater than 18" will require a fence and/or flatter side slopes) and 3) potential for elevated clogging risk is considered.
<input type="checkbox"/> A minimum of 2 inches of freeboard is provided.	Freeboard provides room for head over overflow structures and minimizes risk of uncontrolled surface discharge.
<input type="checkbox"/> Side slopes are stabilized with vegetation and are = 3H:1V or shallower.	Gentler side slopes are safer, less prone to erosion, able to establish vegetation more quickly and easier to maintain.
<i>Vegetation</i>	

<i>Siting and Design</i>	<i>Intent/Rationale</i>
<input type="checkbox"/> Plantings are suitable for the climate and expected ponding depth. A plant list to aid in selection can be found in Appendix E.20.	Plants suited to the climate and ponding depth are more likely to survive.
<input type="checkbox"/> An irrigation system with a connection to water supply should be provided as needed.	Seasonal irrigation might be needed to keep plants healthy.
<i>Mulch</i>	
<input type="checkbox"/> A minimum of 3 inches of well-aged, shredded hardwood mulch that has been stockpiled or stored for at least 12 months is provided.	Mulch will suppress weeds and maintain moisture for plant growth. Aging mulch kills pathogens and weed seeds and allows the beneficial microbes to multiply.
<i>Media Layer</i>	
<input type="checkbox"/> Media maintains a minimum filtration rate of 5 in/hr over lifetime of facility. An initial filtration rate of 8 to 12 in/hr is recommended to allow for clogging over time; the initial filtration rate should not exceed 12 inches per hour.	A filtration rate of at least 5 inches per hour allows soil to drain between events. The initial rate should be higher than long term target rate to account for clogging over time. However an excessively high initial rate can have a negative impact on treatment performance, therefore an upper limit is needed.
<input type="checkbox"/> Media is a minimum 18 inches deep, meeting either of these two media specifications: City of San Diego Low Impact Development Design Manual (page B-18) (July 2011, unless superseded by more recent edition) or County of San Diego Low Impact Development Handbook: Appendix G -Bioretention Soil Specification (June 2014, unless superseded by more recent edition). Alternatively, for proprietary designs and custom media mixes not meeting the media specifications contained in the City or County LID Manual, the media meets the pollutant treatment performance criteria in Section F.1.	A deep media layer provides additional filtration and supports plants with deeper roots. Standard specifications shall be followed. For non-standard or proprietary designs, compliance with F.1 ensures that adequate treatment performance will be provided.

<i>Siting and Design</i>	<i>Intent/Rationale</i>
<input type="checkbox"/> Media surface area is 3% of contributing area times adjusted runoff factor or greater. Unless demonstrated that the BMP surface area can be smaller than 3%.	<p>Greater surface area to tributary area ratios: a) maximizes volume retention as required by the MS4 Permit and b) decrease loading rates per square foot and therefore increase longevity.</p> <p>Adjusted runoff factor is to account for site design BMPs implemented upstream of the BMP (such as rain barrels, impervious area dispersion, etc.). Refer to Appendix B.2 guidance.</p> <p>Use Worksheet B.5-1 Line 26 to estimate the minimum surface area required per this criteria.</p>
<input type="checkbox"/> Where receiving waters are impaired or have a TMDL for nutrients, the system is designed with nutrient sensitive media design (see fact sheet BF-2).	<p>Potential for pollutant export is partly a function of media composition; media design must minimize potential for export of nutrients, particularly where receiving waters are impaired for nutrients.</p>
<i>Filter Course Layer</i>	
<input type="checkbox"/> A filter course is used to prevent migration of fines through layers of the facility. Filter fabric is not used.	<p>Migration of media can cause clogging of the aggregate storage layer void spaces or subgrade. Filter fabric is more likely to clog.</p>
<input type="checkbox"/> Filter course is washed and free of fines.	<p>Washing aggregate will help eliminate fines that could clog the facility and impede infiltration.</p>
<input type="checkbox"/> Filter course calculations assessing suitability for particle migration prevention have been completed.	<p>Gradation relationship between layers can evaluate factors (e.g., bridging, permeability, and uniformity) to determine if particle sizing is appropriate or if an intermediate layer is needed.</p>
<i>Aggregate Storage Layer</i>	
<input type="checkbox"/> Class 2 Permeable per Caltrans specification 68-1.025 is recommended for the storage layer. Washed, open-graded crushed rock may be used, however a 4-6 inch washed pea gravel	<p>Washing aggregate will help eliminate fines that could clog the aggregate storage layer void spaces or subgrade.</p>

<i>Siting and Design</i>	<i>Intent/Rationale</i>
filter course layer at the top of the crushed rock is required.	
<input type="checkbox"/> The depth of aggregate provided (12-inch typical) and storage layer configuration is adequate for providing conveyance for underdrain flows to the outlet structure.	Proper storage layer configuration and underdrain placement will minimize facility drawdown time.
<i>Inflow, Underdrain, and Outflow Structures</i>	
<input type="checkbox"/> Inflow, underdrains and outflow structures are accessible for inspection and maintenance.	Maintenance will prevent clogging and ensure proper operation of the flow control structures.
<input type="checkbox"/> Inflow velocities are limited to 3 ft./s or less or use energy dissipation methods. (e.g., riprap, level spreader) for concentrated inflows.	High inflow velocities can cause erosion, scour and/or channeling.
<input type="checkbox"/> Curb cut inlets are at least 12 inches wide, have a 4-6 inch reveal (drop) and an apron and energy dissipation as needed.	Inlets must not restrict flow and apron prevents blockage from vegetation as it grows in. Energy dissipation prevents erosion.
<input type="checkbox"/> Underdrain outlet elevation should be a minimum of 3 inches above the bottom elevation of the aggregate storage layer.	A minimal separation from subgrade or the liner lessens the risk of fines entering the underdrain and can improve hydraulic performance by allowing perforations to remain unblocked.
<input type="checkbox"/> Minimum underdrain diameter is 6 inches.	Smaller diameter underdrains are prone to clogging.
<input type="checkbox"/> Underdrains are made of slotted, PVC pipe conforming to ASTM D 3034 or equivalent or corrugated, HDPE pipe conforming to AASHTO 252M or equivalent.	Slotted underdrains provide greater intake capacity, clog resistant drainage, and reduced entrance velocity into the pipe, thereby reducing the chances of solids migration.
<input type="checkbox"/> An underdrain cleanout with a minimum 6-inch diameter and lockable cap is placed every 250 to 300 feet as required based on underdrain length.	Properly spaced cleanouts will facilitate underdrain maintenance.
<input type="checkbox"/> Overflow is safely conveyed to a downstream storm drain system or discharge point Size overflow structure to pass 100-year peak flow	Planning for overflow lessens the risk of property damage due to flooding.

<i>Siting and Design</i>	<i>Intent/Rationale</i>
for on-line infiltration basins and water quality peak flow for off-line basins.	

Conceptual Design and Sizing Approach for Storm Water Pollutant Control Only

To design bioretention with underdrain for storm water pollutant control only (no flow control required), the following steps should be taken:

1. Verify that siting and design criteria have been met, including placement requirements, contributing tributary area, maximum side and finish grade slopes, and the recommended media surface area tributary ratio.
2. Calculate the DCV per Appendix B based on expected site design runoff for tributary areas.
3. Use the sizing worksheet presented in Appendix B.5 to size biofiltration BMPs.

Conceptual Design and Sizing Approach when Storm Water Flow Control is Applicable

Control of flow rates and/or durations will typically require significant surface ponding and/or aggregate storage volumes, and therefore the following steps should be taken prior to determination of storm water pollutant control design. Pre-development and allowable post-project flow rates and durations should be determined as discussed in Chapter 6 of the manual.

1. Verify that siting and design criteria have been met, including placement requirements, contributing tributary area, maximum side and finish grade slopes, and the recommended media surface area tributary ratio.
2. Iteratively determine the facility footprint area, surface ponding and/or aggregate storage layer depth required to provide detention storage to reduce flow rates and durations to allowable limits. Flow rates and durations can be controlled from detention storage by altering outlet structure orifice size(s) and/or water control levels. Multi-level orifices can be used within an outlet structure to control the full range of flows.
3. If bioretention with underdrain cannot fully provide the flow rate and duration control required by this manual, an upstream or downstream structure with significant storage volume such as an underground vault can be used to provide remaining controls.
4. After bioretention with underdrain has been designed to meet flow control requirements, calculations must be completed to verify if storm water pollutant control requirements to treat the DCV have been met.

E.13 BF-2 Nutrient Sensitive Media Design

Some studies of bioretention with underdrains have observed export of nutrients, particularly inorganic nitrogen (nitrate and nitrite) and dissolved phosphorus. This has been observed to be a short-lived phenomenon in some studies or a long term issue in some studies. The composition of the soil media, including the chemistry of individual elements is believed to be an important factor in the potential for nutrient export. Organic amendments, often compost, have been identified as the most likely source of nutrient export. The quality and stability of organic amendments can vary widely.

The biofiltration media specifications contained in the County of San Diego Low Impact Development Handbook: Appendix G -Bioretention Soil Specification (June 2014, unless superseded by more recent edition) and the City of San Diego Low Impact Development Design Manual (page B-18) (July 2011, unless superseded by more recent edition) were developed with consideration of the potential for nutrient export. These specifications include criteria for individual component characteristics and quality in order to control the overall quality of the blended mixes. As of the publication of this manual, the June 2014 County of San Diego specifications provide more detail regarding mix design and quality control.

The City and County specifications noted above were developed for general purposes to meet permeability and treatment goals. In cases where the BMP discharges to receiving waters with nutrient impairments or nutrient TMDLs, the biofiltration media should be designed with the specific goal of minimizing the potential for export of nutrients from the media. Therefore, in addition to adhering to the City or County media specifications, the following guidelines should be followed:

1. Select plant palette to minimize plant nutrient needs

A landscape architect or agronomist should be consulted to select a plant palette that minimizes nutrient needs. Utilizing plants with low nutrient needs results in less need to enrich the biofiltration soil mix. If nutrient quantity is then tailored to plants with lower nutrient needs, these plants will generally have less competition from weeds, which typically need higher nutrient content. The following practices are recommended to minimize nutrient needs of the plant palette:

- **Utilize native, drought-tolerant plants and grasses where possible.** Native plants generally have a broader tolerance for nutrient content, and can be longer lived in leaner/lower nutrient soils.
- **Start plants from smaller starts or seed.** Younger plants are generally more tolerant of lower nutrient levels and tend to help develop soil structure as they grow. Given the lower cost of smaller plants, the project should be able to accept a plant mortality rate that is somewhat higher than starting from larger plants and providing high organic content.

2. Minimize excess nutrients in media mix

Once the low-nutrient plant palette is established (item 1), the landscape architect and/or agronomist should be consulted to assist in the design of a biofiltration media to balance the interests of plant

establishment, water retention capacity (irrigation demand), and the potential for nutrient export. The following guidelines should be followed:

- **The mix should not exceed the nutrient needs of plants.** In conventional landscape design, the nutrient needs of plants are often exceeded intentionally in order to provide a factor of safety for plant survival. This practice must be avoided in biofiltration media as excess nutrients will increase the chance of export. The mix designer should keep in mind that nutrients can be added later (through mulching, tilling of amendments into the surface), but it is not possible to remove nutrients, once added.
- **The actual nutrient content and organic content of the selected organic amendment source should be determined when specifying mix proportions.** Nutrient content (i.e., C:N ratio; plant extractable nutrients) and organic content (i.e., % organic material) are relatively inexpensive to measure via standard agronomic methods and can provide important information about mix design. If mix design relies on approximate assumption about nutrient/organic content and this is not confirmed with testing (or the results of prior representative testing), it is possible that the mix could contain much more nutrient than intended.
- **Nutrients are better retained in soils with higher cation exchange capacity.** Cation exchange capacity can be increased through selection of organic material with naturally high cation exchange capacity, such as peat or coconut coir pith, and/or selection of inorganic material with high cation exchange capacity such as some sands or engineered minerals (e.g., low P-index sands, zeolites, rhyolites, etc.). Including higher cation exchange capacity materials would tend to reduce the net export of nutrients. Natural silty materials also provide cation exchange capacity; however potential impacts to permeability need to be considered.
- **Focus on soil structure as well as nutrient content.** Soil structure is loosely defined as the ability of the soil to conduct and store water and nutrients as well as the degree of aeration of the soil. Soil structure can be more important than nutrient content in plant survival and biologic health of the system. If a good soil structure can be created with very low amounts of organic amendment, plants survivability should still be provided. While soil structure generally develops with time, biofiltration media can be designed to promote earlier development of soil structure. Soil structure is enhanced by the use of amendments with high humus content (as found in well-aged organic material). In addition, soil structure can be enhanced through the use of organic material with a distribution of particle sizes (i.e., a more heterogeneous mix).
- **Consider alternatives to compost.** Compost, by nature, is a material that is continually evolving and decaying. It can be challenging to determine whether tests previously done on a given compost stock are still representative. It can also be challenging to determine how the properties of the compost will change once placed in the media bed. More stable materials such as aged coco coir pith, peat, biochar, shredded bark, and/or other amendments should be considered.

With these considerations, it is anticipated that less than 10 percent organic amendment by volume

could be used, while still balancing plant survivability and water retention. If compost is used, designers should strongly consider utilizing less than 10 percent by volume.

3. Design with partial retention and/or internal water storage

An internal water storage zone, as described in Fact Sheet PR-1 is believed to improve retention of nutrients. For lined systems, an internal water storage zone worked by providing a zone that fluctuates between aerobic and anaerobic conditions, resulting in nitrification/denitrification. In soils that will allow infiltration, a partial retention design (PR-1) allows significant volume reduction and can also promote nitrification/denitrification.

Acknowledgment: This fact sheet has been adapted from the Orange County Technical Guidance Document (May 2011). It was originally developed based on input from: Deborah Deets, City of Los Angeles Bureau of Sanitation, Drew Ready, Center for Watershed Health, Rick Fisher, ASLA, City of Los Angeles Bureau of Engineering, Dr. Garn Wallace, Wallace Laboratories, Glen Dake, GDML, and Jason Schmidt, Tree People. The guidance provided herein does not reflect the individual opinions of any individual listed above and should not be cited or otherwise attributed to those listed.

E.14 BF-3 Proprietary Biofiltration Systems

The purpose of this fact sheet is to help explain the potential role of proprietary BMPs in meeting biofiltration requirements, when full retention of the DCV is not feasible. The fact sheet does not describe design criteria like the other fact sheets in this appendix because this information varies by BMP product model.

Criteria for Use of a Proprietary BMP as a Biofiltration BMP

A proprietary BMP may be acceptable as a “biofiltration BMP” under the following conditions:

- (1) The BMP meets the minimum design criteria listed in Appendix F, including the pollutant treatment performance standard in Appendix F.1;
- (2) The BMP is designed and maintained in a manner consistent with its performance certifications (See explanation in Appendix F.2); and
- (3) The BMP is acceptable at the discretion of the City Engineer. The City Engineer has no obligation to accept any proprietary biofiltration BMP. In determining the acceptability of a BMP, the City Engineer should consider, as applicable, (a) the data submitted; (b) representativeness of the data submitted; (c) consistency of the BMP performance claims with pollutant control objectives; certainty of the BMP performance claims; (d) for projects within the public right of way and/or public projects: maintenance requirements, cost of maintenance activities, relevant previous local experience with operation and maintenance of the BMP type, ability to continue to operate the system in event that the vending company is no longer operating as a business; and (e) other relevant factors.

Guidance for Sizing a Proprietary BMP as a Biofiltration BMP

Proprietary biofiltration BMPs must meet the same sizing guidance as non-proprietary BMPs. Sizing is typically based on capturing and treating 1.50 times the DCV not reliably retained. Guidance for sizing biofiltration BMPs to comply with requirements of this manual is provided in Appendix F.2.

E.15 FT-1 Vegetated Swales



MS4 Permit Category

Flow-through Treatment Control

Manual Category

Flow-through Treatment Control

Applicable Performance Standard

Pollutant Control

Primary Benefits

Treatment
Volume Reduction (Incidental)
Peak Flow Attenuation

Location: Eastlake Business Center, Chula Vista, California; Photo Credit: Eric Mosolgo

Description

Vegetated swales are shallow, open channels that are designed to remove storm water pollutants by physically straining/filtering runoff through vegetation in the channel. Swales can be used in place of traditional curbs and gutters and are well-suited for use in linear transportation corridors to provide both conveyance and treatment via filtration. An effectively designed vegetated swale achieves uniform sheet flow through densely vegetated areas. When soil conditions allow, infiltration and volume reduction are enhanced by adding a gravel drainage layer underneath the swale. Vegetated swales with a subsurface media layer can provide enhanced infiltration, water retention, and pollutant-removal capabilities. Pollutant removal effectiveness can also be maximized by increasing the hydraulic residence time of water in swale using weirs or check dams.

Note that the City of Vista does not have an alternative compliance program, so flow through treatment control BMPs should only be used for pre-treatment as of the implementation date of this Manual.

Typical vegetated swale components include:

- Inflow distribution mechanisms (e.g., flow spreader)
- Surface flow
- Vegetated surface layer
- Check dams (if required)
- Optional aggregate storage layer with underdrain(s)

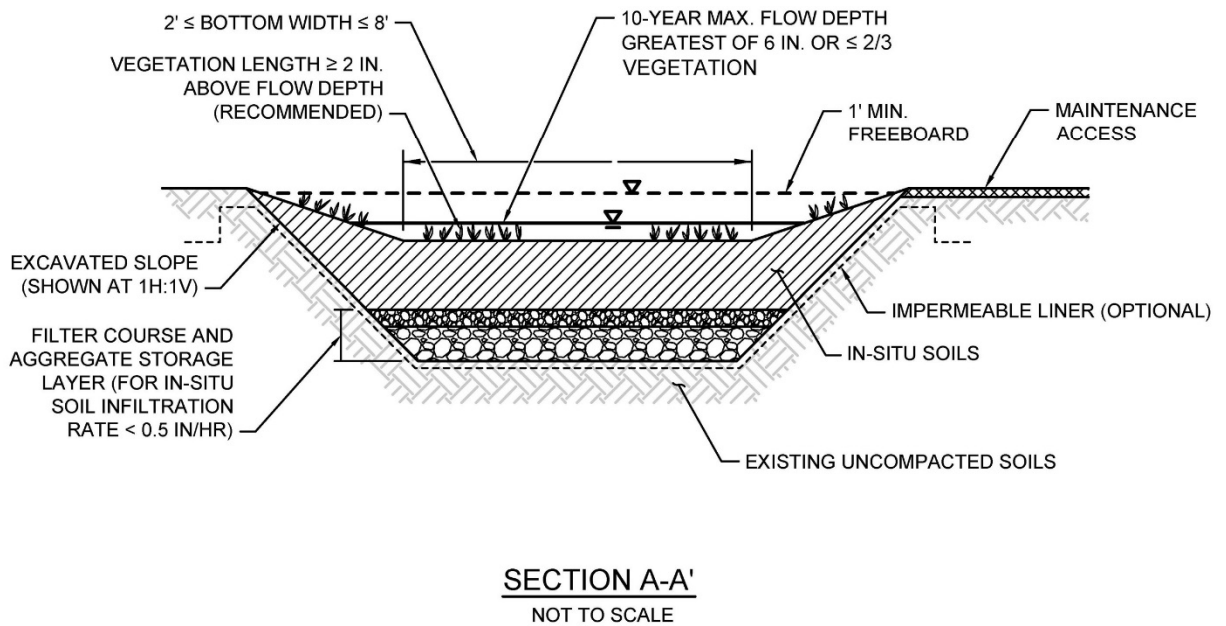
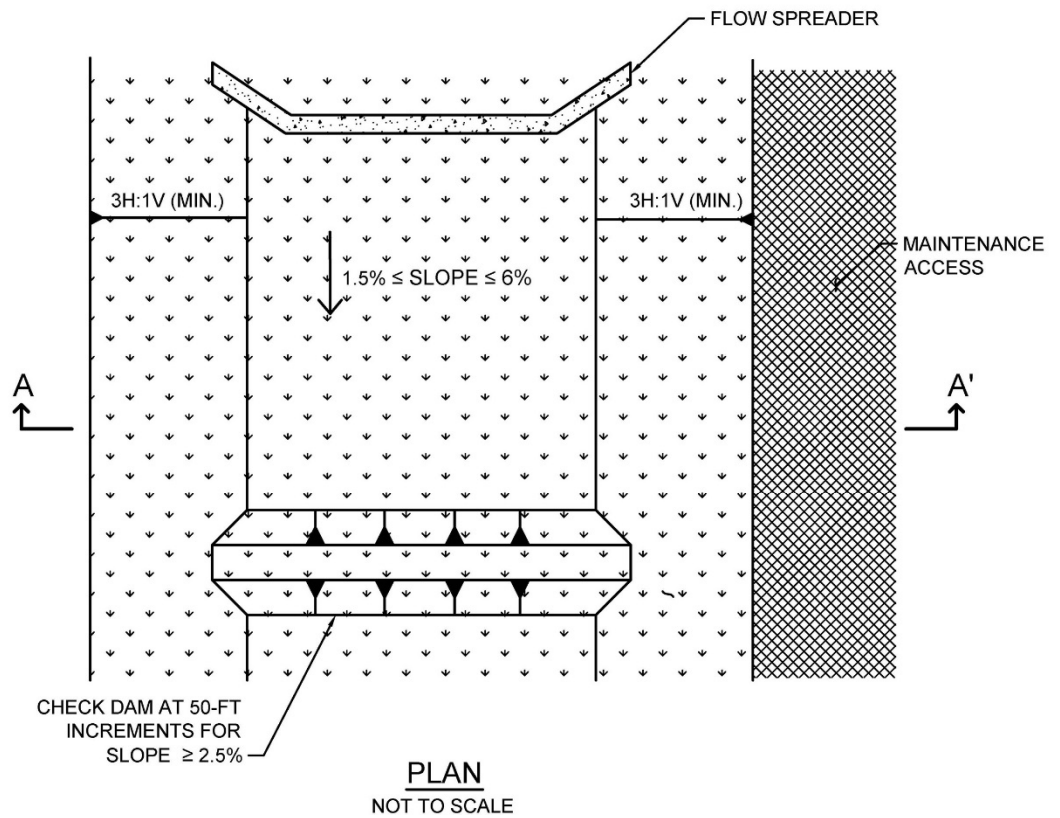

Typical plan and Section view of a Vegetated Swale BMP

Design Adaptations for Project Goals

Site design BMP to reduce runoff volumes and storm peaks. Swales without underdrains are an alternative to lined channels and pipes and can provide volume reduction through infiltration. Swales can also reduce the peak runoff discharge rate by increasing the time of concentration of the site and decreasing runoff volumes and velocities.

Flow-through treatment BMP for storm water pollutant control. The system is lined or un-lined to provide incidental infiltration with an underdrain and designed to provide pollutant removal through settling and filtration in the channel vegetation (usually grasses). This configuration is considered to provide flow-through treatment via horizontal surface flow through the swale. Sizing for flow-through treatment control is based on the surface flow rate through the swale that meets water quality treatment performance objectives.

Design Criteria and Considerations

Vegetated swales must meet the following design criteria. Deviations from the below criteria may be approved at the discretion of the City Engineer if it is determined to be appropriate:

<i>Siting and Design</i>	<i>Intent/Rationale</i>
<input type="checkbox"/> Placement observes geotechnical recommendations regarding potential hazards (e.g., slope stability, landslides, and liquefaction zones) and setbacks (e.g., slopes, foundations, utilities).	Must not negatively impact existing site geotechnical concerns.
<input type="checkbox"/> An impermeable liner or other hydraulic restriction layer is included if site constraints indicate that infiltration or lateral flows should not be allowed.	Lining prevents storm water from impacting groundwater and/or sensitive environmental or geotechnical features. Incidental infiltration, when allowable, can aid in pollutant removal and groundwater recharge.
<input type="checkbox"/> Contributing tributary area ≤ 2 acres.	Higher ratios increase the potential for clogging but may be acceptable for relatively clean tributary areas.
<input type="checkbox"/> Longitudinal slope is $\geq 1.5\%$ and $\leq 6\%$.	Flatter swales facilitate increased water quality treatment while minimum slopes prevent ponding.
<input type="checkbox"/> For site design goal, in-situ soil infiltration rate ≥ 0.5 in/hr (if < 0.5 in/hr, an underdrain is required and design goal is for pollutant control only).	Well-drained soils provide volume reduction and treatment. An underdrain should only be provided when soil infiltration rates are low or per geotechnical or groundwater concerns.

<i>Siting and Design</i>	<i>Intent/Rationale</i>
Surface Flow	
<input type="checkbox"/> Maximum flow depth is ≤ 6 inches or $\leq \frac{2}{3}$ the vegetation length, whichever is greater. Ideally, flow depth will be ≥ 2 inches below shortest plant species.	Flow depth must fall within the height range of the vegetation for effective water quality treatment via filtering.
A minimum of 1 foot of freeboard is provided.	Freeboard minimizes risk of uncontrolled surface discharge.
<input type="checkbox"/> Cross sectional shape is trapezoidal or parabolic with side slopes $\geq 3H:1V$.	Gentler side slopes are safer, less prone to erosion, able to establish vegetation more quickly and easier to maintain.
<input type="checkbox"/> Bottom width is ≥ 2 feet and ≤ 8 feet.	A minimum of 2 feet minimizes erosion. A maximum of 8 feet prevents channel braiding.
<input type="checkbox"/> Minimum hydraulic residence time ≥ 10 minutes.	Longer hydraulic residence time increases pollutant removal.
<input type="checkbox"/> Swale is designed to safely convey the 10-yr storm event unless a flow splitter is included to allow only the water quality event.	Planning for larger storm events lessens the risk of property damage due to flooding.
<input type="checkbox"/> Flow velocity is ≤ 1 ft./s for water quality event. Flow velocity for 10-yr storm event is ≤ 3 ft./s.	Lower flow velocities provide increased pollutant removal via filtration and minimize erosion.
Vegetated Surface Layer (amendment with media is Optional)	
<input type="checkbox"/> Soil is amended with 2 inches of media mixed into the top 6 inches of in-situ soils, as needed, to promote plant growth (optional). For enhanced pollutant control, 2 feet of media can be used in place of in-situ soils. Media meets either of these two media specifications: City of San Diego Low Impact Development Design Manual, July 2011 (page B-18); Or County of San Diego Low Impact Development Handbook, June 2014: Appendix G -Bioretention Soil Specification.	Amended soils aid in plant establishment and growth. Media replacement for in-situ soils can improve water quality treatment and site design volume reduction.

<i>Siting and Design</i>		<i>Intent/Rationale</i>
<input type="checkbox"/>	Vegetation is appropriately selected low-growing, erosion-resistant plant species that effectively bind the soil, thrive under site-specific climatic conditions and require little or no irrigation.	Plants suited to the climate and expected flow conditions are more likely to survive.
<i>Check Dams</i>		
<input type="checkbox"/>	Check dams are provided at 50-foot increments for slopes $\geq 2.5\%$.	Check dams prevent erosion and increase the hydraulic residence time by lowering flow velocities and providing ponding opportunities.
<i>Filter Course Layer (For Underdrain Design)</i>		
<input type="checkbox"/>	A filter course is used to prevent migration of fines through layers of the facility. Filter fabric is not used.	Migration of media can cause clogging of the aggregate storage layer void spaces or subgrade. Filter fabric is more likely to clog.
<input type="checkbox"/>	Filter course is washed and free of fines.	Washing aggregate will help eliminate fines that could clog the facility and impede infiltration.
<input type="checkbox"/>	Filter course calculations assessing suitability for particle migration prevention have been completed.	Gradation relationship between layers can evaluate factors (e.g., bridging, permeability, and uniformity) to determine if particle sizing is appropriate or if an intermediate layer is needed.
<i>Aggregate Storage Layer (For Underdrain Design)</i>		
<input type="checkbox"/>	The depth of aggregate provided (12-inch typical) and storage layer configuration is adequate for providing conveyance for underdrain flows to the outlet structure.	Proper storage layer configuration and underdrain placement will minimize facility drawdown time.
<input type="checkbox"/>	Aggregate used for the aggregate storage layer is washed and free of fines.	Washing aggregate will help eliminate fines that could clog aggregate storage layer void spaces or underdrain.
<i>Inflow and Underdrain Structures</i>		
<input type="checkbox"/>	Inflow and underdrains are accessible for inspection and maintenance.	Maintenance will prevent clogging and ensure proper operation of the flow control structures.

<i>Siting and Design</i>		<i>Intent/Rationale</i>
<input type="checkbox"/>	Underdrain outlet elevation should be a minimum of 3 inches above the bottom elevation of the aggregate storage layer.	A minimal separation from subgrade or the liner lessens the risk of fines entering the underdrain and can improve hydraulic performance by allowing perforations to remain unblocked.
<input type="checkbox"/>	Minimum underdrain diameter is 6 inches.	Smaller diameter underdrains are prone to clogging.
<input type="checkbox"/>	Underdrains are made of slotted, PVC pipe conforming to ASTM D 3034 or equivalent or corrugated, HDPE pipe conforming to AASHTO 252M or equivalent.	Slotted underdrains provide greater intake capacity, clog resistant drainage, and reduced entrance velocity into the pipe, thereby reducing the chances of solids migration.
<input type="checkbox"/>	An underdrain cleanout with a minimum 6-inch diameter and lockable cap is placed every 250 to 300 feet as required based on underdrain length.	Properly spaced cleanouts will facilitate underdrain maintenance.

Conceptual Design and Sizing Approach for Site Design

1. Determine the areas where vegetated swales can be used in the site design to replace traditional curb and gutter facilities and provide volume reduction through infiltration.

Conceptual Design and Sizing Approach for Storm Water Pollutant Control Only

To design vegetated swales for storm water pollutant control only, the following steps should be taken:

1. Verify that siting and design criteria have been met, including bottom width and longitudinal and side slope requirements.
2. Calculate the design flow rate per Appendix B based on expected site design runoff for tributary areas.
3. Use the sizing worksheet to determine flow-through treatment sizing of the vegetated swale and if flow velocity, flow depth, and hydraulic residence time meet required criteria. Swale configuration should be adjusted as necessary to meet design requirements.

E.16 FT-2 Media Filters

MS4 Permit Category

Flow-through Treatment Control

Manual Category

Flow-through Treatment Control

Applicable Performance Standard

Pollutant Control

Flow Control

Primary Benefits

Treatment

Peak Flow Attenuation (Optional)



Photo Credit: Contech Stormwater Solutions

Description

Media filters are manufactured devices that consist of a series of modular filters packed with engineered media that can be contained in a catch basin, manhole, or vault that provide treatment through filtration and sedimentation. The manhole or vault may be divided into multiple chambers where the first chamber acts as a presettling basin for removal of coarse sediment while the next

Appendix E: BMP Design Fact Sheets

chamber acts as the filter bay and houses the filter cartridges. A variety of media types are available from various manufacturers that can target pollutants of concern via primarily filtration, sorption, ion exchange, and precipitation. **Specific products must be selected to meet the flow-through BMP selection requirements described in Appendix B.6.** Treatment effectiveness is contingent upon proper maintenance of filter units.

Note that the City of Vista does not have an alternative compliance program, so flow through treatment control BMPs should only be used for pre-treatment as of the implementation date of this Manual.

Typical media filter components include:

- Vault for flow storage and media housing
- Inlet and outlet
- Media filters

Design Adaptations for Project Goals

Flow-through treatment BMP for storm water pollutant control. Water quality treatment is provided through filtration. This configuration is considered to provide flow-through treatment, not biofiltration treatment. Storage provided within the vault restricted by an outlet is considered detention storage and is included in calculations for the flow-through treatment volume.

Integrated storm water flow control and pollutant control configuration. Media filters can also be designed for flow rate and duration control via additional detention storage. The vault storage can be designed to accommodate higher volumes than the storm water pollutant control volume and can utilize multi-stage outlets to mitigate both the duration and rate of flows within a prescribed range.

Design Criteria and Considerations

Media filters must meet the following design criteria. Deviations from the below criteria may be approved at the discretion of the City Engineer if it is determined to be appropriate:

<i>Siting and Design</i>	<i>Intent/Rationale</i>
<input type="checkbox"/> Placement observes geotechnical recommendations regarding potential hazards (e.g., slope stability, landslides, and liquefaction zones) and setbacks (e.g., slopes, foundations, utilities).	Must not negatively impact existing site geotechnical concerns.
<input type="checkbox"/> Recommended for tributary areas with limited available surface area or where surface BMPs would restrict uses.	Maintenance needs may be more labor intensive for media filters than surface BMPs. Lack of surface visibility creates additional risk that maintenance needs may not be completed in a timely manner.
<input type="checkbox"/> Vault storage drawdown time ≤ 96 hours.	Provides vector control.
<input type="checkbox"/> Vault storage drawdown time ≤ 36 hours if the vault is used for equalization of flows for pollutant treatment.	Provides required capacity to treat back to back storms. Exception to the 36 hour drawdown criteria is allowed if additional vault storage is provided using the curves in Appendix B.4.2.
<i>Inflow and Outflow Structures</i>	
<input type="checkbox"/> Inflow and outflow structures are accessible by required equipment (e.g., vector truck) for inspection and maintenance.	Maintenance will prevent clogging and ensure proper operation of the flow control structures.

Conceptual Design and Sizing Approach for Storm Water Pollutant Control Only

To design a media filter for storm water pollutant control only (no flow control required), the following steps should be taken

1. Verify that the selected BMP complies with BMP selection requirements in Appendix B.6.
2. Verify that placement and tributary area requirements have been met.
3. Calculate the required DCV and/or flow rate per Appendix B.6.3 based on expected site design runoff for tributary areas.
4. Media filter can be designed either for DCV or flow rate. To estimate the drawdown time, divide the vault storage by the treatment rate of media filters.

Conceptual Design and Sizing Approach when Storm Water Flow Control is Applicable

Control of flow rates and/or durations will typically require significant vault storage volume, and therefore the following steps should be taken prior to determination of storm water pollutant control design. Pre-development and allowable post-project flow rates and durations should be determined as discussed in Chapter 6 of the manual.

1. Verify that placement and tributary area requirements have been met.
2. Iteratively determine the vault storage volume required to provide detention storage to reduce flow rates and durations to allowable limits. Flow rates and durations can be controlled from detention storage by altering outlet structure orifice size(s) and/or water control levels. Multi-level orifices can be used within an outlet structure to control the full range of flows to MS4.
3. If a media filter cannot fully provide the flow rate and duration control required by this manual, an upstream or downstream structure with appropriate storage volume such as an underground vault can be used to provide remaining controls.
4. After the media filter has been designed to meet flow control requirements, calculations must be completed to verify if storm water pollutant control requirements to treat the DCV have been met.
5. Verify that the vault drawdown time is 96 hours or less. To estimate the drawdown time:
 - a. Divide the vault volume by the filter surface area.
 - b. Divide the result (a) by the design filter rate.

E.17 FT-3 Sand Filters



Photo Credit: City of San Diego LID Manual

MS4 Permit Category

Flow-through Treatment Control

Manual Category

Flow-through Treatment Control

Applicable Performance Standard

Pollutant Control

Flow Control

Primary Benefits

Treatment

Volume Reduction (Incidental)

Peak Flow Attenuation (Optional)

Description

Sand filters operate by filtering storm water through a constructed sand bed with an underdrain system. Runoff enters the filter and spreads over the surface. Sand filter beds can be enclosed within concrete structures or within earthen containment. As flows increase, water backs up on the surface of the filter where it is held until it can percolate through the sand. The treatment pathway is downward (vertical) through the media to an underdrain system that is connected to the downstream storm drain system. As storm water passes through the sand, pollutants are trapped on the surface of the filter, in the small pore spaces between sand grains or are adsorbed to the sand surface. The high filtration rates of sand filters, which allow a large runoff volume to pass through the media in a short amount of time, can provide efficient treatment for storm water runoff.

Note that the City of Vista does not have an alternative compliance program, so flow through treatment control BMPs should only be used for pre-treatment as of the implementation date of this Manual.

Typical sand filter components include:

- Forebay for pretreatment/energy dissipation
- Surface ponding for captured flows
- Sand filter bed
- Aggregate storage layer with underdrain(s)
- Overflow structure

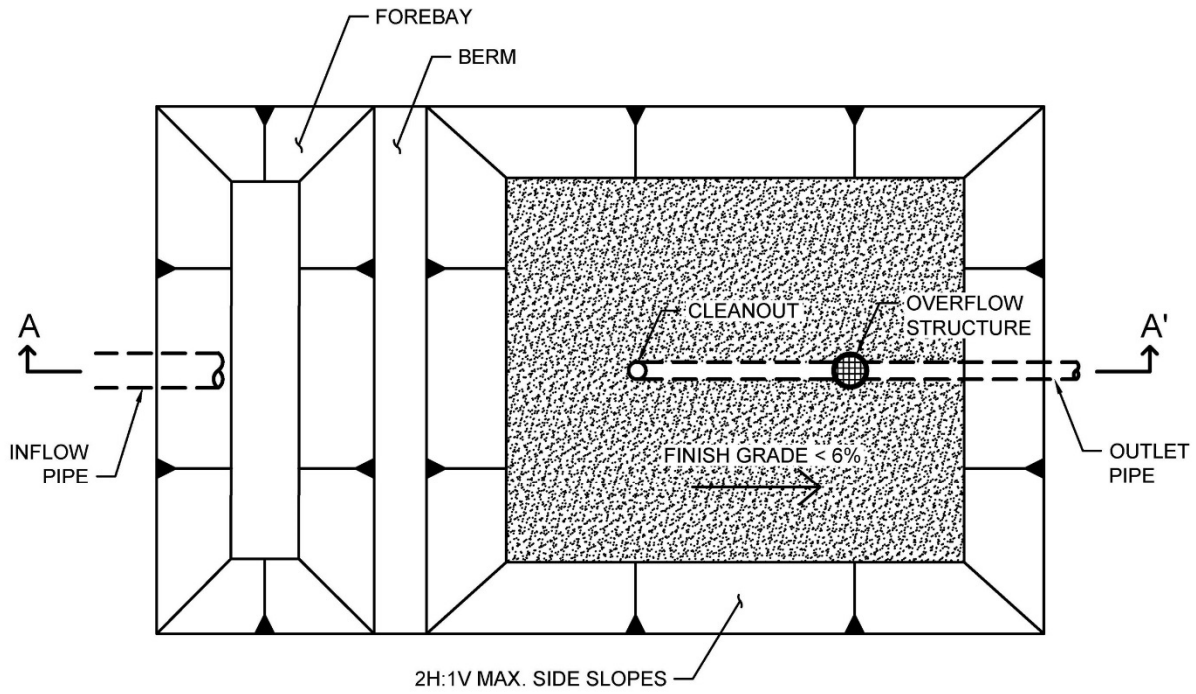

PLAN
NOT TO SCALE

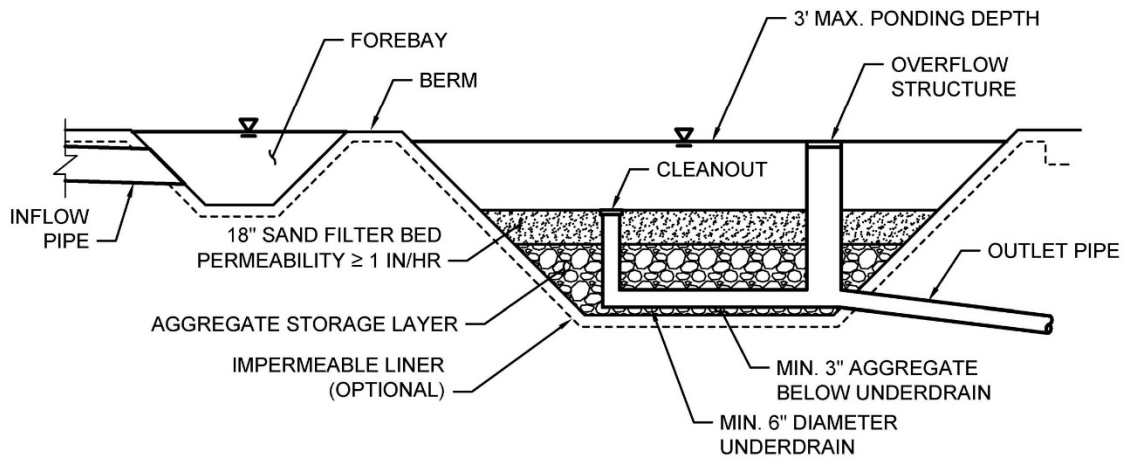

SECTION A-A'
NOT TO SCALE

Typical plan and Section view of a Sand Filter BMP

Design Adaptations for Project Goals

Flow-through treatment BMP for storm water pollutant control. The system is lined or un-lined to provide incidental infiltration, and an underdrain is provided at the bottom to carry away filtered runoff. This configuration is considered to provide flow-through treatment via vertical flow through the sand filter bed. Storage provided above the underdrain within surface ponding, the sand filter bed, and aggregate storage is considered included in the flow-through treatment volume. Saturated storage within the aggregate storage layer can be added to this design by including an upturned elbow installed at the downstream end of the underdrain or via an internal weir structure designed to maintain a specific water level elevation.

Integrated storm water flow control and pollutant control configuration. The system can be designed to provide flow rate and duration control by primarily providing increased surface ponding and/or having a deeper aggregate storage layer above the underdrain. This will allow for significant detention storage, which can be controlled via inclusion of an outlet structure at the downstream end of the underdrain.

Design Criteria and Considerations

Sand filters must meet the following design criteria. Deviations from the below criteria may be approved at the discretion of the City Engineer if it is determined to be appropriate:

<i>Siting and Design</i>	<i>Intent/Rationale</i>
<input type="checkbox"/> Placement observes geotechnical recommendations regarding potential hazards (e.g., slope stability, landslides, and liquefaction zones) and setbacks (e.g., slopes, foundations, utilities).	Must not negatively impact existing site geotechnical concerns.
<input type="checkbox"/> An impermeable liner or other hydraulic restriction layer is included if site constraints indicate that infiltration or lateral flows should not be allowed.	Lining prevents storm water from impacting groundwater and/or sensitive environmental or geotechnical features. Incidental infiltration, when allowable, can aid in pollutant removal and groundwater recharge.
<input type="checkbox"/> Contributing tributary area (≤ 5 acres).	Bigger BMPs require additional design features for proper performance. Contributing tributary area greater than 5 acres may be allowed at the discretion of the [City Engineer} if the following conditions are met: 1) incorporate design features (e.g. flow spreaders) to minimizing short circuiting of flows in the BMP and 2) incorporate additional design features requested by the

<i>Siting and Design</i>	<i>Intent/Rationale</i>
	City Engineer for proper performance of the regional BMP.
<input type="checkbox"/> Finish grade of facility is < 6%.	Flatter surfaces reduce erosion and channelization within the facility.
<input type="checkbox"/> Earthen side slopes are $\geq 3H:1V$.	Gentler side slopes are safer, less prone to erosion, able to establish vegetation more quickly and easier to maintain.
<input type="checkbox"/> Surface ponding is limited to a 36-hour drawdown time.	Provides required capacity to treat back to back storms. Exception to the 36 hour drawdown criteria is allowed if additional surface storage is provided using the curves in Appendix B.4.2.
<input type="checkbox"/> Surface ponding is limited to a 96-hour drawdown time.	Prolonged surface ponding can create a vector hazard.
<input type="checkbox"/> Maximum ponding depth does not exceed 3 feet.	Surface ponding capacity lowers subsurface storage requirements and results in lower cost facilities. Deep surface ponding raises safety concerns.
<input type="checkbox"/> Sand filter bed consists of clean washed concrete or masonry sand (passing ¼ inch sieve) or sand similar to the ASTM C33 gradation.	Washing sand will help eliminate fines that could clog the void spaces of the aggregate storage layer.
<input type="checkbox"/> Sand filter bed permeability is at least 1 in/hr.	A high filtration rate through the media allows flows to quickly enter the aggregate storage layer, thereby minimizing bypass.
<input type="checkbox"/> Sand filter bed depth is at least 18 inches deep.	Different pollutants are removed in various zones of the media using several mechanisms. Some pollutants bound to sediment, such as metals, are typically removed within 18 inches of the media.
<input type="checkbox"/> Aggregate storage should be washed, bank-run gravel.	Washing aggregate will help eliminate fines that could clog the aggregate storage layer void spaces or subgrade.
<input type="checkbox"/> The depth of aggregate provided (12-inch typical) and storage layer configuration is adequate for providing conveyance for underdrain flows to the outlet structure.	Proper storage layer configuration and underdrain placement will minimize facility drawdown time.

<i>Siting and Design</i>	<i>Intent/Rationale</i>
<input type="checkbox"/> Inflow, underdrains and outflow structures are accessible for inspection and maintenance.	Maintenance will prevent clogging and ensure proper operation of the flow control structures.
<input type="checkbox"/> Inflow must be non-erosive sheet flow (≤ 3 ft./s) unless an energy-dissipation device, flow diversion/splitter or forebay is installed.	Concentrated flow and/or excessive volumes can cause erosion in a sand filter and can be detrimental to the treatment capacity of the system.
<input type="checkbox"/> Underdrain outlet elevation should be a minimum of 3 inches above the bottom elevation of the aggregate storage layer.	A minimal separation from subgrade or the liner lessens the risk of fines entering the underdrain and can improve hydraulic performance by allowing perforations to remain unblocked.
<input type="checkbox"/> Minimum underdrain diameter is 6 inches.	Smaller diameter underdrains are prone to clogging.
<input type="checkbox"/> Underdrains should be made of slotted, PVC pipe conforming to ASTM D 3034 or equivalent or corrugated, HDPE pipe conforming to AASHTO 252M or equivalent.	Slotted underdrains provide greater intake capacity, clog resistant drainage, and reduced entrance velocity into the pipe, thereby reducing the chances of solids migration.
<input type="checkbox"/> Overflow is safely conveyed to a downstream storm drain system or discharge point.	Planning for overflow lessens the risk of property damage due to flooding.

Conceptual Design and Sizing Approach for Storm Water Pollutant Control Only

To design a sand filter for storm water pollutant control only (no flow control required), the following steps should be taken:

1. Verify that siting and design criteria have been met, including placement requirements, contributing tributary area, and maximum finish grade slope.
2. Calculate the required DCV and/or flow rate per Appendix B.6.3 based on expected site design runoff for tributary areas.
3. Sand filter can be designed either for DCV or flow rate. To estimate the drawdown time, divide the average ponding depth by the permeability of the filter sand.

Conceptual Design and Sizing Approach when Storm Water Flow Control is Applicable

Control of flow rates and/or durations will typically require significant surface ponding and/or

Appendix E: BMP Design Fact Sheets

aggregate storage volumes, and therefore the following steps should be taken prior to determination of storm water pollutant control design. Pre-development and allowable post-project flow rates and durations should be determined as discussed in Chapter 6 of the Manual.

1. Verify that siting and design criteria have been met, including placement requirements, contributing tributary area, and maximum finish grade slope.
2. Iteratively determine the facility footprint area, surface ponding and/or aggregate storage layer depth required to provide detention storage to reduce flow rates and durations to allowable limits. Flow rates and durations can be controlled from detention storage by altering outlet structure orifice size(s) and/or water control levels. Multi-level orifices can be used within an outlet structure to control the full range of flows.
3. If a sand filter cannot fully provide the flow rate and duration control required by the MS4 permit, an upstream or downstream structure with appropriate storage volume such as an underground vault can be used to provide remaining controls.
4. After the sand filter has been designed to meet flow control requirements, calculations must be completed to verify if storm water pollutant control requirements to treat the DCV have been met.

E.18 FT-4 Dry Extended Detention Basin



Location: Rolling Hills Ranch, Chula Vista, California; Photo Credit: Eric Mosolgo

MS4 Permit Category

Flow-through Treatment Control

Manual Category

Flow-through Treatment Control

Applicable Performance Standard

Pollutant Control

Flow Control

Primary Benefits

Treatment

Volume Reduction (Incidental)

Peak Flow Attenuation

Description

Dry extended detention basins are basins that have been designed to detain storm water for an extended period to allow sedimentation and typically drain completely between storm events. A portion of the dissolved pollutant load may also be removed by filtration, uptake by vegetation, and/or through infiltration. The slopes, bottom, and forebay of dry extended detention basins are typically vegetated. Considerable storm water volume reduction can occur in dry extended detention basins when they are located in permeable soils and are not lined with an impermeable barrier. Dry extended detention basins are generally appropriate for developments of ten acres or larger, and have the potential for multiple uses including parks, playing fields, tennis courts, open space, and overflow parking lots. They can also be used to provide flow control by modifying the outlet control structure and providing additional detention storage.

Note that the City of Vista does not have an alternative compliance program, so flow through treatment control BMPs should only be used for pre-treatment as of the implementation date of this Manual.

Typical dry extended detention basins components include:

- Forebay for pretreatment
- Surface ponding for captured flows
- Vegetation selected based on basin use, climate, and ponding depth
- Low flow channel, outlet, and overflow device

- Impermeable liner or uncompacted native soils at the bottom of the facility

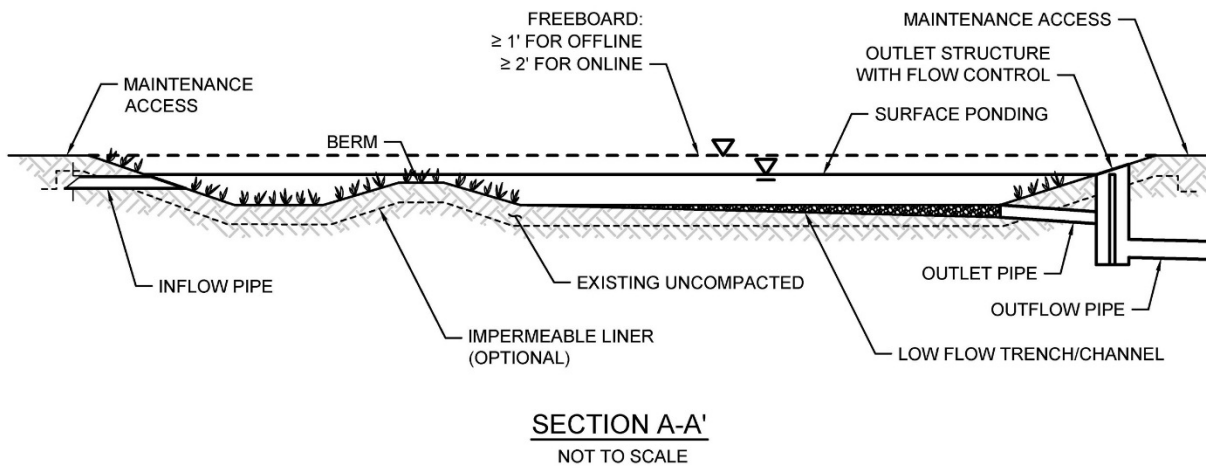
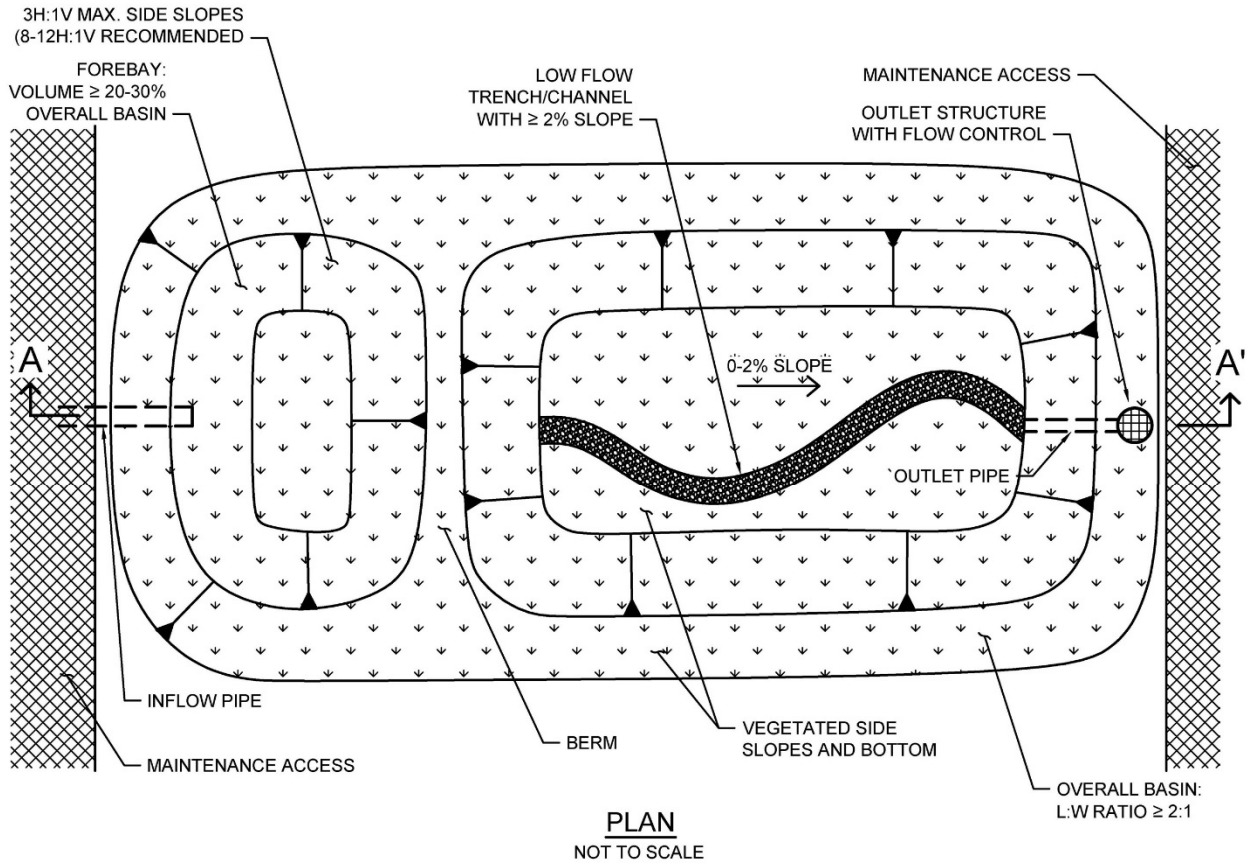

Typical plan and Section view of a Dry Extended Detention Basin BMP

Design Adaptations for Project Goals

Flow-through treatment BMP for storm water pollutant control. The system is lined or un-lined to provide incidental infiltration and designed to detain storm water to allow particulates and associated pollutants to settle out. This configuration is considered to provide flow-through treatment, not biofiltration treatment. Storage provided as surface ponding above a restricted outlet invert is considered detention storage and is included in calculations for the flow-through treatment volume.

Integrated storm water flow control and pollutant control configuration. Dry extended detention basins can also be designed for flow control. The surface ponding can be designed to accommodate higher volumes than the storm water pollutant control volume and can utilize multi-stage outlets to mitigate both the duration and rate of flows within a prescribed range.

Design Criteria and Considerations

Dry extended detention basins must meet the following design criteria. Deviations from the below criteria may be approved at the discretion of the City Engineer if it is determined to be appropriate:

<i>Siting and Design</i>	<i>Intent/Rationale</i>
<input type="checkbox"/> Placement observes geotechnical recommendations regarding potential hazards (e.g., slope stability, landslides, and liquefaction zones) and setbacks (e.g., slopes, foundations, utilities).	Must not negatively impact existing site geotechnical concerns.
<input type="checkbox"/> An impermeable liner or other hydraulic restriction layer is included if site constraints indicate that infiltration or lateral flows should not be allowed.	Lining prevents storm water from impacting groundwater and/or sensitive environmental or geotechnical features. Incidental infiltration, when allowable, can aid in pollutant removal and groundwater recharge.
<input type="checkbox"/> Contributing tributary area is large (typically ≥ 10 acres).	Dry extended detention basins require significant space and are more cost-effective for treating larger drainage areas.
<input type="checkbox"/> Longitudinal basin bottom slope is 0 - 2%.	Flatter slopes promote ponding and settling of particles.
<input type="checkbox"/> Basin length to width ratio is $\geq 2:1$ (L:W).	A larger length to width ratio provides a longer flow path to promote settling.
<input type="checkbox"/> Forebay is included that encompasses 20 - 30% of the basin volume.	A forebay to trap sediment can decrease frequency of required maintenance.

<i>Siting and Design</i>	<i>Intent/Rationale</i>
<input type="checkbox"/> Side slopes are $\geq 3H:1V$.	Gentler side slopes are safer, less prone to erosion, able to establish vegetation more quickly and easier to maintain.
<input type="checkbox"/> Surface ponding drawdown time is between 24 and 96 hours.	Minimum drawdown time of 24 hours allows for adequate settling time and maximizes pollutant removal. Maximum drawdown time of 96 hours provides vector control.
<input type="checkbox"/> Minimum freeboard provided is ≥ 1 foot for offline facilities and ≥ 2 feet for online facilities.	Freeboard provides room for head over overflow structures and minimizes risk of uncontrolled surface discharge.
<input type="checkbox"/> Inflow and outflow structures are accessible by required equipment (e.g., vector truck) for inspection and maintenance.	Maintenance will prevent clogging and ensure proper operation of the flow control structures.
<input type="checkbox"/> A low flow channel or trench with a $\geq 2\%$ slope is provided. A gravel infiltration trench is provided where infiltration is allowable.	Aids in draining or infiltrating dry weather flows.
<input type="checkbox"/> Overflow is safely conveyed to a downstream storm drain system or discharge point. Size overflow structure to pass 100-year peak flow.	Planning for overflow lessens the risk of property damage due to flooding.
<input type="checkbox"/> The maximum rate at which runoff is discharged is set below the erosive threshold for the site.	Extended low flows can have erosive effects.

Conceptual Design and Sizing Approach for Storm Water Pollutant Control Only

To design dry extended detention basins for storm water pollutant control only (no flow control required), the following steps should be taken:

1. Verify that siting and criteria have been met, including placement requirements, contributing tributary area, forebay volume, and maximum slopes for basin sides and bottom.
2. Calculate the DCV per Appendix B based on expected site design runoff for tributary areas.
3. Use the sizing worksheet to determine flow-through treatment sizing of the surface ponding of the dry extended detention basin, which includes calculations for a maximum 96-hour drawdown time.

Conceptual Design and Sizing Approach when Storm Water Flow Control is Applicable

Control of flow rates and/or durations will typically require significant surface ponding volume, and therefore the following steps should be taken prior to determination of storm water pollutant control design. Pre-development and allowable post-project flow rates and durations should be determined as discussed in Chapter 6 of the manual.

1. Verify that siting and criteria have been met, including placement requirements, tributary area, and maximum slopes for basin sides and bottom.
2. Iteratively determine the surface ponding required to provide detention storage to reduce flow rates and durations to allowable limits. Flow rates and durations can be controlled from detention storage by altering outlet structure orifice size(s) and/or water control levels. Multi-level orifices can be used within an outlet structure to control the full range of flows.
3. If a dry extended detention basin cannot fully provide the flow rate and duration control required by this manual, an upstream or downstream structure with appropriate storage volume such as an additional basin or underground vault can be used to provide remaining controls.
4. After the dry extended detention basin has been designed to meet flow control requirements, calculations must be completed to verify if storm water pollutant control requirements to treat the DCV have been met.

E.19 FT-5 Proprietary Flow-Through Treatment Control BMPs

The purpose of this fact sheet is to help explain the potential role of proprietary BMPs in meeting flow through treatment control BMP requirements. The fact sheet does not describe design criteria like the other fact sheets in this appendix because this information varies by BMP product model.

Note that the City of Vista does not have an alternative compliance program, so flow through treatment control BMPs should only be used for pre-treatment as of the implementation date of this Manual. ***Criteria for Use of a Proprietary BMP as a Flow-Through Treatment Control BMP***

A proprietary BMP may be acceptable as a “flow-through treatment control BMP” under the following conditions:

- (1) The BMP is selected and sized consistent with the method and criteria described in Appendix B.6;
- (2) The BMP is designed and maintained in a manner consistent with its performance certifications (See explanation in Appendix B.6); and
- (3) The BMP is acceptable at the discretion of the City Engineer. The City Engineer has no obligation to accept any proprietary flow-through treatment control BMP. In determining the acceptability of a BMP, the City Engineer should consider, as applicable, (a) the data submitted; (b) representativeness of the data submitted; (c) consistency of the BMP performance claims with pollutant control objectives; certainty of the BMP performance claims; (d) for projects within the public right of way and/or public projects: maintenance requirements, cost of maintenance activities, relevant previous local experience with operation and maintenance of the BMP type, ability to continue to operate the system in event that the vending company is no longer operating as a business; and (e) other relevant factors.

Guidance for Sizing Proprietary BMPs

Proprietary flow-through BMPs must meet the same sizing guidance as other flow-through treatment control BMPs. Guidance for sizing flow-through BMPs to comply with requirements of this manual is provided in Appendix B.6.

E.20 PL Plant List

Plant Name		Irrigation Requirements		Preferred Location in Basin		Applicable Bioretention Sections (Un-Lined Facilities)				Applicability to Flow-Through Planter? (Lined Facility)	
Latin Name	Common Name	Temporary Irrigation during Plant Establishment Period	Permanent Irrigation (Drip / Spray) ⁽¹⁾	Basin Bottom	Basin Side Slopes	Section A Treatment-Only Bioretention in Hydrologic Soil Group A or B Soils	Section B Treatment-Only Bioretention in Hydrologic Soil Group C or D soils	Section C Treatment Plus Flow Control Bioretention in Hydrologic Soil Group A or B Soils	Section D Treatment Plus Flow Control Bioretention in Hydrologic Soil Group C or D Soils	NO Applicable to Un-lined Facilities Only (Bioretention Only)	YES Can Use in Lined or Un-Lined Facility (Flow-Through Planter OR Bioretention)
TREES⁽²⁾											
Alnus rhombifolia	White Alder	X		X	X	X	X	X	X	X	
Platanus racemosa	California Sycamore	X		X	X	X	X	X	X	X	
Salix lasiolepis	Arroyo Willow	X			X	X	X	X	X	X	
Salix lucida	Lance-Leaf Willow	X			X	X	X	X	X	X	
Sambucus mexicana	Blue Elderberry	X			X	X	X	X	X	X	
SHRUBS / GROUNDCOVER											
Achillea millefolium	Yarrow	X			X	X	X				X
Agrostis palens	Thingrass	X			X	X	X	X	X		X
Anemopsis californica	Yerba Manza	X			X	X	X	X	X		X
Baccharis douglasii	Marsh Baccahris	X	X	X		X	X	X	X		X
Carex praegracillis	California Field Sedge	X	X	X		X	X	X	X		X
Carex spissa	San Diego Sedge	X	X	X		X	X	X	X		X
Carex subfusca	Rusty Sedge	X	X	X	X	X	X	X	X		X
Distichlis spicata	Salt Grass	X	X	X		X	X	X	X		X
Eleocharis macrostachya	Pale Spike Rush	X	X	X		X	X	X	X		X
Festuca rubra	Red Fescue	X	X	X	X	X	X				X
Festuca californica	California Fescue	X	X		X	X	X				X
Iva hayesiana	Hayes Iva	X			X	X	X				X
Juncus Mexicana	Mexican Rush	X	X	X	X	X	X	X	X		X
Jucus patens	California Gray Rush	X	X	X	X	X	X	X	X		X
Leymus condensatus 'Canyon Prince'	Canyon Prince Wild Rye	X	X	X	X	X	X	X	X		X
Mahonia nevinii	Nevin's Barberry	X			X	X	X	X	X		X
Muhlenburgia rigens	Deergrass	X	X	X	X	X	X	X	X		X
Mimulus cardinalis	Scarlet Monkeyflower	X		X	X	X	X				X
Ribes speciosum	Fushia Flowering Goose.	X			X	X	X				X
Rosa californica	California Wild Rose	X	X		X	X	X				X
Scirpus cenusus	Low Bullrush	X	X	X		X	X	X	X		X
Sisyrinchium bellum	Blue-eyed Grass	X			X	X	X				X

1. All plants will benefit from some supplemental irrigation during hot dry summer months, particularly those on basin side slopes and further inland.
2. All trees should be planted a min. of 10' away from any drain pipes or structures.

Appendix

F

CITY OF VISTA BMP DESIGN MANUAL

Biofiltration Standard and Checklist

Appendix F Biofiltration Standard and Checklist

Introduction

The MS4 Permit and this manual define a specific category of storm water pollutant treatment BMPs called “biofiltration BMPs.” The MS4 Permit (Section E.3.c.1) states:

Biofiltration BMPs must be designed to have an appropriate hydraulic loading rate to maximize storm water retention and pollutant removal, as well as to prevent erosion, scour, and channeling within the BMP, and must be sized to:

- a) **Treat 1.5 times the DCV not reliably retained onsite, OR**
- b) **Treat the DCV not reliably retained onsite with a flow-through design that has a total volume, including pore spaces and pre-filter detention volume, sized to hold at least 0.75 times the portion of the DCV not reliably retained onsite.**

A project applicant must be able to affirmatively demonstrate that a given BMP is designed and sized in a manner consistent with this definition to be considered as a “biofiltration BMP” as part of a compliant storm water management plan. Retention is defined in the MS4 Permit as evapotranspiration, infiltration, and harvest and use of storm water vs. discharge to a surface water system.

Contents and Intended Uses

This appendix contains a checklist of the key underlying criteria that must be met for a BMP to be considered a biofiltration BMP. The purpose of this checklist is to facilitate consistent review and approval of biofiltration BMPs that meet the “biofiltration standard” defined by the MS4 Permit.

This checklist includes specific design criteria that are essential to defining a system as a biofiltration BMP; however it does not present a complete design basis. This checklist was used to develop BMP Fact Sheets for PR-1 biofiltration with partial retention and BF-1 biofiltration, which do present a complete design basis. Therefore, biofiltration BMPs that substantially meet all aspects of the Fact sheets PR-1 or BF-1 should be able to complete this checklist without additional documentation beyond what would already be required for a project submittal.

Appendix F: Biofiltration Standard and Checklist

Other biofiltration BMP designs⁸ (including both non-proprietary and proprietary designs) may also meet the underlying MS4 Permit requirements to be considered biofiltration BMPs. These BMPs may be classified as biofiltration BMPs if they (1) meet the minimum design criteria listed in this appendix, including the pollutant treatment performance standard in Appendix F.1, (2) are designed and maintained in a manner consistent with their performance certifications (See explanation in Appendix F.2), if applicable, and (3) are acceptable at the discretion of the City Engineer. The applicant may be required to provide additional studies and/or required to meet additional design criteria beyond the scope of this document in order to demonstrate that these criteria are met.

Organization

The checklist in this appendix is organized into the seven (7) main objectives associated with biofiltration BMP design. It describes the associated minimum criteria that must be met in order to qualify a biofiltration BMP as meeting the biofiltration standard. The seven main objectives are listed below. Specific design criteria and associated manual references associated with each of these objectives is provided in the checklist in the following section.

1. Biofiltration BMPs shall be allowed only as described in the BMP selection process in this manual (i.e., retention feasibility hierarchy).
2. Biofiltration BMPs must be sized using acceptable sizing methods described in this manual.
3. Biofiltration BMPs must be sited and designed to achieve maximum feasible infiltration and evapotranspiration.
4. Biofiltration BMPs must be designed with a hydraulic loading rate to maximize pollutant retention, preserve pollutant control/sequestration processes, and minimize potential for pollutant washout.
5. Biofiltration BMPs must be designed to promote appropriate biological activity to support and maintain treatment processes.
6. Biofiltration BMPs must be designed to prevent erosion, scour, and channeling within the BMP.
7. Biofiltration BMP must include operations and maintenance design features and planning

⁸ Defined as biofiltration designs that do not conform to the specific design criteria described in Fact Sheets PR-1 or BF-1. This category includes proprietary BMPs that are sold by a vendor as well as non-proprietary BMPs that are designed and constructed of primarily of more elementary construction materials.

considerations to provide for continued effectiveness of pollutant and flow control functions.

Biofiltration Criteria Checklist

The applicant shall provide documentation of compliance with each criterion in this checklist as part of the project submittal. The right column of this checklist identifies the submittal information that is recommended to document compliance with each criterion. Biofiltration BMPs that substantially meet all aspects of Fact Sheets PR-1 or BF-1 should still use this checklist; however additional documentation (beyond what is already required for project submittal) should not be required.

1. Biofiltration BMPs shall be allowed to be used only as described in the BMP selection process based on a documented feasibility analysis.

Intent: This manual defines a specific prioritization of pollutant treatment BMPs, where BMPs that retain water (retained includes evapotranspired, infiltrated, and/or harvested and used) must be used before considering BMPs that have a biofiltered discharge to the MS4 or surface waters. Use of a biofiltration BMP in a manner in conflict with this prioritization (i.e., without a feasibility analysis justifying its use) is not permitted, regardless of the adequacy of the sizing and design of the system.

-
- | | | |
|--------------------------|-----------------------------------------------------------------------------------------------------------|---------------------------------------------------------------------------------|
| <input type="checkbox"/> | The project applicant has demonstrated that it is not technically feasible to retain the full DCV onsite. | Document feasibility analysis and findings in project submittal per Appendix C. |
|--------------------------|-----------------------------------------------------------------------------------------------------------|---------------------------------------------------------------------------------|

2. Biofiltration BMPs must be sized using acceptable sizing methods.

Intent: The MS4 Permit and this manual defines specific sizing methods that must be used to size biofiltration BMPs. Sizing of biofiltration BMPs is a fundamental factor in the amount of storm water that can be treated and also influences volume and pollutant retention processes.

-
- | | | |
|--------------------------|--------------------------------------------------------------------------------------------------------------------------------------------------|-------------------------------------------------------------------------------------------------|
| <input type="checkbox"/> | The project applicant has demonstrated that biofiltration BMPs are sized to meet one of the biofiltration sizing options available (Appendix B). | Submit sizing worksheets (Appendix B) or other equivalent documentation with project submittal. |
|--------------------------|--------------------------------------------------------------------------------------------------------------------------------------------------|-------------------------------------------------------------------------------------------------|

3. Biofiltration BMPs must be sited and designed to achieve maximum feasible infiltration and evapotranspiration.

Intent: Various decisions about BMP placement and design influence how much water is retained via infiltration and evapotranspiration. The MS4 Permit requires that biofiltration BMPs achieve maximum feasible retention (evapotranspiration and infiltration) of storm water volume.

Appendix F: Biofiltration Standard and Checklist

<input type="checkbox"/>	The biofiltration BMP is sited to allow for maximum infiltration of runoff volume based on the feasibility factors considered in site planning efforts. It is also designed to maximize evapotranspiration through the use of amended media and plants (biofiltration designs without amended media and plants may be permissible; see Item 5).	Document site planning and feasibility analyses in project submittal per Section 5.4.
<input type="checkbox"/>	For biofiltration BMPs categorized as “Partial Infiltration Condition,” the infiltration storage depth in the biofiltration design has been selected to drain in 36 hours (+/-25%) or an alternative value shown to maximize infiltration on the site.	Included documentation of estimated infiltration rate per Appendix D; provide calculations using Appendix B.4 and B.5 to show that the infiltration storage depth meets this criterion. Note, depths that are too shallow or too deep may not be acceptable.
<input type="checkbox"/>	For biofiltration BMP locations categorized as “Partial Infiltration Condition,” the infiltration storage is over the entire bottom of the biofiltration BMP footprint.	Document on plans that the infiltration storage covers the entire bottom of the BMP (i.e., not just underdrain trenches); or an equivalent footprint elsewhere on the site.
<input type="checkbox"/>	For biofiltration BMP locations categorized as “Partial Infiltration Condition,” the sizing factor used for the infiltration storage area is not less than the minimum biofiltration BMP sizing factors shown in Appendix B.5.1.	Provide a table that compares the minimum sizing factor per Appendix B.5.1 to the provided sizing factor. Note: The infiltration storage area could be a separate storage feature located downstream of the biofiltration BMP, not necessarily within the same footprint.
<input type="checkbox"/>	An impermeable liner or other hydraulic restriction layer is only used when needed to avoid geotechnical and/or subsurface contamination issues in locations identified as “Infiltration Not Feasible.”	If using an impermeable liner or hydraulic restriction layer, provide documentation of feasibility findings per Appendix C that recommend the use of this feature.
<input type="checkbox"/>	The use of “compact” biofiltration BMP design ⁹ is permitted only in conditions identified as “Infiltration Not Feasible” and where site-specific documentation demonstrates that the use of larger footprint biofiltration BMPs would be infeasible.	Provide documentation of feasibility findings that recommend no infiltration is feasible. Provide site-specific information to demonstrate that a larger footprint biofiltration BMP would not be feasible.

⁹ Compact biofiltration BMPs are defined as features with infiltration storage footprint less than the minimum sizing factors in Appendix B.5.1. Note that if a biofiltration BMP is accompanied by an infiltrating area

4. Biofiltration BMPs must be designed with a hydraulic loading rate to maximize pollutant retention, preserve pollutant control processes, and minimize potential for pollutant washout.

Intent: Various decisions about biofiltration BMP design influence the degree to which pollutants are retained. The MS4 Permit requires that biofiltration BMPs achieve maximum feasible retention of storm water pollutants.

<input type="checkbox"/>	Media selected for the biofiltration BMP meets minimum quality and material specifications per City or County LID Manual, including the maximum allowable design filtration rate and minimum thickness of media.	Provide documentation that media meets the specifications in City or County LID Manual.
OR		
<input type="checkbox"/>	Alternatively, for proprietary designs and custom media mixes not meeting the media specifications contained in the City or County LID Manual, field scale testing data are provided to demonstrate that proposed media meets the pollutant treatment performance criteria in Section F.1 below.	Provide documentation of performance information as described in Section F.1.
<input type="checkbox"/>	To the extent practicable, filtration rates are outlet controlled (e.g., via an underdrain and orifice/weir) instead of controlled by the infiltration rate of the media.	Include outlet control in designs or provide documentation of why outlet control is not practicable.
<input type="checkbox"/>	The water surface drains to at least 12 inches below the media surface within 24 hours from the end of storm event flow to preserve plant health and promote healthy soil structure.	Include calculations to demonstrate that drawdown rate is adequate.
<input type="checkbox"/>	If nutrients are a pollutant of concern, design of the biofiltration BMP follows nutrient-sensitive design criteria.	Follow specifications for nutrient sensitive design in Fact Sheet BF-2. Or provide alternative documentation that nutrient treatment is addressed and potential for nutrient release is minimized.

downstream that has a footprint equal to at least the minimum sizing factors in Appendix B.5.1, then it is not considered to be a compact biofiltration BMP for the purpose of Item 4 of the checklist. For potential configurations with a higher rate biofiltration BMP upstream of a larger footprint infiltration area, the BMP would still need to comply with Item 5 of this checklist for pollutant treatment effectiveness.

Appendix F: Biofiltration Standard and Checklist

<input type="checkbox"/>	Media gradation calculations or geotextile selection calculations demonstrate that migration of media between layers will be prevented and permeability will be preserved.	Follow specification for choking layer or geotextile in Fact Sheet PR-1 or BF-1. Or include calculations to demonstrate that choking layer is appropriately specified.
5. Biofiltration BMPs must be designed to promote appropriate biological activity to support and maintain treatment processes.		
Intent: Biological processes are an important element of biofiltration performance and longevity.		
<input type="checkbox"/>	Plants have been selected to be tolerant of project climate, design ponding depths and the treatment media composition.	Provide documentation justifying plant selection. Refer to the plant list in Appendix E.20.
<input type="checkbox"/>	Plants have been selected to minimize irrigation requirements.	Provide documentation describing irrigation requirements for establishment and long term operation.
<input type="checkbox"/>	Plant location and growth will not impede expected long-term media filtration rates and will enhance long term infiltration rates to the extent possible.	Provide documentation justifying plant selection. Refer to the plant list in Appendix E.20.
<input type="checkbox"/>	If plants are not applicable to the biofiltration design, other biological processes are supported as needed to sustain treatment processes (e.g., biofilm in a subsurface flow wetland).	For biofiltration designs without plants, describe the biological processes that will support effective treatment and how they will be sustained.
6. Biofiltration BMPs must be designed with a hydraulic loading rate to prevent erosion, scour, and channeling within the BMP.		
Intent: Erosion, scour, and/or channeling can disrupt treatment processes and reduce biofiltration effectiveness.		
<input type="checkbox"/>	Scour protection has been provided for both sheet flow and pipe inflows to the BMP, where needed.	Provide documentation of scour protection as described in Fact Sheets PR-1 or BF-1 or approved equivalent.
<input type="checkbox"/>	Where scour protection has not been provided, flows into and within the BMP are kept to non-erosive velocities.	Provide documentation of design checks for erosive velocities as described in Fact Sheets PR-1 or BF-1 or approved equivalent.

Appendix F: Biofiltration Standard and Checklist

- | | | |
|--------------------------|-----------------------------------------------------------------------------------------------------------------------------------------------------------------------------------------------------------------------------------------|-------------------------------------------------------------------------------------------|
| <input type="checkbox"/> | For proprietary BMPs, the BMP is used in a manner consistent with manufacturer guidelines and conditions of its third-party certification ¹⁰ (i.e., maximum tributary area, maximum inflow velocities, etc., as applicable). | Provide copy of manufacturer recommendations and conditions of third-party certification. |
|--------------------------|-----------------------------------------------------------------------------------------------------------------------------------------------------------------------------------------------------------------------------------------|-------------------------------------------------------------------------------------------|

7. Biofiltration BMP must include operations and maintenance design features and planning considerations for continued effectiveness of pollutant and flow control functions.

Intent: Biofiltration BMPs require regular maintenance in order provide ongoing function as intended. Additionally, it is not possible to foresee and avoid potential issues as part of design; therefore plans must be in place to correct issues if they arise.

- | | | |
|--------------------------|----------------------------------------------------------------------------------------------------------------------------------------------------------------------------------------------------------------------------------------------------------------|----------------------------------------------------------------------------------------------------------------|
| <input type="checkbox"/> | The biofiltration BMP O&M plan describes specific inspection activities, regular/periodic maintenance activities and specific corrective actions relating to scour, erosion, channeling, media clogging, vegetation health, and inflow and outflow structures. | Include O&M plan with project submittal as described in Chapter 7. |
| <input type="checkbox"/> | Adequate site area and features have been provided for BMP inspection and maintenance access. | Illustrate maintenance access routes, setbacks, maintenance features as needed on project water quality plans. |
| <input type="checkbox"/> | For proprietary biofiltration BMPs, the BMP maintenance plan is consistent with manufacturer guidelines and conditions of its third-party certification (i.e., maintenance activities, frequencies). | Provide copy of manufacturer recommendations and conditions of third-party certification. |

¹⁰ Certifications or verifications issued by the Washington Technology Acceptance Protocol-Ecology program and the New Jersey Corporation for Advanced Technology programs are typically accompanied by a set of guidelines regarding appropriate design and maintenance conditions that would be consistent with the certification/verification

F.1 Pollutant Treatment Performance Standard

Standard biofiltration BMPs that are designed following the criteria in Fact Sheets PR-1 and BF-1 are presumed to meet the pollutant treatment performance standard associated with biofiltration BMPs. This presumption is based on the MS4 Permit Fact Sheet which cites analyses of standard biofiltration BMPs conducted in the Ventura County Technical Guidance Manual (July 2011).

For BMPs that do not meet the biofiltration media specification and/or the range of acceptable media filtration rates described in Fact Sheet, PR-1 and BF-1, additional documentation must be provided to demonstrate that adequate pollutant treatment performance is provided to be considered a biofiltration BMP. Project applicants have three options for documenting compliance:

- 1) Project applicants may provide documentation to substantiate that the minor modifications to the design is expected to provide equal or better pollutant removal performance for the project pollutants of concern than would be provided by a biofiltration design that complies with the criteria in Fact Sheets PR-1 and BF-1. Minor modifications are design elements that deviate only slightly from standard design criteria and are expected to either not impact performance or to improve performance compared to standard biofiltration designs. The reviewing agency has the discretion to accept or reject this documentation and/or request additional documentation to substantiate equivalent or better performance to BF-1 or PR-1, as applicable. Examples of minor deviations include:
 - Different particle size distribution of aggregate, with documentation that system filtration rate will meet specifications.
 - Alternative source of organic components, with documentation of material suitability and stability from appropriate testing agency.
 - Specialized amendments to provide additional treatment mechanisms, and which have negligible potential to upset other treatment mechanisms or otherwise deteriorate performances.
- 2) For proprietary BMPs, project applicants may provide evidence that the BMP has been certified for use as part of the Washington State Technology Assessment Protocol-Ecology certification program and meets each of the following requirements:
 - a. The applicant must demonstrate (using the checklist in this Appendix) that the BMP meets all other conditions to be considered as a biofiltration BMP. For example, a cartridge media filter or hydrodynamic separator would not meet biofiltration BMP design criteria regardless of Technology Acceptance Protocol-Ecology certification because they do not support effective biological processes.

Appendix F: Biofiltration Standard and Checklist

- b. The applicant must select BMPs that have an active Technology Acceptance Protocol-Ecology certification, with General Use Level Designation for the appropriate project pollutants of concern as identified in Table F.1-1. The list of certified technologies is updated as new technologies are approved (link below). Technologies with Pilot Use Level Designation and Conditional Use Level Designations are not acceptable. Refer to:

<http://www.ecy.wa.gov/programs/wq/stormwater/newtech/technologies.html>.
 - c. The applicant must demonstrate that BMP is being used in a manner consistent with all conditions of the Technology Acceptance Protocol-Ecology certification while meeting the flow rate or volume design criteria that is required for biofiltration BMPs under this manual. Conditions of Technology Acceptance Protocol-Ecology certification are available by clicking on the technology name at the website listed in bullet b. Additional discussion about sizing of proprietary biofiltration BMPs to comply with applicable sizing standards is provided below in Section F.2. For projects within the public right of way and/or public projects: the product must be acceptable to the City Engineer with respect to maintainability and long term operation of the product. In determining the acceptability of a product the City Engineer should consider, as applicable, maintenance requirements, cost of maintenance activities, relevant previous local experience with operation and maintenance of the BMP type, ability to continue to operate the system in event that the vending company is no longer operating as a business, and other relevant factors.
- 3) For BMPs that do not fall into options 1 or 2 above, the City Engineer may allow the applicant to submit alternative third-party documentation that the pollutant treatment performance of the system is consistent with the performance levels associated with the necessary Technology Acceptance Protocol-Ecology certifications. Table F.1-1 describes the required levels of certification and Table F.1-2 describes the pollutant treatment performance levels associated with each level of certification. Acceptance of this approach is at the sole discretion of the City Engineer. If Technology Acceptance Protocol-Ecology certifications are not available, preference shall be given to:
- a. Verified third-party, field-scale testing performance under the Technology Acceptance Reciprocity Partnership Tier II Protocol. This protocol is no longer operated, however this is considered to be a valid protocol and historic verifications are considered to be representative provided that product models being proposed are consistent with those that were tested. Technology Acceptance Reciprocity Partnership verifications were conducted under New Jersey Corporation for Advance Testing and are archived at the website linked below. Note that Technology Acceptance Reciprocity Partnership verifications must be matched to pollutant treatment standards in Table F.1-2 then

Appendix F: Biofiltration Standard and Checklist

matched to an equivalent Technology Acceptance Protocol-Ecology certification in Table F.1-1.

- b. Verified third-party, field-scale testing performance under the New Jersey Corporation for Advance Testing protocol. Note that New Jersey Corporation for Advance Testing verifications must be matched to pollutant treatment standards in Table F.1-2 then matched to an equivalent Technology Acceptance Protocol-Ecology certification in Table F.1-1.

A list of field-scale verified technologies under Technology Acceptance Reciprocity Partnership Tier II and New Jersey Corporation for Advance Testing can be accessed at: <http://www.njcat.org/verification-process/technology-verification-database.html> (refer to field verified technologies only).

Table F.1-1: Required Technology Acceptance Protocol-Ecology Certifications for Pollutants of Concern for Biofiltration Performance Standard

Project Pollutant of Concern	Required Technology Acceptance Protocol-Ecology Certification for Biofiltration Performance Standard
Trash	Basic Treatment, or Phosphorus Treatment, or Enhanced Treatment
Sediments	Basic Treatment, or Phosphorus Treatment, or Enhanced Treatment
Oil and Grease	Basic Treatment, or Phosphorus Treatment, or Enhanced Treatment
Nutrients	Phosphorus Treatment ¹
Metals	Enhanced Treatment
Pesticides	Basic Treatment (including filtration) ² or Phosphorus Treatment, or Enhanced Treatment
Organics	Basic Treatment (including filtration) ² , or Phosphorus Treatment, or Enhanced Treatment
Bacteria and Viruses	Basic Treatment (including bacteria removal processes) ³ , or Phosphorus Treatment, or Enhanced Treatment

1 – There is no Technology Acceptance Protocol-Ecology equivalent for nitrogen compounds; however systems that are designed to retain phosphorus (as well as meet basic treatment designation), generally also provide treatment of nitrogen compounds. Where nitrogen is a pollutant of concern, relative performance of available certified systems for nitrogen removal should be considered in BMP selection.

Appendix F: Biofiltration Standard and Checklist

2 – Pesticides, organics, and oxygen demanding substances are typically addressed by particle filtration consistent with the level of treatment required to achieve Basic treatment certification; if a system with Basic treatment certification does not provide filtration, it is not acceptable for pesticides, organics or oxygen demanding substances.

3 – There is no Technology Acceptance Protocol-Ecology equivalent for pathogens (viruses and bacteria), and testing data are limited because of typical sample hold times. Systems with Technology Acceptance Protocol-Ecology Basic Treatment must include one or more significant bacteria removal process such as media filtration, physical sorption, predation, reduced redox conditions, and/or solar inactivation. Where design options are available to enhance pathogen removal (i.e., pathogen-specific media mix offered by vendor), this design variation should be used.

Table F.1-2: Performance Standards for Technology Acceptance Protocol-Ecology Certification

Performance Goal	Influent Range	Criteria
Basic Treatment	20 – 100 mg/L TSS	Effluent goal \leq 20 mg/L TSS
	100 – 200 mg/L TSS	\geq 80% TSS removal
	>200 mg/L TSS	> 80% TSS removal
Enhanced (Dissolved Metals) Treatment	Dissolved copper 0.005 – 0.02 mg/L	Must meet basic treatment goal and better than basic treatment currently defined as >30% dissolved copper removal
	Dissolved zinc 0.02 – 0.3 mg/L	Must meet basic treatment goal and better than basic treatment currently defined as >60% dissolved zinc removal
Phosphorous Treatment	Total phosphorous 0.1 – 0.5 mg/L	Must meet basic treatment goal and exhibit \geq 50% total phosphorous removal
Oil Treatment	Total petroleum hydrocarbon > 10 mg/L	No ongoing or recurring visible sheen in effluent Daily average effluent Total petroleum hydrocarbon concentration < 10 mg/L Maximum effluent Total petroleum hydrocarbon concentration for a 15 mg/L for a discrete (grab) sample
Pretreatment	50 – 100 mg/L TSS	\leq 50 mg/L TSS
	\geq 200 mg/L TSS	\geq 50% TSS removal

F.2 Guidance on Sizing and Design of Non-Standard Biofiltration BMPs

This section explains the general process for design and sizing of non-standard biofiltration BMPs. This section assumes that the BMPs have been selected based on the criteria in Section F.1.

F.2.1 Guidance on Design per Conditions of Certification/Verification

The biofiltration standard and checklist in this appendix requires that “the BMP is used in a manner consistent with manufacturer guidelines and conditions of its third-party certification.” Practically, what this means is that the BMP is used in the same way in which it was tested and certified. For example, it is not acceptable for a BMP of a given size to be certified/verified with a 100 gallon per minute treatment rate and be applied at a 150 gallon per minute treatment rate in a design.

Certifications or verifications issued by the Washington Technology Acceptance Protocol-Ecology program and the Technology Acceptance Reciprocity Partnership or New Jersey Corporation for Advance Testing programs are typically accompanied by a set of guidelines regarding appropriate design and maintenance conditions that would be consistent with the certification/verification. It is common for these approvals to specify the specific model of BMP, design capacity for given unit sizes, type of media that is the basis for approval, and/or other parameter. The applicant must demonstrate conclusively that the proposed application of the BMP is consistent with these criteria.

For alternate non-proprietary systems that do not have a Technology Acceptance Protocol-Ecology / Technology Acceptance Reciprocity Partnership / New Jersey Corporation for Advance Testing certification (but which still must provide quantitative data per Appendix F.1), it must be demonstrate that the configuration and design proposed for the project is reasonably consistent with the configuration and design under which the BMP was tested to demonstrate compliance with Appendix F.1.

F.2.2 Sizing of Flow-Based Biofiltration BMP

This sizing method is only available when the BMP meets the pollutant treatment performance standard in Appendix F.1.

Proprietary biofiltration BMPs are typically designed as a flow-based BMPs (i.e., a constant treatment capacity with negligible storage volume). Additionally, proprietary biofiltration is only acceptable if no infiltration is feasible and where site-specific documentation demonstrates that the use of larger footprint biofiltration BMPs would be infeasible or if the proprietary biofiltration BMP is supplemented with a downstream retention BMP that achieves volume reduction equivalent to a non-proprietary BMP sized in accordance with Worksheet B.5-1.. The applicable sizing method for biofiltration is therefore reduced to: Treat 1.5 times the DCV.

The following steps should be followed to demonstrate that the system is sized to treat 1.5 times the

Appendix F: Biofiltration Standard and Checklist

DCV.

1. Calculate the flow rate required to meet the pollutant treatment performance standard without scaling for the 1.5 factor. Options include either:
 - Calculate the runoff flow rate from a 0.2 inch per hour uniform intensity precipitation event (See methodology Appendix B.6.3), or
 - Conduct a continuous simulation analysis to compute the size required to capture and treat 80 percent of average annual runoff; for small catchments, 5-minute precipitation data should be used to account for short time of concentration. Nearest rain gage with 5-minute precipitation data is allowed for this analysis.
2. Multiply the flow rate from Step 1 by 1.5 to compute the design flow rate for the biofiltration system.
3. Based on the conditions of certification/verification (discussed above), establish the design capacity, as a flow rate, of a given sized unit.
4. Demonstrates that an appropriate unit size and number of units is provided to provide a flow rate that meets the required flow rate from Step 2.
5. Provide a downstream retention BMP that achieves volume reduction equivalent to a non-proprietary BMP sized in accordance with Worksheet B.5-1.

Appendix

G

CITY OF VISTA BMP DESIGN MANUAL

**Guidance for Continuous
Simulation and Hydromodification
Management Sizing Factors**

February 2016

Appendix G Guidance for Continuous Simulation and Hydromodification Management Sizing Factors

G.1 Guidance for Continuous Simulation Hydrologic Modeling for Hydromodification Management Studies in San Diego County Region 9

G.1.1 Introduction

Continuous simulation hydrologic modeling is used to demonstrate compliance with the performance standards for hydromodification management in San Diego. There are several available hydrologic models that can perform continuous simulation analyses. Each has different methods and parameters for determining the amount of rainfall that becomes runoff, and for representing the hydraulic operations of certain structural BMPs such as biofiltration with partial retention or biofiltration. This Appendix is intended to:

- Identify acceptable models for continuous simulation hydrologic analyses for hydromodification management;
- Provide guidance for selecting climatology input to the models;
- Provide standards for rainfall loss parameters to be used in the models;
- Provide standards for defining physical characteristics of LID components; and
- Provide guidance for demonstrating compliance with performance standards for hydromodification management.

This Appendix is not a user's manual for any of the acceptable models, nor a comprehensive manual for preparing a hydrologic model. This Appendix provides guidance for selecting model input parameters for the specific purpose of hydromodification management studies. The model preparer must be familiar with the user's manual for the selected software to determine how the parameters are entered to the model.

G.1.2 Software for Continuous Simulation Hydrologic Modeling

The following software models may be used for hydromodification management studies in San Diego:

- HSPF – Hydrologic Simulation Program-FORTRAN, distributed by USEPA, public domain.
- SDHM – San Diego Hydrology Model, distributed by Clear Creek Solutions, Inc. This is an HSPF-based model with a proprietary interface that has been customized for use in San Diego for hydromodification management studies.
- SWMM – Storm Water Management Model, distributed by USEPA, public domain.

Third-party and proprietary software, such as XPSWMM or PCSWMM, may be used for hydromodification management studies in San Diego, provided that:

- Input and output data from the software can interface with public domain software such as SWMM. In other words, input files from the third party software should have sufficient functionality to allow export to public domain software for independent validation.
- The software's hydromodification control processes are substantiated.

G.1.3 Climatology Parameters

G.1.3.1 Rainfall

In all software applications for preparation of hydromodification management studies in San Diego, rainfall data must be selected from approved data sets that have been prepared for this purpose. As part of the development of the March 2011 Final HMP, long-term hourly rainfall records were prepared for public use. The rainfall record files are provided on the Project Clean Water website. The rainfall station map is provided in the March 2011 Final HMP and is included in this Appendix as Figure G.1-1.

Appendix G: Guidance for Continuous Simulation and Hydromodification Management Sizing Factors

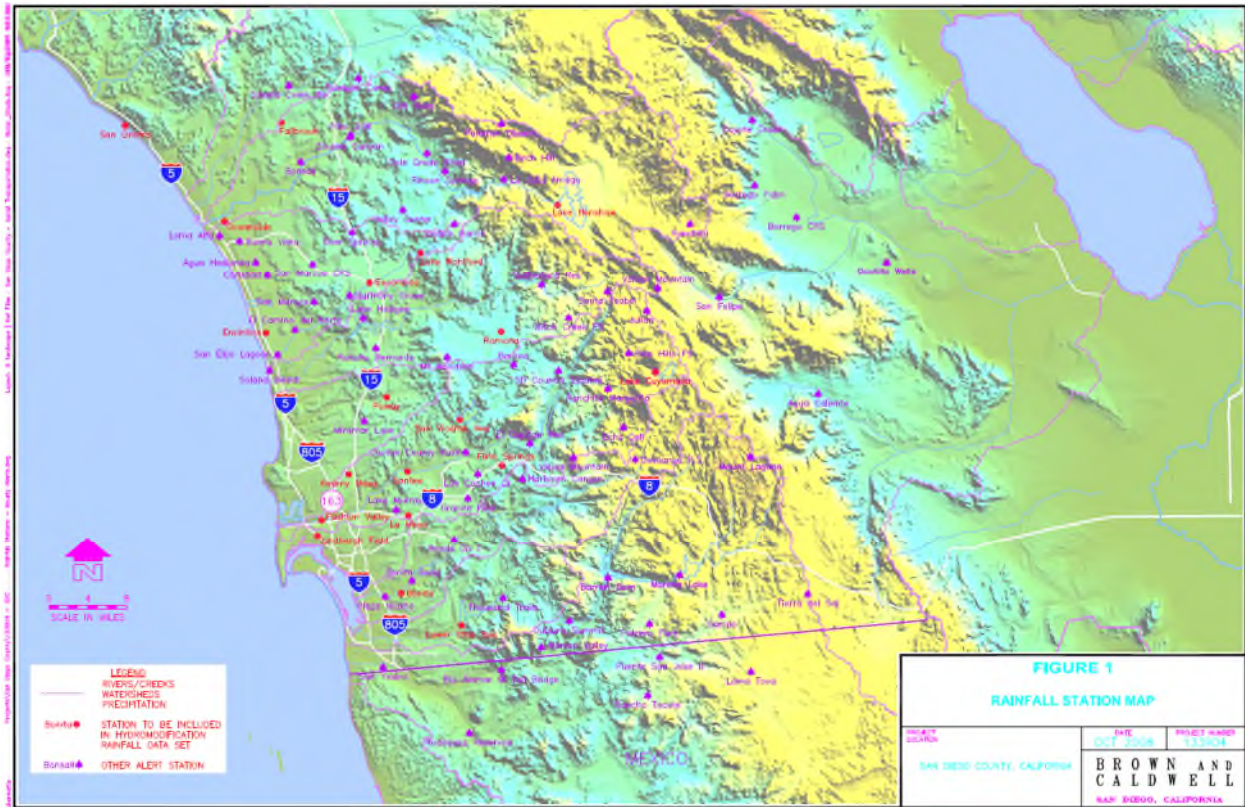

Figure G.1-1: Rainfall Station Map

Project applicants preparing continuous simulation models shall select the most appropriate rainfall data set from the rainfall record files provided on the Project Clean Water website. For a given project location, the following factors should be considered in the selection of the appropriate rainfall data set:

- In most cases, the rainfall data set in closest proximity to the project site will be the appropriate choice (refer to the rainfall station map).
- In some cases, the rainfall data set in closest proximity to the project site may not be the most applicable data set. Such a scenario could involve a data set with an elevation significantly different from the project site. In addition to a simple elevation comparison, the project proponent may also consult with the San Diego County’s average annual precipitation isopluvial map, which is provided in the San Diego County Hydrology Manual (2003). Review of this map could provide an initial estimate as to whether the project site is in a similar rainfall zone as compared to the rainfall stations. Generally, precipitation totals in San Diego County increase with increasing elevation.
- Where possible, rainfall data sets should be chosen so that the data set and the project location are both located in the same topographic zone (coastal, foothill, mountain) and major

Appendix G: Guidance for Continuous Simulation and Hydromodification Management Sizing Factors

watershed unit (Upper San Luis Rey, Lower San Luis Rey, Upper San Diego River, Lower San Diego River, etc.).

For SDHM users, the approved rainfall data sets are pre-loaded into the software package. SDHM users may select the appropriate rainfall gage within the SDHM program. HSPF or SWMM users shall download the appropriate rainfall record from the Project Clean Water website and load it into the software program.

Both the pre-development and post-project model simulation period shall encompass the entire rainfall record provided in the approved rainfall data set. Scaling the rainfall data is not permitted.

G.1.3.2 Potential Evapotranspiration

Project applicants preparing continuous simulation models shall select a data set from the sources described below to represent potential evapotranspiration.

For HSPF users, this parameter may be entered as an hourly time series. The hourly time series that was used to develop the BMP Sizing Calculator parameters is provided on the project clean water website and may be used for hydromodification management studies in San Diego. For SDHM users, the hourly evaporation data set is pre-loaded into the program. HSPF users may download the evaporation record from the Project Clean Water website and load it into the software program.

For HSPF or SWMM users, this parameter may be entered as monthly values in inches per month or inches per day. Monthly values may be obtained from the California Irrigation Management Information System "Reference Evapotranspiration Zones" brochure and map (herein "CIMIS ETo Zone Map"), prepared by California Department of Water Resources, dated January 2012. The CIMIS ETo Zone Map is available from www.cimis.gov, and is provided in this Appendix as Figure G.1-2. Determine the appropriate reference evapotranspiration zone for the project from the CIMIS ETo Zone Map. The monthly average reference evapotranspiration values are provided below in Table G.1-1.

Appendix G: Guidance for Continuous Simulation and Hydromodification Management Sizing Factors

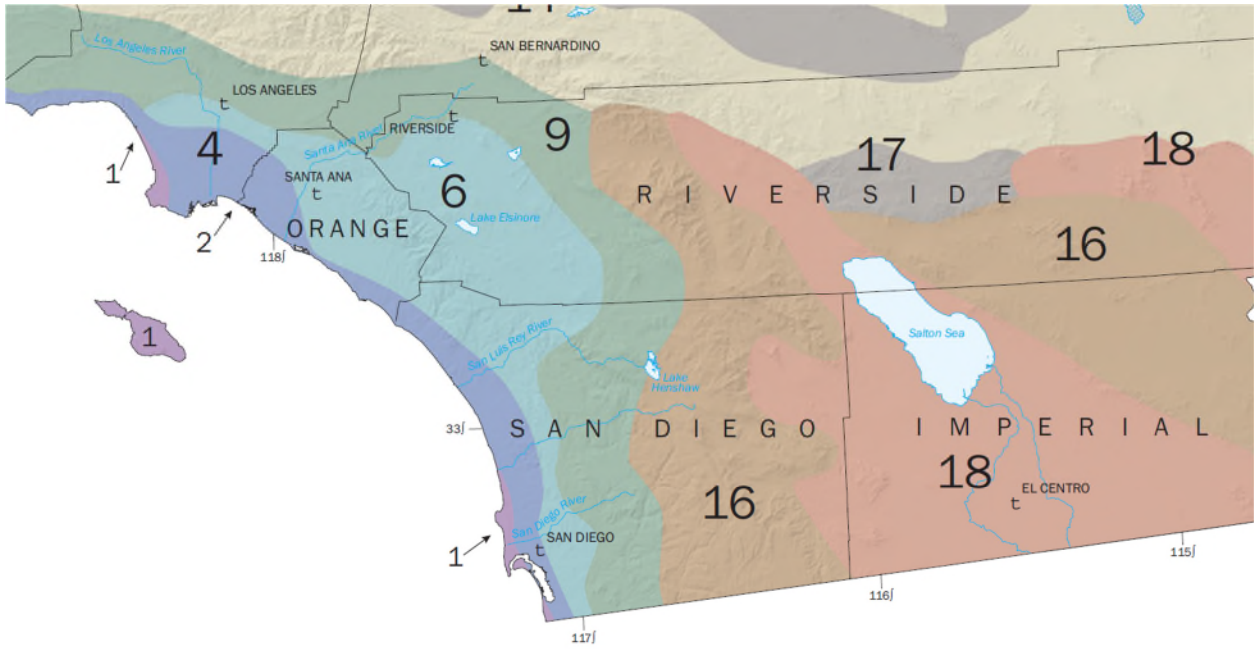

Figure G.1-2: California Irrigation Management Information System "Reference Evapotranspiration Zones"

Appendix G: Guidance for Continuous Simulation and Hydromodification Management Sizing Factors

**Table G.1-1: Monthly Average Reference Evapotranspiration by ETo Zone
(inches/month and inches/day) for use in SWMM Models for Hydromodification Management Studies in San Diego County
CIMIS Zones 1, 4, 6, 9, and 16 (See CIMIS ETo Zone Map)**

	January	February	March	April	May	June	July	August	September	October	November	December
Zone	in/month	in/month	in/month	in/month	in/month	in/month	in/month	in/month	in/month	in/month	in/month	in/month
1	0.93	1.4	2.48	3.3	4.03	4.5	4.65	4.03	3.3	2.48	1.2	0.62
4	1.86	2.24	3.41	4.5	5.27	5.7	5.89	5.58	4.5	3.41	2.4	1.86
6	1.86	2.24	3.41	4.8	5.58	6.3	6.51	6.2	4.8	3.72	2.4	1.86
9	2.17	2.8	4.03	5.1	5.89	6.6	7.44	6.82	5.7	4.03	2.7	1.86
16	1.55	2.52	4.03	5.7	7.75	8.7	9.3	8.37	6.3	4.34	2.4	1.55
	January	February	March	April	May	June	July	August	September	October	November	December
Days	31	28	31	30	31	30	31	31	30	31	30	31
Zone	in/day	in/day	in/day	in/day	in/day	in/day	in/day	in/day	in/day	in/day	in/day	in/day
1	0.030	0.050	0.080	0.110	0.130	0.150	0.150	0.130	0.110	0.080	0.040	0.020
4	0.060	0.080	0.110	0.150	0.170	0.190	0.190	0.180	0.150	0.110	0.080	0.060
6	0.060	0.080	0.110	0.160	0.180	0.210	0.210	0.200	0.160	0.120	0.080	0.060
9	0.070	0.100	0.130	0.170	0.190	0.220	0.240	0.220	0.190	0.130	0.090	0.060
16	0.050	0.090	0.130	0.190	0.250	0.290	0.300	0.270	0.210	0.140	0.080	0.050

G.1.4 LAND CHARACTERISTICS AND LOSS PARAMETERS

In all software applications for preparation of hydromodification management studies in San Diego, rainfall loss parameters must be consistent with this Appendix unless the preparer can provide documentation to substantiate use of other parameters, subject to local jurisdiction approval. HSPF and SWMM use different processes and different sets of parameters. SDHM is based on HSPF, therefore parameters for SDHM and HSPF are presented together in Section G.1.4.1. Parameters that have been pre-loaded into SDHM may be used for other HSPF hydromodification management studies outside of SDHM. Parameters for SWMM are presented separately in Section G.1.4.2.

G.1.4.1 Rainfall Loss Parameters for HSPF and SDHM

Rainfall losses in HSPF are characterized by PERLND/PWATER parameters and IMPLND parameters, which describe processes occurring when rainfall lands on pervious lands and impervious lands, respectively. "BASINS Technical Notice 6, Estimating Hydrology and Hydraulic Parameters for HSPF," prepared by the USEPA, dated July 2000, provides details regarding these parameters and summary tables of possible ranges of these parameters. Table G.1-2, excerpted from the above-mentioned document, presents the ranges of these parameters.

For HSPF studies for hydromodification management in San Diego, PERLND/PWATER parameters and IMPLND parameters shall fall within the "possible" range provided in EPA Technical Note 6. To select specific parameters, HSPF users may use the parameters established for development of the San Diego BMP Sizing Calculator, and/or the parameters that have been established for SDHM. Parameters for the San Diego BMP Sizing Calculator and SDHM are based on research conducted specifically for HSPF modeling in San Diego.

Documentation of parameters selected for the San Diego BMP Sizing Calculator is presented in the document titled, San Diego BMP Sizing Calculator Methodology, prepared by Brown and Caldwell, dated January 2012 (herein "BMP Sizing Calculator Methodology"). The PERLND/PWATER parameters selected for development of the San Diego BMP Sizing Calculator represent a single composite pervious land cover that is representative of most pre-development conditions for sites that would commonly be managed by the BMP Sizing Calculator. The parameters shown below in Table G.1-3 are excerpted from the BMP Sizing Calculator Methodology.

Appendix G: Guidance for Continuous Simulation and Hydromodification Management Sizing Factors

Table G.1-2: HSPF PERLND/PWATER and IMPLND Parameters from EPA Technical Note 6

Name	Definition	Units	Range of Values				Function of ...	Comment
			Typical		Possible			
			Min	Max	Min	Max		
PWAT – PARM2								
FOREST	Fraction forest cover	none	0.0	0.50	0.0	0.95	Forest cover	Only impact when SNOW is active
LZSN	Lower Zone Nominal Soil Moisture Storage	inches	3.0	8.0	2.0	15.0	Soils, climate	Calibration
INFILT	Index to Infiltration Capacity	in/hr	0.01	0.25	0.001	0.50	Soils, land use	Calibration , divides surface and subsurface flow
LSUR	Length of overland flow	feet	200	500	100	700	Topography	Estimate from high resolution topo maps or GIS
SLSUR	Slope of overland flow plane	ft./ft.	0.01	0.15	0.001	0.30	Topography	Estimate from high resolution topo maps or GIS
KVARY	Variable groundwater recession	1/inches	0.0	3.0	0.0	5.0	Baseflow recession variation	Used when recession rate varies with GW levels
AGWRC	Base groundwater recession	none	0.92	0.99	0.85	0.999	Baseflow recession	Calibration
PWAT – PARM3								
PETMAX	Temp below which ET is reduced	deg. F	35.0	45.0	32.0	48.0	Climate, vegetation	Reduces ET near freezing, when SNOW is active
PETMIN	Temp below which ET is set to zero	deg. F	30.0	35.0	30.0	40.0	Climate, vegetation	Reduces ET near freezing, when SNOW is active
INFEXP	Exponent in infiltration equation	none	2.0	2.0	1.0	3.0	Soils variability	Usually default to 2.0
INFILD	Ratio of max/mean infiltration capacities	none	2.0	2.0	1.0	3.0	Soils variability	Usually default to 2.0
DEEPPFR	Fraction of GW inflow to deep recharge	none	0.0	0.20	0.0	0.50	Geology, GW recharge	Accounts for subsurface losses
BASETP	Fraction of remaining ET from baseflow	none	0.0	0.05	0.0	0.20	Riparian vegetation	Direct ET from riparian vegetation
AGWETP	Fraction of remaining ET from active GW	none	0.0	0.05	0.0	0.20	Marsh/wetlands extent	Direct ET from shallow GW
PWAT – PARM4								
CEPSC	Interception storage capacity	inches	0.03	0.20	0.01	0.40	Vegetation type/density, land use	Monthly values usually used
UZSN	Upper zone nominal soil moisture storage	inches	0.10	1.0	0.05	2.0	Surface soil conditions, land use	Accounts for near surface retention
NSUR	Manning's n (roughness) for overland flow	none	0.15	0.35	0.05	0.50	Surface conditions, residue, etc.	Monthly values often used for croplands
INTFW	Interflow inflow parameter	none	1.0	3.0	1.0	10.0	Soils, topography, land use	Calibration , based on hydrograph separation
IRC	Interflow recession parameter	none	0.5	0.70	0.30	0.85	Soils, topography, land use	Often start with a value of 0.7, and then adjust
LZETP	Lower zone ET parameter	none	0.2	0.70	0.1	0.9	Vegetation type/density, root depth	Calibration
IWAT – PARM2								
LSUR	Length of overland flow	feet	50	150	50	250	Topography, drainage system	Estimate from maps, GIS, or field survey
SLSUR	Slope of overland flow plane	ft./ft.	0.01	0.05	0.001	0.15	Topography, drainage	Estimate from maps, GIS, or field survey
NSUR	Manning's n (roughness) for overland flow	none	0.03	0.10	0.01	0.15	Impervious surface conditions	Typical range is 0.05 to 0.10 for roads/parking lots
RETSC	Retention storage capacity	inches	0.03	0.10	0.01	0.30	Impervious surface conditions	Typical range is 0.03 to 0.10 for roads/parking lots
IWAT – PARM3 (PETMAX and PETMIN, same values as shown for PWAT – PARM3)								

Appendix G: Guidance for Continuous Simulation and Hydromodification Management Sizing Factors

Table G.1-3: HSPF PERLND/PWATER Parameters from BMP Sizing Calculator Methodology

	Slope	Hydrologic Soil Group A			Hydrologic Soil Group B			Hydrologic Soil Group C			Hydrologic Soil Group D		
		5%	10%	15%	5%	10%	15%	5%	10%	15%	5%	10%	15%
PWAT_PAR M2	Units												
FOREST	None	0	0	0	0	0	0	0	0	0	0	0	0
LZSN	inches	5.2	4.8	4.5	5.0	4.7	4.4	4.8	4.5	4.2	4.8	4.5	4.2
INFILT	in/hr	0.090	0.070	0.045	0.070	0.055	0.040	0.050	0.040	0.032	0.040	0.030	0.020
LSUR	Feet	200	200	200	200	200	200	200	200	200	200	200	200
SLSUR	ft./ft.	0.05	0.1	0.15	0.05	0.1	0.15	0.05	0.1	0.15	0.05	0.1	0.15
KVARY	1/inches	3	3	3	3	3	3	3	3	3	3	3	3
AGWRC	None	0.92	0.92	0.92	0.92	0.92	0.92	0.92	0.92	0.92	0.92	0.92	0.92
PWAT_PAR M3													
PETMAX (F)	F	35	35	35	35	35	35	35	35	35	35	35	35
PETMIN (F)	F	30	30	30	30	30	30	30	30	30	30	30	30
INFEXP	None	2	2	2	2	2	2	2	2	2	2	2	2
INFILD	None	2	2	2	2	2	2	2	2	2	2	2	2
DEEPPFR	None	0.4	0.4	0.4	0.4	0.4	0.4	0.4	0.4	0.4	0.4	0.4	0.4
BASETP	None	0.05	0.05	0.05	0.05	0.05	0.05	0.05	0.05	0.05	0.05	0.05	0.05
AGEWTP	None	0.05	0.05	0.05	0.05	0.05	0.05	0.05	0.05	0.05	0.05	0.05	0.05
PWAT_PAR M4													
CEPSC	inches	0.08	0.08	0.08	0.08	0.08	0.08	0.08	0.08	0.08	0.08	0.08	0.08
UZSN	inches	0.6	0.6	0.6	0.6	0.6	0.6	0.6	0.6	0.6	0.6	0.6	0.6
NSUR	None	0.2	0.2	0.2	0.2	0.2	0.2	0.2	0.2	0.2	0.2	0.2	0.2
INTFW	None	1.5	1.5	1.5	1.5	1.5	1.5	1.5	1.5	1.5	1.5	1.5	1.5
IRC	None	0.7	0.7	0.7	0.7	0.7	0.7	0.7	0.7	0.7	0.7	0.7	0.7
LZETP	None	0.5	0.5	0.5	0.5	0.5	0.5	0.5	0.5	0.5	0.5	0.5	0.5

Appendix G: Guidance for Continuous Simulation and Hydromodification Management Sizing Factors

Parameters within SDHM are documented in "San Diego Hydrology Model User Manual," prepared by Clear Creek Solutions, Inc. (as of the development of the Manual, the current version of the SDHM User Manual is dated January 2012). Parameters established for SDHM represent "grass" (non-turf grasslands), "dirt," "gravel," and "urban" cover. The documented PERLND and IMPLND parameters for the various land covers and soil types have been pre-loaded into SDHM. SDHM users shall use the parameters that have been pre-loaded into the program without modification unless the preparer can provide documentation to substantiate use of other parameters.

G.1.4.2 Rainfall Loss Parameters for SWMM

In SWMM, rainfall loss parameters (parameters that describe processes occurring when rainfall lands on pervious lands and impervious lands) are entered in the "subcatchment" module. In addition to specifying parameters, the SWMM user must also select an infiltration model.

The SWMM Manual provides details regarding the subcatchment parameters and summary tables of possible ranges of these parameters. For SWMM studies for hydromodification management in San Diego, subcatchment parameters shall fall within the range provided in the SWMM Manual. Some of the parameters depend on the selection of the infiltration model. For consistency across the San Diego region, SWMM users shall use the Green-Ampt infiltration model for hydromodification management studies. Table G.1-4 presents SWMM subcatchment parameters for use in hydromodification management studies in the San Diego region.

Appendix G: Guidance for Continuous Simulation and Hydromodification Management Sizing Factors

Table G.1-4: Subcatchment Parameters for SWMM Studies for Hydromodification Management in San Diego

SWMM Parameter Name	Unit	Range	Use in San Diego
Name X-Coordinate Y-Coordinate Description Tag Rain Gage Outlet	N/A	N/A – project-specific	Project-specific
Area	acres (ac)	Project-specific	Project-specific
Width	feet (ft.)	Project-specific	Project-specific
% Slope	percent (%)	Project-specific	Project-specific
% Imperv	percent (%)	Project-specific	Project-specific
N-imperv	--	0.011 – 0.024 presented in Table A.6 of SWMM Manual	default use 0.012 for smooth concrete, otherwise provide documentation of other surface consistent with Table A.6 of SWMM Manual
N-Perv	--	0.05 – 0.80 presented in Table A.6 of SWMM Manual	default use 0.15 for short prairie grass, otherwise provide documentation of other surface consistent with Table A.6 of SWMM Manual
Dstore-Imperv	inches	0.05 – 0.10 inches presented in Table A.5 of SWMM Manual	0.05
Dstore-Perv	inches	0.10 – 0.30 inches presented in Table A.5 of SWMM Manual	0.10
%ZeroImperv	percent (%)	0% – 100%	25%
Subarea routing	--	OUTLET IMPERVIOUS PERVIOUS	Project-specific, typically OUTLET
Percent Routed	%	0% – 100%	Project-specific, typically 100%
Infiltration	Method	HORTON GREEN_AMPT CURVE_NUMBER	GREEN_AMPT

Appendix G: Guidance for Continuous Simulation and Hydromodification Management Sizing Factors

SWMM Parameter Name	Unit	Range	Use in San Diego
Suction Head (Green-Ampt)	Inches	1.93 – 12.60 presented in Table A.2 of SWMM Manual	Hydrologic Soil Group A: 1.5 Hydrologic Soil Group B: 3.0 Hydrologic Soil Group C: 6.0 Hydrologic Soil Group D: 9.0
Conductivity (Green-Ampt)	Inches per hour	0.01 – 4.74 presented in Table A.2 of SWMM Manual by soil texture class 0.00 – ≥ 0.45 presented in Table A.3 of SWMM Manual by hydrologic soil group	Hydrologic Soil Group A: 0.3 Hydrologic Soil Group B: 0.2 Hydrologic Soil Group C: 0.1 Hydrologic Soil Group D: 0.025 Note: reduce conductivity by 25% in the post-project condition when native soils will be compacted. Conductivity may also be reduced by 25% in the pre-development condition model for redevelopment areas that are currently concrete or asphalt but must be modeled according to their underlying soil characteristics. For fill soils in post-project condition, see Section G.1.4.3.
Initial Deficit (Green-Ampt)		The difference between soil porosity and initial moisture content. Based on the values provided in Table A.2 of SWMM Manual, the range for completely dry soil would be 0.097 to 0.375	Hydrologic Soil Group A: 0.30 Hydrologic Soil Group B: 0.31 Hydrologic Soil Group C: 0.32 Hydrologic Soil Group D: 0.33 Note: in long-term continuous simulation, this value is not important as the soil will reach equilibrium after a few storm events regardless of the initial moisture content specified.
Groundwater	yes/no	yes/no	NO
LID Controls			Project Specific

Appendix G: Guidance for Continuous Simulation and Hydromodification Management Sizing Factors

SWMM Parameter Name	Unit	Range	Use in San Diego
Snow Pack Land Uses Initial Buildup Curb Length			Not applicable to hydromodification management studies

G.1.4.3 Pervious Area Rainfall Loss Parameters in Post-Project Condition (HSPF, SDHM, and SWMM)

The following guidance applies to HSPF, SDHM, and SWMM. When modeling pervious areas in the post-project condition, fill soils shall be modeled as hydrologic soil group Type D soils, or the project applicant may provide an actual expected infiltration rate for the fill soil based on testing (must be approved by the City Engineer for use in the model). Where landscaped areas on fill soils will be re-tilled and/or amended in the post-project condition, the landscaped areas may be modeled as Type C soils. Areas to be re-tilled and/or amended in the post-project condition must be shown on the project plans. For undisturbed pervious areas (i.e., native soils, no fill), use the actual hydrologic soil group, the same as in the pre-development condition.

G.1.5 MODELING STRUCTURAL BMPs (PONDS AND LID FEATURES)

There are many ways to model structural BMPs. There are standard modules for several pond or LID elements included in SDHM and SWMM. Users may also set up project-specific stage-storage-discharge relationships representing structural BMPs. Regardless of the modeling method, certain characteristics of the structural BMP, including infiltration of water from the bottom of the structural BMP into native soils, porosity of bioretention soils and/or gravel sublayers, and other program-specific parameters must be consistent with those presented below, unless the preparer can provide documentation to substantiate use of other parameters, subject to local jurisdiction approval. The geometry of structural BMPs is project-specific and shall match the project plans.

G.1.5.1 Infiltration into Native Soils Below Structural BMPs

Infiltration into native soils below structural BMPs may be modeled as a constant outflow rate equal to the project site-specific design infiltration rate (Worksheet D.5-1) multiplied by the area of the infiltrating surface (and converted to cubic feet per second). This infiltration rate is not the same as an infiltration parameter used in the calculation of rainfall losses, such as the HSPF INFILT parameter or the Green-Ampt conductivity parameter in the SWMM subcatchment module. It must be site-specific and must be determined based on the methods presented in Appendix D of this manual.

Appendix G: Guidance for Continuous Simulation and Hydromodification Management Sizing Factors

For preliminary analysis when site-specific geotechnical investigation has not been completed, project applicants proposing infiltration into native soils as part of the structural BMP design shall prepare a sensitivity analysis to determine a potential range for the structural BMP size based on a range of potential infiltration rates. As shown in Appendices C and D of this manual, many factors influence the ability to infiltrate storm water. Therefore even when soils types A and B are present, which are generally expected to infiltrate storm water, the possibility that a very low infiltration rate could be determined at design level must be considered. The range of potential infiltration rates for preliminary analysis is shown below in Table G.1-5.

Table G.1-5: Range of Potential Infiltration Rates to be Studied for Sensitivity Analysis when Native Infiltration is Proposed but Site-Specific Geotechnical Investigation has not been Completed

Hydrologic Soil Group at Location of Proposed Structural BMP	Low Infiltration Rate for Preliminary Study (inches/hour)	High Infiltration Rate for Preliminary Study (inches/hour)
A	0.02	2.4
B	0.02	0.52
C	0	0.08
D	0	0.02

The infiltration rates shown above are for preliminary investigation only. Final design of a structural BMP must be based on the project site-specific design infiltration rate (Worksheet D.5-1).

G.1.5.2 Structural BMPs That Do Not Include Sub-Layers (Ponds)

To model a pond, basin, or other depressed area that does not include processing runoff through sublayers of amended soil and/or gravel, create a stage storage discharge relationship for the pond, and supply the information to the model according to the program requirements. For HSPF users, the stage-storage-discharge relationship is provided in FTABLES. SDHM users may use the TRAPEZOIDAL POND element for a trapezoidal pond or IRREGULAR POND element to request the program to create the stage-storage-discharge relationship, use the SSD TABLE element to supply a user-created stage-storage-discharge relationship, or use other available modules such as TANK or VAULT. For SWMM users, the stage-storage relationship is supplied in the storage unit module, and the stage-discharge relationship may be represented by various other modules such as the orifice, weir, or outlet modules. Stage-storage and stage-discharge curves for structural BMPs must be fully documented in the project-specific HMP report and must be consistent with the structural BMP(s) shown on project plans.

For user-created stage-discharge relationships, refer to local drainage manual criteria for equations representing hydraulic behavior of outlet structures. Users relying on the software to develop the

Appendix G: Guidance for Continuous Simulation and Hydromodification Management Sizing Factors

stage-discharge relationship may use the equations built into the program. This manual does not recommend that all program modules calculating stage-discharge relationships must be uniform because the flows to be controlled for hydromodification management are low flows, calculated differently from the single-storm event peak flows studied for flood control purposes, and hydromodification management performance standards do not represent any performance standard for flood control drainage design. Note that for design of emergency outlet structures, and any calculations related to single-storm event routing for flood control drainage design, stage-discharge calculations must be consistent with the local drainage design requirements. This may require separate calculations for stage-discharge relationship pursuant to local manuals. The HMP flow rates shall not be used for flood control calculations.

G.1.5.3 Structural BMPs That Include Sub-Layers (Bioretention and Other LID)

G.1.5.3.1 Characteristics of Engineered Soil Media

The engineered soil media used in bioretention, biofiltration with partial retention, and biofiltration structural BMPs is a sandy loam. The following parameters presented in Table G.1-6 are characteristics of a sandy loam for use in continuous simulation models.

Table G.1-6: Characteristics of Sandy Loam to Represent Engineered Soil Media in Continuous Simulation for Hydromodification Management Studies in San Diego

Soil Texture	Porosity	Field Capacity	Wilting Point	Conductivity	Suction Head
Sandy Loam	0.4	0.2	0.1	5 inches/hour	1.5 inches

- Porosity is the volume of pore space (voids) relative to the total volume of soil (as a fraction).
- Field Capacity is the volume of pore water relative to total volume after the soil has been allowed to drain fully (as a fraction). Below this level, vertical drainage of water through the soil layer does not occur.
- Wilting point is the volume of pore water relative to total volume for a well dried soil where only bound water remains (as a fraction). The moisture content of the soil cannot fall below this limit.
- Conductivity is the hydraulic conductivity for the fully saturated soil (in/hr or mm/hr).
- Suction head is the average value of soil capillary suction along the wetting front (inches or mm).

Figures G.1-3 and G.1-4, from <http://www.stevenswater.com/articles/irrigationscheduling.aspx>,

Appendix G: Guidance for Continuous Simulation and Hydromodification Management Sizing Factors

illustrate unsaturated soil and soil saturation, field capacity, and wilting point.

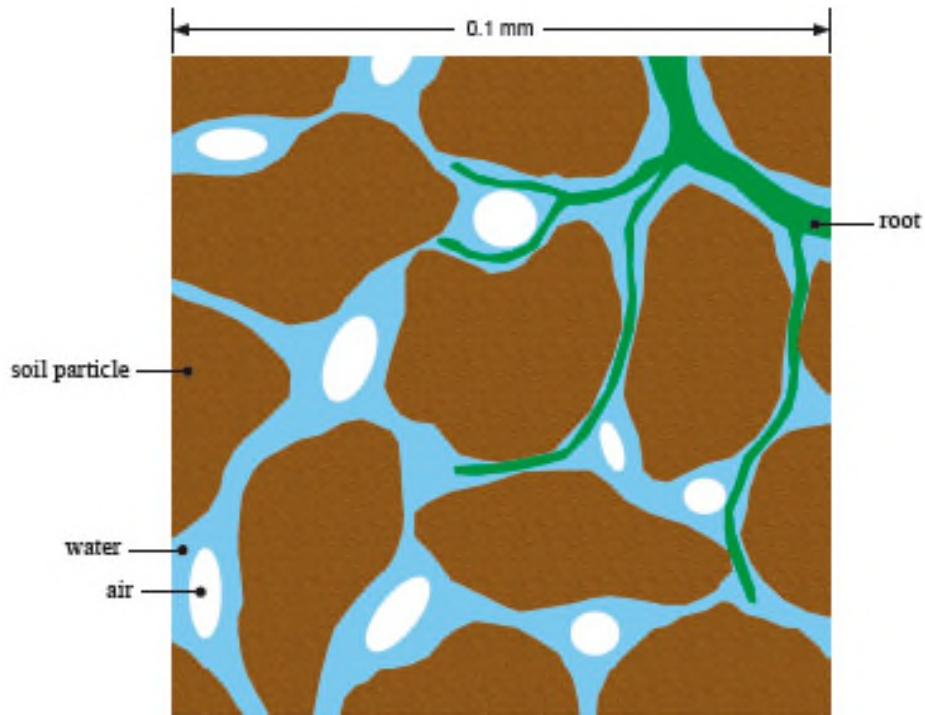

Figure G.1-3: Unsaturated Soil Composition

Unsaturated soil is composed of solid particles, organic material and pores. The pore space will contain air and water.

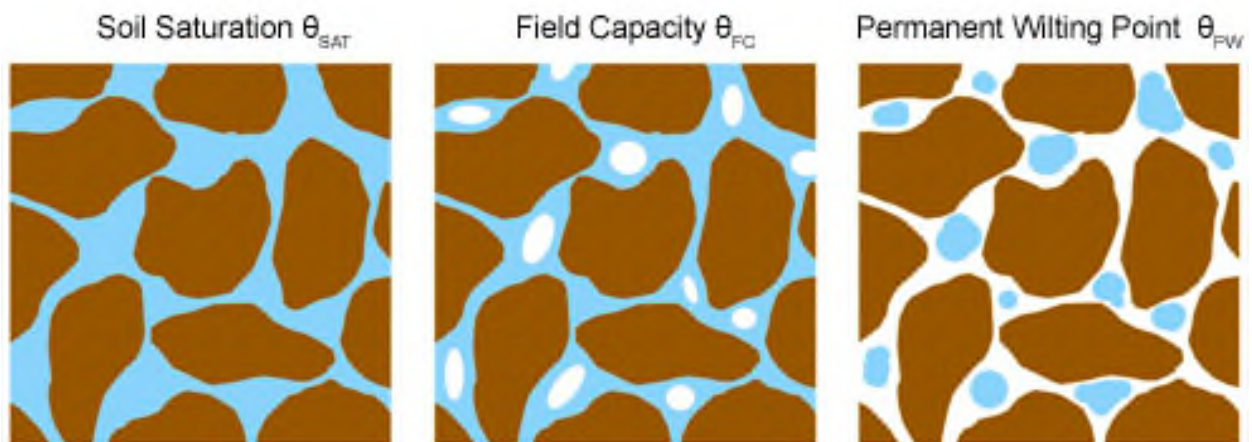

Figure G.1-4: Soil saturation, field capacity, and wilting point

Appendix G: Guidance for Continuous Simulation and Hydromodification Management Sizing Factors

G.1.5.3.2 Characteristics of Gravel

For the purpose of hydromodification management studies, it may be assumed that water moves freely through gravel, not limited by hydraulic properties of the gravel. For the purpose of calculating available volume, use porosity of 0.4, or void ratio of 0.67. Porosity is equal to void ratio divided by (1 + void ratio).

G.1.5.3.3 Additional Guidance for SDHM Users

The module titled "bioretention/rain garden element" may be used to represent bioretention or biofiltration BMPs. SDHM users using the available "bioretention/rain garden element" shall customize the soil media characteristics to use the parameters from Table G.1-6 above, and select "gravel" for gravel sublayers. All other input variables are project-specific. "Native infiltration" refers to infiltration from the bottom of the structural BMP into the native soil. This variable is project-specific, see Section G.1.5.1.

G.1.5.3.4 Additional Guidance for SWMM Users

The "bio-retention cell" LID control may be used to represent bioretention or biofiltration BMPs. Table G.1-7 provides parameters required for the standard "bio-retention cell" available in SWMM. The parameters are entered in the LID Control Editor.

Table G.1-7: Parameters for SWMM "Bio-Retention Cell" Module for Hydromodification Management Studies in San Diego

SWMM Parameter Name	Unit	Use in San Diego
<i>Surface</i>		
Berm Height also known as Storage Depth	inches	Project-specific
Vegetative Volume Fraction also known as Vegetative Cover Fraction	---	0
Surface Roughness	---	0 (this parameter is not applicable to bio-retention cell)
Surface Slope	---	0 (this parameter is not applicable to bio-retention cell)
<i>Soil</i>		
Thickness	inches	project-specific
Porosity	---	0.40
Field Capacity	---	0.2

Appendix G: Guidance for Continuous Simulation and Hydromodification Management Sizing Factors

SWMM Parameter Name	Unit	Use in San Diego
Wilting Point	---	0.1
Conductivity	Inches/hour	5
Conductivity Slope	---	5
Suction Head	inches	1.5
Storage		
Thickness also known as Height	inches	Project-specific
Void Ratio	---	0.67
Seepage Rate also known as Conductivity	Inches/hour	Conductivity from the storage layer refers to infiltration from the bottom of the structural BMP into the native soil. This variable is project-specific, see Section G.5.1. Use 0 if the bio-retention cell includes an impermeable liner
Clogging Factor	---	0
Underdrain		
Flow Coefficient Also known as Drain Coefficient	---	Project-specific
Flow Exponent Also known as Drain Exponent	---	Project-specific, typically 0.5
Offset Height Also known as Drain Offset Height	Inches	Project-specific

G.1.6 FLOW FREQUENCY AND DURATION

The continuous simulation model will generate a flow record corresponding to the frequency of the rainfall data input as its output. This flow record must then be processed to determine pre-development and post-project flow rates and durations. Compliance with hydromodification management requirements of this manual is achieved when results for flow duration meet the performance standards. The performance standard is as follows (also presented in Chapter 6 of this manual):

1. For flow rates ranging from 10 percent, 30 percent or 50 percent of the pre-development 2-year runoff event ($0.1Q_2$, $0.3Q_2$, or $0.5Q_2$) to the pre-development 10-year runoff event (Q_{10}), the post-project discharge rates and durations must not exceed the pre-development rates and

Appendix G: Guidance for Continuous Simulation and Hydromodification Management Sizing Factors

durations by more than 10 percent. The specific lower flow threshold will depend on the erosion susceptibility of the receiving stream for the project site (see Section 6.3.4).

To demonstrate that a flow control facility meets the hydromodification management performance standard, a flow duration summary must be generated and compared for pre-development and post-project conditions. The following guidelines shall be used for determining flow rates and durations.

G.1.6.1 Determining Flow Rates from Continuous Hourly Flow Output

Flow rates for hydromodification management studies in San Diego must be based on partial duration series analysis of the continuous hourly flow output. Partial duration series frequency calculations consider multiple storm events in a given year. To construct the partial duration series:

1. Parse the continuous hourly flow data into discrete runoff events. The following separation criteria may be used for separation of flow events: a new discrete event is designated when the flow falls below an artificially low flow value based on a fraction of the contributing watershed area (e.g., 0.002 to 0.005 cfs/acre) for a time period of 24 hours. Project applicants may consider other separation criteria provided the separation interval is not more than 24 hours and the criteria is clearly described in the submittal document.
2. Rank the peak flows from each discrete flow event, and compute the return interval or plotting position for each event.

Readers who are unfamiliar with how to compute the partial-duration series should consult reference books or online resources for additional information. For example, *Hydrology for Engineers*, by Linsley et al, 1982, discusses partial-duration series on pages 373-374 and computing recurrence intervals or plotting positions on page 359. *Handbook of Applied Hydrology*, by Chow, 1964, contains a detailed discussion of flow frequency analysis, including Annual Exceedance, Partial-Duration and Extreme Value series methods, in Chapter 8. The US Geological Survey (USGS) has several hydrologic study reports available online that use partial duration series statistics (see <http://water.usgs.gov/> and http://water.usgs.gov/osw/bulletin17b/AGU_Langbein_1949.pdf).

Pre-development Q_2 and Q_{10} shall be determined from the partial duration analysis for the pre-development hourly flow record. Pre-development Q_{10} is the upper threshold of flow rates to be controlled in the post-project condition. The lower flow threshold is a fraction of the pre-development Q_2 determined based on the erosion susceptibility of the receiving stream. Simply multiply the pre-development Q_2 by the appropriate fraction (e.g., $0.1Q_2$) to determine the lower flow threshold.

G.1.6.2 Determining Flow Durations from Continuous Hourly Flow Output

Flow durations must be summarized within the range of flows to control. Flow duration statistics provide a simple summary of how often a particular flow rate is exceeded. To prepare this summary:

1. Rank the entire hourly runoff time series output.

Appendix G: Guidance for Continuous Simulation and Hydromodification Management Sizing Factors

2. Extract the portion of the ranked hourly time series output from the lower flow threshold to the upper flow threshold – this is the portion of the record to be summarized.
3. Divide the applicable portion of the record into 100 equal flow bins (compute the difference between the upper flow threshold (cfs) and lower flow threshold (cfs) and divide this value by 99 to establish the flow bin size).
4. Count the number of hours of flow that fall into each flow bin.

Both pre-development and post-project flow duration summary must be based on the entire length of the flow record. Compare the post-project flow duration summary to the pre-development flow duration summary to determine if it meets performance criteria for post-project flow rates and durations (criteria presented under Section G.1.6).

G.2 Sizing Factors for Hydromodification Management BMPs

This section presents sizing factors for design of flow control structural BMPs based on the sizing factor method identified in Chapter 6.3.5.1. The sizing factors are re-printed from the "San Diego BMP Sizing Calculator Methodology," dated January 2012, prepared by Brown and Caldwell (herein "BMP Sizing Calculator Methodology"). The sizing factors are linked to the specific details and descriptions that were presented in the BMP Sizing Calculator Methodology, with limited options for modifications. The sizing factors were developed based on the 2007 MS4 Permit. Although the sizing factors were developed under the 2007 MS4 Permit, the unit runoff ratios and some sizing factors developed for flow control facility sizing may still be applied at the discretion of the City Engineer. Some of the original sizing factors developed based on the 2007 MS4 Permit and presented in the BMP Sizing Calculator Methodology are not compatible with new requirements of the 2013 MS4 Permit, and therefore are not included in this manual. The sizing factor method is intended for simple studies that do not include diversion, do not include significant offsite area draining through the project from upstream, and do not include offsite area downstream of the project area. Use of the sizing factors is limited to the specific structural BMPs described in this Appendix. Sizing factors are available for the following specific structural BMPs:

- Full infiltration condition:
 - **Infiltration:** sizing factors available for A and B soils represent a below-ground structure (dry well)
 - **Bioretention:** sizing factors available for A and B soils represent a bioretention area with engineered soil media and gravel storage layer, with no underdrain and no impermeable liner
- Partial infiltration condition:
 - **Biofiltration with partial retention:** sizing factors available for C and D soils represent a bioretention area with engineered soil media and gravel storage layer, with an underdrain, with gravel storage below the underdrain, with no impermeable liner
- No infiltration condition:
 - **Biofiltration:** sizing factors available for C and D soils represent a bioretention area with engineered soil media and gravel storage layer, with an underdrain, without gravel storage below the underdrain, with no impermeable liner
 - **Biofiltration (formerly known as "flow-through planter") with impermeable liner:** sizing factors available for C and D soils represent a biofiltration system with engineered soil media and gravel storage layer, with an underdrain, with or without

Appendix G: Guidance for Continuous Simulation and Hydromodification Management Sizing Factors

gravel storage below the underdrain, with an impermeable liner

- Other:
 - **Cistern:** sizing factors available for A, B, C, or D soils represent a vessel with a low flow orifice outlet to meet the hydromodification management performance standard.

Sizing factors were created based on three rainfall basins: Lindbergh Field, Oceanside, and Lake Wohlford.

The following information is needed to use the sizing factors:

- Determine the appropriate rainfall basin for the project site from Figure G.2-1, Rainfall Basin Map
- Hydrologic soil group at the project site (use available information pertaining to existing underlying soil type such as soil maps published by the Natural Resources Conservation Service)
- Pre-development and post-project slope categories (low = 0% – 5%, moderate = 5% – 15%, steep = >15%)
- Area tributary to the structural BMP
- Area weighted runoff factor (C) for the area draining to the BMP from Table G.2-1. Note: runoff coefficients and adjustments presented in Appendices B.1 and B.2 are for pollutant control only and are not applicable for hydromodification management studies
- Fraction of Q2 to control (see Chapter 6.3.4)

When using the sizing factor method, Worksheet G.2-1 may be used to present the calculations of the required minimum areas and/or volumes of BMPs as applicable.

Appendix G: Guidance for Continuous Simulation and Hydromodification Management Sizing Factors

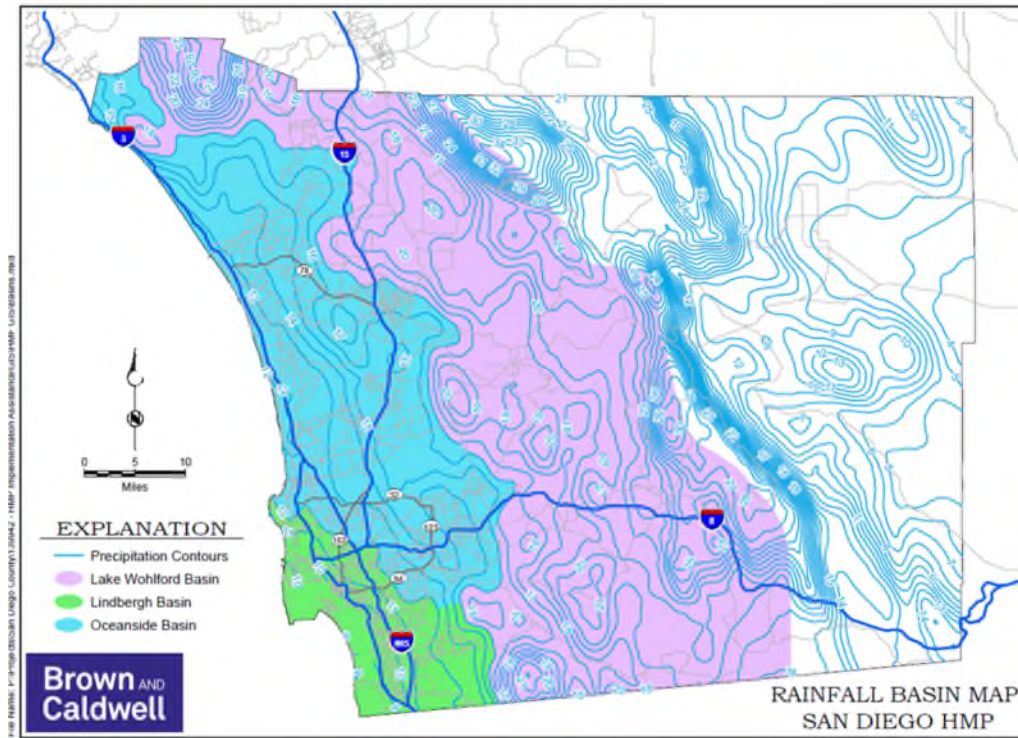

Figure G.2-1: Appropriate Rain Gauge for Project Sites

Table G.2-1: Runoff factors for surfaces draining to BMPs for Hydromodification Sizing Factor Method

Surface	Runoff Factor
Roofs	1.0
Concrete	1.0
Pervious Concrete	0.10
Porous Asphalt	0.10
Grouted Unit Pavers	1.0
Solid Unit Pavers on granular base, min. 3/16 inch joint space	0.20
Crushed Aggregate	0.10
Turf block	0.10
Amended, mulched soils	0.10
Landscape	0.10

Appendix G: Guidance for Continuous Simulation and Hydromodification Management Sizing Factors

Worksheet G.2-1: Sizing Factor Worksheet

Site Information			
Project Name:		Hydrologic Unit	
Project Applicant:		Rain: Gauge:	
Jurisdiction:		Total Project Area:	
Assessor's Parcel Number :		Low Flow Threshold:	
BMP Name:		BMP Type:	

Areas Draining to BMP						Sizing Factors			Minimum BMP Size		
DMA Name	Area (sf)	Soil Type	Pre-project Slope	Post Project Surface Type	Runoff Factor (From Table G.2-1)	Surface Area	Surface Volume	Subsurface Volume	Surface Area (sf)	Surface Volume (cf)	Subsurface Volume (cf)
Total DMA Area									Minimum BMP Size*		
									Proposed BMP Size*		

*Minimum BMP Size = Total of rows above.

*Proposed BMP Size ≥ Minimum BMP size.

G.2.1 Unit Runoff Ratios

Table G.2-2 presents unit runoff ratios for calculating pre-development Q_2 , to be used when applicable to determine the lower flow threshold for low flow orifice sizing for biofiltration with partial retention, biofiltration, biofiltration with impermeable liner, or cistern BMPs. There is no low flow orifice in the infiltration BMP or bioretention BMP. The unit runoff ratios are re-printed from the BMP Sizing Calculator methodology. Unit runoff ratios for "urban" and "impervious" cover categories were not transferred to this manual due to the requirement to control runoff to pre-development condition (see Chapter 6.3.3).

How to use the unit runoff ratios:

Obtain unit runoff ratio from Table G.2-2 based on the project's rainfall basin, hydrologic soil group, and pre-development slope (for redevelopment projects, pre-development slope may be considered if historic topographic information is available, otherwise use pre-project slope). Multiply the area tributary to the structural BMP (A, acres) by the unit runoff ratio (Q_2 , cfs/acre) to determine the pre-development Q_2 to determine the lower flow threshold, to use for low flow orifice sizing.

Table G.2-2: Unit Runoff Ratios for Sizing Factor Method

Unit Runoff Ratios for Sizing Factor Method					
Rain Gauge	Soil	Cover	Slope	Q_2 (cfs/acre)	Q_{10} (cfs/ac)
Lake Wohlford	A	Scrub	Low	0.136	0.369
Lake Wohlford	A	Scrub	Moderate	0.207	0.416
Lake Wohlford	A	Scrub	Steep	0.244	0.47
Lake Wohlford	B	Scrub	Low	0.208	0.414
Lake Wohlford	B	Scrub	Moderate	0.227	0.448
Lake Wohlford	B	Scrub	Steep	0.253	0.482
Lake Wohlford	C	Scrub	Low	0.245	0.458
Lake Wohlford	C	Scrub	Moderate	0.253	0.481
Lake Wohlford	C	Scrub	Steep	0.302	0.517
Lake Wohlford	D	Scrub	Low	0.253	0.48
Lake Wohlford	D	Scrub	Moderate	0.292	0.516
Lake Wohlford	D	Scrub	Steep	0.351	0.538

Appendix G: Guidance for Continuous Simulation and Hydromodification Management Sizing Factors

Unit Runoff Ratios for Sizing Factor Method					
Rain Gauge	Soil	Cover	Slope	Q ₂ (cfs/acre)	Q ₁₀ (cfs/ac)
Oceanside	A	Scrub	Low	0.035	0.32
Oceanside	A	Scrub	Moderate	0.093	0.367
Oceanside	A	Scrub	Steep	0.163	0.42
Oceanside	B	Scrub	Low	0.08	0.365
Oceanside	B	Scrub	Moderate	0.134	0.4
Oceanside	B	Scrub	Steep	0.181	0.433
Oceanside	C	Scrub	Low	0.146	0.411
Oceanside	C	Scrub	Moderate	0.185	0.433
Oceanside	C	Scrub	Steep	0.217	0.458
Oceanside	D	Scrub	Low	0.175	0.434
Oceanside	D	Scrub	Moderate	0.212	0.455
Oceanside	D	Scrub	Steep	0.244	0.571
Lindbergh	A	Scrub	Low	0.003	0.081
Lindbergh	A	Scrub	Moderate	0.018	0.137
Lindbergh	A	Scrub	Steep	0.061	0.211
Lindbergh	B	Scrub	Low	0.011	0.134
Lindbergh	B	Scrub	Moderate	0.033	0.174
Lindbergh	B	Scrub	Steep	0.077	0.23
Lindbergh	C	Scrub	Low	0.028	0.19
Lindbergh	C	Scrub	Moderate	0.075	0.232
Lindbergh	C	Scrub	Steep	0.108	0.274
Lindbergh	D	Scrub	Low	0.05	0.228
Lindbergh	D	Scrub	Moderate	0.104	0.266
Lindbergh	D	Scrub	Steep	0.143	0.319

G.2.2 Sizing Factors for "Infiltration" BMP

Table G.2-3 presents sizing factors for calculating the required surface area (A) and volume (V1) for an infiltration BMP. There is no underdrain and therefore no low flow orifice in the infiltration BMP. Sizing factors were developed for hydrologic soil groups A and B only. This BMP is not applicable in hydrologic soil groups C and D. The infiltration BMP is a below-ground structure (dry well) that consists of three layers:

- Ponding layer: a nominal 6-inch ponding layer should be included below the access hatch to allow for water spreading and infiltration during intense storms.
- Soil layer [topsoil layer]: 12 inches of soil should be included to remove pollutants.
- Free draining layer [storage layer]: The drywell is sized assuming a 6-foot deep free draining layer. However, designers could use shallower facility depths [provided the minimum volume and surface area are met].

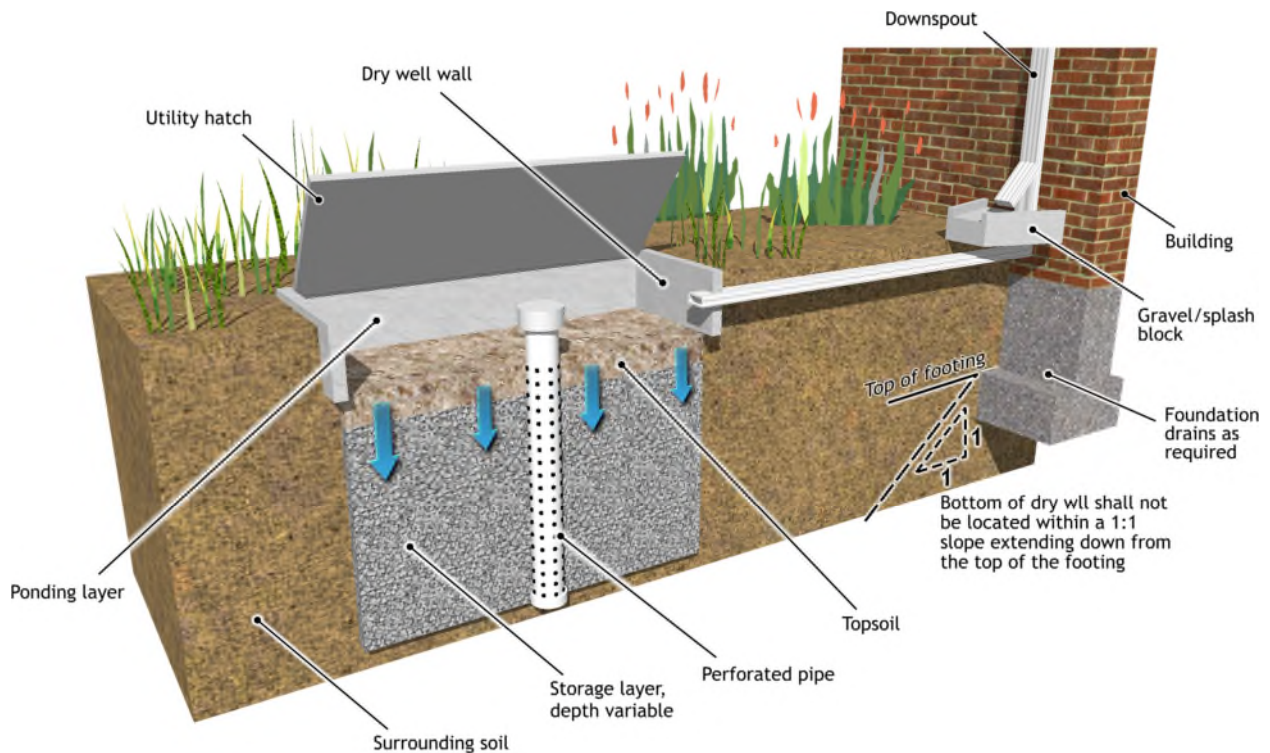

Infiltration Facility BMP Example Illustration

Reference: "San Diego BMP Sizing Calculator Methodology," prepared by Brown and Caldwell, dated January 2012

How to use the sizing factors for flow control BMP Sizing:

Obtain sizing factors from Table G.2-3 based on the project's lower flow threshold fraction of Q2, hydrologic soil group, pre-development slope, and rain gauge (rainfall basin). Multiply the area

Appendix G: Guidance for Continuous Simulation and Hydromodification Management Sizing Factors

tributary to the structural BMP (A, square feet) by the area weighted runoff factor (C, unitless) (see Table G.2-1) by the sizing factors to determine the required surface area (A, square feet) and volume (V1, cubic feet) for the infiltration BMP. The civil engineer shall provide the necessary volume and surface area of the BMP on the plans.

Additional steps to use this BMP as a combined pollutant control and flow control BMP:

To use this BMP as a combined pollutant control and flow control BMP, determine the size of the BMP using the sizing factors, then refer to Appendix B.4 to check whether the BMP meets performance standards for infiltration for pollutant control. If necessary, increase the surface area to meet the drawdown requirement for pollutant control.

Table G.2-3: Sizing Factors for Hydromodification Flow Control Infiltration BMPs Designed Using Sizing Factor Method

Sizing Factors for Hydromodification Flow Control Infiltration BMPs Designed Using Sizing Factor Method						
Lower Flow Threshold	Soil Group	Slope	Rain Gauge	A	V ₁	V ₂
0.5Q ₂	A	Flat	Lindbergh	0.040	0.1040	N/A
0.5Q ₂	A	Moderate	Lindbergh	0.040	0.1040	N/A
0.5Q ₂	A	Steep	Lindbergh	0.035	0.0910	N/A
0.5Q ₂	B	Flat	Lindbergh	0.058	0.1495	N/A
0.5Q ₂	B	Moderate	Lindbergh	0.055	0.1430	N/A
0.5Q ₂	B	Steep	Lindbergh	0.050	0.1300	N/A
0.5Q ₂	C	Flat	Lindbergh	N/A	N/A	N/A
0.5Q ₂	C	Moderate	Lindbergh	N/A	N/A	N/A
0.5Q ₂	C	Steep	Lindbergh	N/A	N/A	N/A
0.5Q ₂	D	Flat	Lindbergh	N/A	N/A	N/A
0.5Q ₂	D	Moderate	Lindbergh	N/A	N/A	N/A
0.5Q ₂	D	Steep	Lindbergh	N/A	N/A	N/A
0.5Q ₂	A	Flat	Oceanside	0.045	0.1170	N/A
0.5Q ₂	A	Moderate	Oceanside	0.045	0.1170	N/A
0.5Q ₂	A	Steep	Oceanside	0.040	0.1040	N/A
0.5Q ₂	B	Flat	Oceanside	0.065	0.1690	N/A
0.5Q ₂	B	Moderate	Oceanside	0.065	0.1690	N/A
0.5Q ₂	B	Steep	Oceanside	0.060	0.1560	N/A
0.5Q ₂	C	Flat	Oceanside	N/A	N/A	N/A
0.5Q ₂	C	Moderate	Oceanside	N/A	N/A	N/A
0.5Q ₂	C	Steep	Oceanside	N/A	N/A	N/A
0.5Q ₂	D	Flat	Oceanside	N/A	N/A	N/A

Appendix G: Guidance for Continuous Simulation and Hydromodification Management Sizing Factors

Sizing Factors for Hydromodification Flow Control Infiltration BMPs Designed Using Sizing Factor Method						
Lower Flow Threshold	Soil Group	Slope	Rain Gauge	A	V ₁	V ₂
0.5Q ₂	D	Moderate	Oceanside	N/A	N/A	N/A
0.5Q ₂	D	Steep	Oceanside	N/A	N/A	N/A
0.5Q ₂	A	Flat	L Wohlford	0.050	0.1300	N/A
0.5Q ₂	A	Moderate	L Wohlford	0.050	0.1300	N/A
0.5Q ₂	A	Steep	L Wohlford	0.040	0.1040	N/A
0.5Q ₂	B	Flat	L Wohlford	0.078	0.2015	N/A
0.5Q ₂	B	Moderate	L Wohlford	0.075	0.1950	N/A
0.5Q ₂	B	Steep	L Wohlford	0.065	0.1690	N/A
0.5Q ₂	C	Flat	L Wohlford	N/A	N/A	N/A
0.5Q ₂	C	Moderate	L Wohlford	N/A	N/A	N/A
0.5Q ₂	C	Steep	L Wohlford	N/A	N/A	N/A
0.5Q ₂	D	Flat	L Wohlford	N/A	N/A	N/A
0.5Q ₂	D	Moderate	L Wohlford	N/A	N/A	N/A
0.5Q ₂	D	Steep	L Wohlford	N/A	N/A	N/A
0.3Q ₂	A	Flat	Lindbergh	0.040	0.1040	N/A
0.3Q ₂	A	Moderate	Lindbergh	0.040	0.1040	N/A
0.3Q ₂	A	Steep	Lindbergh	0.035	0.0910	N/A
0.3Q ₂	B	Flat	Lindbergh	0.058	0.1495	N/A
0.3Q ₂	B	Moderate	Lindbergh	0.055	0.1430	N/A
0.3Q ₂	B	Steep	Lindbergh	0.050	0.1300	N/A
0.3Q ₂	C	Flat	Lindbergh	N/A	N/A	N/A
0.3Q ₂	C	Moderate	Lindbergh	N/A	N/A	N/A
0.3Q ₂	C	Steep	Lindbergh	N/A	N/A	N/A
0.3Q ₂	D	Flat	Lindbergh	N/A	N/A	N/A
0.3Q ₂	D	Moderate	Lindbergh	N/A	N/A	N/A
0.3Q ₂	D	Steep	Lindbergh	N/A	N/A	N/A
0.3Q ₂	A	Flat	Oceanside	0.045	0.1170	N/A
0.3Q ₂	A	Moderate	Oceanside	0.045	0.1170	N/A
0.3Q ₂	A	Steep	Oceanside	0.040	0.1040	N/A
0.3Q ₂	B	Flat	Oceanside	0.065	0.1690	N/A
0.3Q ₂	B	Moderate	Oceanside	0.065	0.1690	N/A
0.3Q ₂	B	Steep	Oceanside	0.060	0.1560	N/A
0.3Q ₂	C	Flat	Oceanside	N/A	N/A	N/A
0.3Q ₂	C	Moderate	Oceanside	N/A	N/A	N/A

Appendix G: Guidance for Continuous Simulation and Hydromodification Management Sizing Factors

Sizing Factors for Hydromodification Flow Control Infiltration BMPs Designed Using Sizing Factor Method						
Lower Flow Threshold	Soil Group	Slope	Rain Gauge	A	V ₁	V ₂
0.3Q ₂	C	Steep	Oceanside	N/A	N/A	N/A
0.3Q ₂	D	Flat	Oceanside	N/A	N/A	N/A
0.3Q ₂	D	Moderate	Oceanside	N/A	N/A	N/A
0.3Q ₂	D	Steep	Oceanside	N/A	N/A	N/A
0.3Q ₂	A	Flat	L Wohlford	0.050	0.1300	N/A
0.3Q ₂	A	Moderate	L Wohlford	0.050	0.1300	N/A
0.3Q ₂	A	Steep	L Wohlford	0.040	0.1040	N/A
0.3Q ₂	B	Flat	L Wohlford	0.078	0.2015	N/A
0.3Q ₂	B	Moderate	L Wohlford	0.075	0.1950	N/A
0.3Q ₂	B	Steep	L Wohlford	0.065	0.1690	N/A
0.3Q ₂	C	Flat	L Wohlford	N/A	N/A	N/A
0.3Q ₂	C	Moderate	L Wohlford	N/A	N/A	N/A
0.3Q ₂	C	Steep	L Wohlford	N/A	N/A	N/A
0.3Q ₂	D	Flat	L Wohlford	N/A	N/A	N/A
0.3Q ₂	D	Moderate	L Wohlford	N/A	N/A	N/A
0.3Q ₂	D	Steep	L Wohlford	N/A	N/A	N/A
0.1Q ₂	A	Flat	Lindbergh	0.040	0.1040	N/A
0.1Q ₂	A	Moderate	Lindbergh	0.040	0.1040	N/A
0.1Q ₂	A	Steep	Lindbergh	0.035	0.0910	N/A
0.1Q ₂	B	Flat	Lindbergh	0.058	0.1495	N/A
0.1Q ₂	B	Moderate	Lindbergh	0.055	0.1430	N/A
0.1Q ₂	B	Steep	Lindbergh	0.050	0.1300	N/A
0.1Q ₂	C	Flat	Lindbergh	N/A	N/A	N/A
0.1Q ₂	C	Moderate	Lindbergh	N/A	N/A	N/A
0.1Q ₂	C	Steep	Lindbergh	N/A	N/A	N/A
0.1Q ₂	D	Flat	Lindbergh	N/A	N/A	N/A
0.1Q ₂	D	Moderate	Lindbergh	N/A	N/A	N/A
0.1Q ₂	D	Steep	Lindbergh	N/A	N/A	N/A
0.1Q ₂	A	Flat	Oceanside	0.045	0.1170	N/A
0.1Q ₂	A	Moderate	Oceanside	0.045	0.1170	N/A
0.1Q ₂	A	Steep	Oceanside	0.040	0.1040	N/A
0.1Q ₂	B	Flat	Oceanside	0.065	0.1690	N/A
0.1Q ₂	B	Moderate	Oceanside	0.065	0.1690	N/A
0.1Q ₂	B	Steep	Oceanside	0.060	0.1560	N/A

Appendix G: Guidance for Continuous Simulation and Hydromodification Management Sizing Factors

Sizing Factors for Hydromodification Flow Control Infiltration BMPs Designed Using Sizing Factor Method						
Lower Flow Threshold	Soil Group	Slope	Rain Gauge	A	V ₁	V ₂
0.1Q ₂	C	Flat	Oceanside	N/A	N/A	N/A
0.1Q ₂	C	Moderate	Oceanside	N/A	N/A	N/A
0.1Q ₂	C	Steep	Oceanside	N/A	N/A	N/A
0.1Q ₂	D	Flat	Oceanside	N/A	N/A	N/A
0.1Q ₂	D	Moderate	Oceanside	N/A	N/A	N/A
0.1Q ₂	D	Steep	Oceanside	N/A	N/A	N/A
0.1Q ₂	A	Flat	L Wohlford	0.050	0.1300	N/A
0.1Q ₂	A	Moderate	L Wohlford	0.050	0.1300	N/A
0.1Q ₂	A	Steep	L Wohlford	0.040	0.1040	N/A
0.1Q ₂	B	Flat	L Wohlford	0.078	0.2015	N/A
0.1Q ₂	B	Moderate	L Wohlford	0.075	0.1950	N/A
0.1Q ₂	B	Steep	L Wohlford	0.065	0.1690	N/A
0.1Q ₂	C	Flat	L Wohlford	N/A	N/A	N/A
0.1Q ₂	C	Moderate	L Wohlford	N/A	N/A	N/A
0.1Q ₂	C	Steep	L Wohlford	N/A	N/A	N/A
0.1Q ₂	D	Flat	L Wohlford	N/A	N/A	N/A
0.1Q ₂	D	Moderate	L Wohlford	N/A	N/A	N/A
0.1Q ₂	D	Steep	L Wohlford	N/A	N/A	N/A

Q₂ = 2-year pre-project flow rate based upon partial duration analysis of long-term hourly rainfall records

A = Surface area sizing factor for flow control

V₁ = Infiltration volume sizing factor for flow control

Definitions for "N/A"

- Soil groups A and B: N/A in column V₂ means there is no V₂ element in this infiltration BMP for soil groups A and B
- Soil groups C and D: N/A across all elements (A, V₁, V₂) means sizing factors were not developed for an infiltration BMP for soil groups C and D

G.2.3 Sizing Factors for Bioretention

Table G.2-4 presents sizing factors for calculating the required surface area (A) and surface volume (V1) for the bioretention BMP. The bioretention BMP consists of two layers:

- Ponding layer: 10-inches active storage, [minimum] 2-inches of freeboard above overflow relief
- Growing medium: 18-inches of soil [bioretention soil media]

This BMP is applicable in soil groups A and B. This BMP does not include an underdrain or a low flow orifice. This BMP does not include an impermeable layer at the bottom of the facility to prevent infiltration into underlying soils, regardless of hydrologic soil group. If a facility is to be lined, the designer must use the sizing factors for biofiltration with impermeable layer (formerly known as "flow-through planter").

How to use the sizing factors for flow control BMP Sizing:

Obtain sizing factors from Table G.2-4 based on the project's lower flow threshold fraction of Q₂, hydrologic soil group, pre-development slope, and rain gauge (rainfall basin). Multiply the area tributary to the structural BMP (A, square feet) by the area weighted runoff factor (C, unitless) (see Table G.2-1) by the sizing factors to determine the required surface area (A, square feet) and surface volume (V₁, cubic feet). Note the surface volume is the ponding layer. The BMP must also include 18 inches of bioretention soil media which does not contribute to V₁. The civil engineer shall provide the necessary volume and surface area of the BMP on the plans.

Additional steps to use this BMP as a combined pollutant control and flow control BMP:

To use this BMP as a combined pollutant control and flow control BMP, determine the size of the BMP using the sizing factors, then refer to Appendix B.4 to check whether the BMP meets performance standards for infiltration for pollutant control. If necessary, adjust the surface area, depth of storage layer, or depth of growing medium as needed to meet pollutant control standards.

Table G.2-4: Sizing Factors for Hydromodification Flow Control Bioretention BMPs Designed Using Sizing Factor Method

Sizing Factors for Hydromodification Flow Control Bioretention BMPs Designed Using Sizing Factor Method						
Lower Flow Threshold	Soil Group	Slope	Rain Gauge	A	V ₁	V ₂
0.5Q ₂	A	Flat	Lindbergh	0.060	0.0500	N/A
0.5Q ₂	A	Moderate	Lindbergh	0.055	0.0458	N/A
0.5Q ₂	A	Steep	Lindbergh	0.045	0.0375	N/A

Appendix G: Guidance for Continuous Simulation and Hydromodification Management Sizing Factors

Sizing Factors for Hydromodification Flow Control Bioretention BMPs Designed Using Sizing Factor Method						
Lower Flow Threshold	Soil Group	Slope	Rain Gauge	A	V ₁	V ₂
0.5Q ₂	B	Flat	Lindbergh	0.093	0.0771	N/A
0.5Q ₂	B	Moderate	Lindbergh	0.085	0.0708	N/A
0.5Q ₂	B	Steep	Lindbergh	0.065	0.0542	N/A
0.5Q ₂	C	Flat	Lindbergh	N/A	N/A	N/A
0.5Q ₂	C	Moderate	Lindbergh	N/A	N/A	N/A
0.5Q ₂	C	Steep	Lindbergh	N/A	N/A	N/A
0.5Q ₂	D	Flat	Lindbergh	N/A	N/A	N/A
0.5Q ₂	D	Moderate	Lindbergh	N/A	N/A	N/A
0.5Q ₂	D	Steep	Lindbergh	N/A	N/A	N/A
0.5Q ₂	A	Flat	Oceanside	0.070	0.0583	N/A
0.5Q ₂	A	Moderate	Oceanside	0.065	0.0542	N/A
0.5Q ₂	A	Steep	Oceanside	0.060	0.0500	N/A
0.5Q ₂	B	Flat	Oceanside	0.098	0.0813	N/A
0.5Q ₂	B	Moderate	Oceanside	0.090	0.0750	N/A
0.5Q ₂	B	Steep	Oceanside	0.075	0.0625	N/A
0.5Q ₂	C	Flat	Oceanside	N/A	N/A	N/A
0.5Q ₂	C	Moderate	Oceanside	N/A	N/A	N/A
0.5Q ₂	C	Steep	Oceanside	N/A	N/A	N/A
0.5Q ₂	D	Flat	Oceanside	N/A	N/A	N/A
0.5Q ₂	D	Moderate	Oceanside	N/A	N/A	N/A
0.5Q ₂	D	Steep	Oceanside	N/A	N/A	N/A
0.5Q ₂	A	Flat	L Wohlford	0.050	0.0417	N/A
0.5Q ₂	A	Moderate	L Wohlford	0.045	0.0375	N/A
0.5Q ₂	A	Steep	L Wohlford	0.040	0.0333	N/A
0.5Q ₂	B	Flat	L Wohlford	0.048	0.0396	N/A
0.5Q ₂	B	Moderate	L Wohlford	0.045	0.0375	N/A
0.5Q ₂	B	Steep	L Wohlford	0.040	0.0333	N/A
0.5Q ₂	C	Flat	L Wohlford	N/A	N/A	N/A
0.5Q ₂	C	Moderate	L Wohlford	N/A	N/A	N/A
0.5Q ₂	C	Steep	L Wohlford	N/A	N/A	N/A
0.5Q ₂	D	Flat	L Wohlford	N/A	N/A	N/A
0.5Q ₂	D	Moderate	L Wohlford	N/A	N/A	N/A
0.5Q ₂	D	Steep	L Wohlford	N/A	N/A	N/A

Appendix G: Guidance for Continuous Simulation and Hydromodification Management Sizing Factors

Sizing Factors for Hydromodification Flow Control Bioretention BMPs Designed Using Sizing Factor Method						
Lower Flow Threshold	Soil Group	Slope	Rain Gauge	A	V ₁	V ₂
0.3Q ₂	A	Flat	Lindbergh	0.060	0.0500	N/A
0.3Q ₂	A	Moderate	Lindbergh	0.055	0.0458	N/A
0.3Q ₂	A	Steep	Lindbergh	0.045	0.0375	N/A
0.3Q ₂	B	Flat	Lindbergh	0.098	0.0813	N/A
0.3Q ₂	B	Moderate	Lindbergh	0.090	0.0750	N/A
0.3Q ₂	B	Steep	Lindbergh	0.070	0.0583	N/A
0.3Q ₂	C	Flat	Lindbergh	N/A	N/A	N/A
0.3Q ₂	C	Moderate	Lindbergh	N/A	N/A	N/A
0.3Q ₂	C	Steep	Lindbergh	N/A	N/A	N/A
0.3Q ₂	D	Flat	Lindbergh	N/A	N/A	N/A
0.3Q ₂	D	Moderate	Lindbergh	N/A	N/A	N/A
0.3Q ₂	D	Steep	Lindbergh	N/A	N/A	N/A
0.3Q ₂	A	Flat	Oceanside	0.070	0.0583	N/A
0.3Q ₂	A	Moderate	Oceanside	0.065	0.0542	N/A
0.3Q ₂	A	Steep	Oceanside	0.060	0.0500	N/A
0.3Q ₂	B	Flat	Oceanside	0.098	0.0813	N/A
0.3Q ₂	B	Moderate	Oceanside	0.090	0.0750	N/A
0.3Q ₂	B	Steep	Oceanside	0.075	0.0625	N/A
0.3Q ₂	C	Flat	Oceanside	N/A	N/A	N/A
0.3Q ₂	C	Moderate	Oceanside	N/A	N/A	N/A
0.3Q ₂	C	Steep	Oceanside	N/A	N/A	N/A
0.3Q ₂	D	Flat	Oceanside	N/A	N/A	N/A
0.3Q ₂	D	Moderate	Oceanside	N/A	N/A	N/A
0.3Q ₂	D	Steep	Oceanside	N/A	N/A	N/A
0.3Q ₂	A	Flat	L Wohlford	0.050	0.0417	N/A
0.3Q ₂	A	Moderate	L Wohlford	0.045	0.0375	N/A
0.3Q ₂	A	Steep	L Wohlford	0.040	0.0333	N/A
0.3Q ₂	B	Flat	L Wohlford	0.060	0.0500	N/A
0.3Q ₂	B	Moderate	L Wohlford	0.055	0.0458	N/A
0.3Q ₂	B	Steep	L Wohlford	0.045	0.0375	N/A
0.3Q ₂	C	Flat	L Wohlford	N/A	N/A	N/A
0.3Q ₂	C	Moderate	L Wohlford	N/A	N/A	N/A
0.3Q ₂	C	Steep	L Wohlford	N/A	N/A	N/A

Appendix G: Guidance for Continuous Simulation and Hydromodification Management Sizing Factors

Sizing Factors for Hydromodification Flow Control Bioretention BMPs Designed Using Sizing Factor Method						
Lower Flow Threshold	Soil Group	Slope	Rain Gauge	A	V ₁	V ₂
0.3Q ₂	D	Flat	L Wohlford	N/A	N/A	N/A
0.3Q ₂	D	Moderate	L Wohlford	N/A	N/A	N/A
0.3Q ₂	D	Steep	L Wohlford	N/A	N/A	N/A
0.1Q ₂	A	Flat	Lindbergh	0.060	0.0500	N/A
0.1Q ₂	A	Moderate	Lindbergh	0.055	0.0458	N/A
0.1Q ₂	A	Steep	Lindbergh	0.045	0.0375	N/A
0.1Q ₂	B	Flat	Lindbergh	0.100	0.0833	N/A
0.1Q ₂	B	Moderate	Lindbergh	0.095	0.0792	N/A
0.1Q ₂	B	Steep	Lindbergh	0.080	0.0667	N/A
0.1Q ₂	C	Flat	Lindbergh	N/A	N/A	N/A
0.1Q ₂	C	Moderate	Lindbergh	N/A	N/A	N/A
0.1Q ₂	C	Steep	Lindbergh	N/A	N/A	N/A
0.1Q ₂	D	Flat	Lindbergh	N/A	N/A	N/A
0.1Q ₂	D	Moderate	Lindbergh	N/A	N/A	N/A
0.1Q ₂	D	Steep	Lindbergh	N/A	N/A	N/A
0.1Q ₂	A	Flat	Oceanside	0.070	0.0583	N/A
0.1Q ₂	A	Moderate	Oceanside	0.065	0.0542	N/A
0.1Q ₂	A	Steep	Oceanside	0.060	0.0500	N/A
0.1Q ₂	B	Flat	Oceanside	0.103	0.0854	N/A
0.1Q ₂	B	Moderate	Oceanside	0.090	0.0750	N/A
0.1Q ₂	B	Steep	Oceanside	0.075	0.0625	N/A
0.1Q ₂	C	Flat	Oceanside	N/A	N/A	N/A
0.1Q ₂	C	Moderate	Oceanside	N/A	N/A	N/A
0.1Q ₂	C	Steep	Oceanside	N/A	N/A	N/A
0.1Q ₂	D	Flat	Oceanside	N/A	N/A	N/A
0.1Q ₂	D	Moderate	Oceanside	N/A	N/A	N/A
0.1Q ₂	D	Steep	Oceanside	N/A	N/A	N/A
0.1Q ₂	A	Flat	L Wohlford	0.050	0.0417	N/A
0.1Q ₂	A	Moderate	L Wohlford	0.045	0.0375	N/A
0.1Q ₂	A	Steep	L Wohlford	0.040	0.0333	N/A
0.1Q ₂	B	Flat	L Wohlford	0.090	0.0750	N/A
0.1Q ₂	B	Moderate	L Wohlford	0.085	0.0708	N/A
0.1Q ₂	B	Steep	L Wohlford	0.065	0.0542	N/A

Appendix G: Guidance for Continuous Simulation and Hydromodification Management Sizing Factors

Sizing Factors for Hydromodification Flow Control Bioretention BMPs Designed Using Sizing Factor Method						
Lower Flow Threshold	Soil Group	Slope	Rain Gauge	A	V ₁	V ₂
0.1Q ₂	C	Flat	L Wohlford	N/A	N/A	N/A
0.1Q ₂	C	Moderate	L Wohlford	N/A	N/A	N/A
0.1Q ₂	C	Steep	L Wohlford	N/A	N/A	N/A
0.1Q ₂	D	Flat	L Wohlford	N/A	N/A	N/A
0.1Q ₂	D	Moderate	L Wohlford	N/A	N/A	N/A
0.1Q ₂	D	Steep	L Wohlford	N/A	N/A	N/A

Q₂ = 2-year pre-project flow rate based upon partial duration analysis of long-term hourly rainfall records

A = Surface area sizing factor for flow control

V₁ = Surface volume sizing factor for flow control

Definitions for "N/A"

- Soil groups A and B: N/A in column V2 means there is no V2 element in this bioretention BMP for soil groups A and B
- Soil groups C and D: N/A in all elements (A, V1, V2) for soil groups C and D means sizing factors developed for "bioretention" in soil groups C and D under the 2007 MS4 Permit are not applicable in the "bioretention" category under the 2013 MS4 Permit because they were developed with the assumption that an underdrain is operating. Refer to Appendix G.2.4, Sizing Factors for Biofiltration with Partial Retention and Biofiltration

G.2.4 Sizing Factors for Biofiltration with Partial Retention and Biofiltration

Table G.2-5 presents sizing factors for calculating the required surface area (A), surface volume (V1), and sub-surface volume (V2) for a biofiltration with partial retention and biofiltration BMP. The BMPs consist of three layers:

- Ponding layer: 10-inches active storage, [minimum] 2-inches of freeboard above overflow relief
- Growing medium: 18-inches of soil [bioretention soil media]
- Storage layer: 30-inches of gravel at 40 percent porosity [18 inches active storage above underdrain is required, additional dead storage depth below underdrain is optional and can vary]

This BMP is applicable in soil groups C and D. This BMP includes an underdrain with a low flow orifice 18 inches (1.5 feet) below the bottom of the growing medium. This BMP can include additional dead storage below the underdrain. This BMP does not include an impermeable layer at the bottom of the facility to prevent infiltration into underlying soils, regardless of hydrologic soil group. If a facility is to be lined, the designer must use the sizing factors for biofiltration with impermeable liner (formerly known as "flow-through planter").

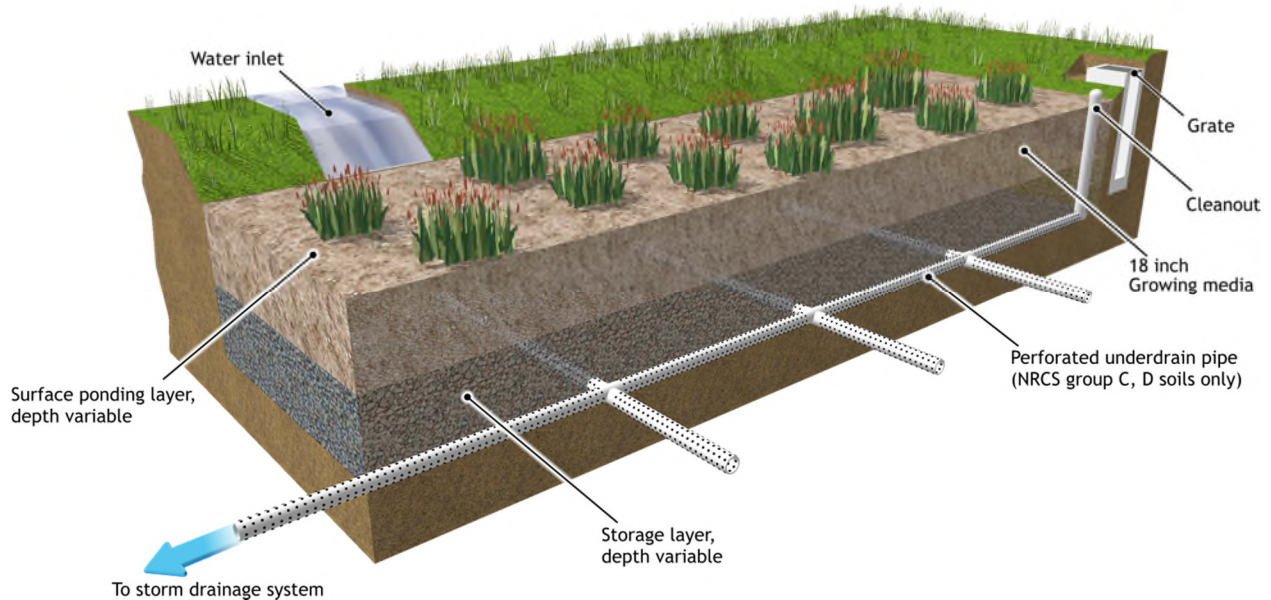

Biofiltration BMP Example Illustration

Reference: "San Diego BMP Sizing Calculator Methodology," prepared by Brown and Caldwell, dated January 2012

Appendix G: Guidance for Continuous Simulation and Hydromodification Management Sizing Factors

How to use the sizing factors for flow control BMP Sizing:

Obtain sizing factors from Table G.2-5 based on the project's lower flow threshold fraction of Q₂, hydrologic soil group, pre-development slope, and rain gauge (rainfall basin). Multiply the area tributary to the structural BMP (A, square feet) by the area weighted runoff factor (C, unitless) (see Table G.2-1) by the sizing factors to determine the required surface area (A, square feet), surface volume (V₁, cubic feet), and sub-surface volume (V₂, cubic feet). Select a low flow orifice for the underdrain that will discharge the lower flow threshold flow when there is 1.5 feet of head over the underdrain orifice. The civil engineer shall provide the necessary volume and surface area of the BMP and the underdrain and orifice detail on the plans.

Additional steps to use this BMP as a combined pollutant control and flow control BMP:

To use this BMP as a combined pollutant control and flow control BMP, determine the size of the BMP using the sizing factors. For BMPs without dead storage below the underdrain, then refer to Appendix B.5 and Appendix F to check whether the BMP meets performance standards for biofiltration for pollutant control. If necessary, adjust the surface area, depth of storage layer, or depth of growing medium as needed to meet pollutant control standards. For BMPs with dead storage below the underdrain, refer to Appendix B.4 to determine the portion of the DCV to be infiltrated for pollutant control, then Appendix B.5 and Appendix F to check whether the BMP meets performance standards for biofiltration for pollutant control for the balance of the DCV. If necessary, adjust the surface area, depth of storage layer, or depth of growing medium as needed to meet pollutant control standards.

Table G.2-5: Sizing Factors for Hydromodification Flow Control Biofiltration with Partial Retention and Biofiltration BMPs Designed Using Sizing Factor Method

Sizing Factors for Hydromodification Flow Control Biofiltration with Partial Retention and Biofiltration BMPs Designed Using Sizing Factor Method						
Lower Flow Threshold	Soil Group	Slope	Rain Gauge	A	V ₁	V ₂
0.5Q ₂	A	Flat	Lindbergh	N/A	N/A	N/A
0.5Q ₂	A	Moderate	Lindbergh	N/A	N/A	N/A
0.5Q ₂	A	Steep	Lindbergh	N/A	N/A	N/A
0.5Q ₂	B	Flat	Lindbergh	N/A	N/A	N/A
0.5Q ₂	B	Moderate	Lindbergh	N/A	N/A	N/A
0.5Q ₂	B	Steep	Lindbergh	N/A	N/A	N/A
0.5Q ₂	C	Flat	Lindbergh	0.100	0.0833	0.0600
0.5Q ₂	C	Moderate	Lindbergh	0.100	0.0833	0.0600
0.5Q ₂	C	Steep	Lindbergh	0.075	0.0625	0.0450
0.5Q ₂	D	Flat	Lindbergh	0.080	0.0667	0.0480

Appendix G: Guidance for Continuous Simulation and Hydromodification Management Sizing Factors

Sizing Factors for Hydromodification Flow Control Biofiltration with Partial Retention and Biofiltration BMPs Designed Using Sizing Factor Method						
Lower Flow Threshold	Soil Group	Slope	Rain Gauge	A	V ₁	V ₂
0.5Q ₂	D	Moderate	Lindbergh	0.080	0.0667	0.0480
0.5Q ₂	D	Steep	Lindbergh	0.060	0.0500	0.0360
0.5Q ₂	A	Flat	Oceanside	N/A	N/A	N/A
0.5Q ₂	A	Moderate	Oceanside	N/A	N/A	N/A
0.5Q ₂	A	Steep	Oceanside	N/A	N/A	N/A
0.5Q ₂	B	Flat	Oceanside	N/A	N/A	N/A
0.5Q ₂	B	Moderate	Oceanside	N/A	N/A	N/A
0.5Q ₂	B	Steep	Oceanside	N/A	N/A	N/A
0.5Q ₂	C	Flat	Oceanside	0.075	0.0625	0.0450
0.5Q ₂	C	Moderate	Oceanside	0.075	0.0625	0.0450
0.5Q ₂	C	Steep	Oceanside	0.060	0.0500	0.0360
0.5Q ₂	D	Flat	Oceanside	0.065	0.0542	0.0390
0.5Q ₂	D	Moderate	Oceanside	0.065	0.0542	0.0390
0.5Q ₂	D	Steep	Oceanside	0.050	0.0417	0.0300
0.5Q ₂	A	Flat	L Wohlford	N/A	N/A	N/A
0.5Q ₂	A	Moderate	L Wohlford	N/A	N/A	N/A
0.5Q ₂	A	Steep	L Wohlford	N/A	N/A	N/A
0.5Q ₂	B	Flat	L Wohlford	N/A	N/A	N/A
0.5Q ₂	B	Moderate	L Wohlford	N/A	N/A	N/A
0.5Q ₂	B	Steep	L Wohlford	N/A	N/A	N/A
0.5Q ₂	C	Flat	L Wohlford	0.065	0.0542	0.0390
0.5Q ₂	C	Moderate	L Wohlford	0.065	0.0542	0.0390
0.5Q ₂	C	Steep	L Wohlford	0.050	0.0417	0.0300
0.5Q ₂	D	Flat	L Wohlford	0.055	0.0458	0.0330
0.5Q ₂	D	Moderate	L Wohlford	0.055	0.0458	0.0330
0.5Q ₂	D	Steep	L Wohlford	0.045	0.0375	0.0270
0.3Q ₂	A	Flat	Lindbergh	N/A	N/A	N/A
0.3Q ₂	A	Moderate	Lindbergh	N/A	N/A	N/A
0.3Q ₂	A	Steep	Lindbergh	N/A	N/A	N/A
0.3Q ₂	B	Flat	Lindbergh	N/A	N/A	N/A
0.3Q ₂	B	Moderate	Lindbergh	N/A	N/A	N/A
0.3Q ₂	B	Steep	Lindbergh	N/A	N/A	N/A
0.3Q ₂	C	Flat	Lindbergh	0.110	0.0917	0.0660

Appendix G: Guidance for Continuous Simulation and Hydromodification Management Sizing Factors

Sizing Factors for Hydromodification Flow Control Biofiltration with Partial Retention and Biofiltration BMPs Designed Using Sizing Factor Method						
Lower Flow Threshold	Soil Group	Slope	Rain Gauge	A	V ₁	V ₂
0.3Q ₂	C	Moderate	Lindbergh	0.110	0.0917	0.0660
0.3Q ₂	C	Steep	Lindbergh	0.085	0.0708	0.0510
0.3Q ₂	D	Flat	Lindbergh	0.100	0.0833	0.0600
0.3Q ₂	D	Moderate	Lindbergh	0.100	0.0833	0.0600
0.3Q ₂	D	Steep	Lindbergh	0.070	0.0583	0.0420
0.3Q ₂	A	Flat	Oceanside	N/A	N/A	N/A
0.3Q ₂	A	Moderate	Oceanside	N/A	N/A	N/A
0.3Q ₂	A	Steep	Oceanside	N/A	N/A	N/A
0.3Q ₂	B	Flat	Oceanside	N/A	N/A	N/A
0.3Q ₂	B	Moderate	Oceanside	N/A	N/A	N/A
0.3Q ₂	B	Steep	Oceanside	N/A	N/A	N/A
0.3Q ₂	C	Flat	Oceanside	0.100	0.0833	0.0600
0.3Q ₂	C	Moderate	Oceanside	0.100	0.0833	0.0600
0.3Q ₂	C	Steep	Oceanside	0.080	0.0667	0.0480
0.3Q ₂	D	Flat	Oceanside	0.085	0.0708	0.0510
0.3Q ₂	D	Moderate	Oceanside	0.085	0.0708	0.0510
0.3Q ₂	D	Steep	Oceanside	0.065	0.0542	0.0390
0.3Q ₂	A	Flat	L Wohlford	N/A	N/A	N/A
0.3Q ₂	A	Moderate	L Wohlford	N/A	N/A	N/A
0.3Q ₂	A	Steep	L Wohlford	N/A	N/A	N/A
0.3Q ₂	B	Flat	L Wohlford	N/A	N/A	N/A
0.3Q ₂	B	Moderate	L Wohlford	N/A	N/A	N/A
0.3Q ₂	B	Steep	L Wohlford	N/A	N/A	N/A
0.3Q ₂	C	Flat	L Wohlford	0.075	0.0625	0.0450
0.3Q ₂	C	Moderate	L Wohlford	0.075	0.0625	0.0450
0.3Q ₂	C	Steep	L Wohlford	0.060	0.0500	0.0360
0.3Q ₂	D	Flat	L Wohlford	0.065	0.0542	0.0390
0.3Q ₂	D	Moderate	L Wohlford	0.065	0.0542	0.0390
0.3Q ₂	D	Steep	L Wohlford	0.050	0.0417	0.0300
0.1Q ₂	A	Flat	Lindbergh	N/A	N/A	N/A
0.1Q ₂	A	Moderate	Lindbergh	N/A	N/A	N/A
0.1Q ₂	A	Steep	Lindbergh	N/A	N/A	N/A
0.1Q ₂	B	Flat	Lindbergh	N/A	N/A	N/A

Appendix G: Guidance for Continuous Simulation and Hydromodification Management Sizing Factors

Sizing Factors for Hydromodification Flow Control Biofiltration with Partial Retention and Biofiltration BMPs Designed Using Sizing Factor Method						
Lower Flow Threshold	Soil Group	Slope	Rain Gauge	A	V ₁	V ₂
0.1Q ₂	B	Moderate	Lindbergh	N/A	N/A	N/A
0.1Q ₂	B	Steep	Lindbergh	N/A	N/A	N/A
0.1Q ₂	C	Flat	Lindbergh	0.145	0.1208	0.0870
0.1Q ₂	C	Moderate	Lindbergh	0.145	0.1208	0.0870
0.1Q ₂	C	Steep	Lindbergh	0.120	0.1000	0.0720
0.1Q ₂	D	Flat	Lindbergh	0.160	0.1333	0.0960
0.1Q ₂	D	Moderate	Lindbergh	0.160	0.1333	0.0960
0.1Q ₂	D	Steep	Lindbergh	0.115	0.0958	0.0690
0.1Q ₂	A	Flat	Oceanside	N/A	N/A	N/A
0.1Q ₂	A	Moderate	Oceanside	N/A	N/A	N/A
0.1Q ₂	A	Steep	Oceanside	N/A	N/A	N/A
0.1Q ₂	B	Flat	Oceanside	N/A	N/A	N/A
0.1Q ₂	B	Moderate	Oceanside	N/A	N/A	N/A
0.1Q ₂	B	Steep	Oceanside	N/A	N/A	N/A
0.1Q ₂	C	Flat	Oceanside	0.130	0.1083	0.0780
0.1Q ₂	C	Moderate	Oceanside	0.130	0.1083	0.0780
0.1Q ₂	C	Steep	Oceanside	0.110	0.0917	0.0660
0.1Q ₂	D	Flat	Oceanside	0.130	0.1083	0.0780
0.1Q ₂	D	Moderate	Oceanside	0.130	0.1083	0.0780
0.1Q ₂	D	Steep	Oceanside	0.065	0.0542	0.0390
0.1Q ₂	A	Flat	L Wohlford	N/A	N/A	N/A
0.1Q ₂	A	Moderate	L Wohlford	N/A	N/A	N/A
0.1Q ₂	A	Steep	L Wohlford	N/A	N/A	N/A
0.1Q ₂	B	Flat	L Wohlford	N/A	N/A	N/A
0.1Q ₂	B	Moderate	L Wohlford	N/A	N/A	N/A
0.1Q ₂	B	Steep	L Wohlford	N/A	N/A	N/A
0.1Q ₂	C	Flat	L Wohlford	0.110	0.0917	0.0660
0.1Q ₂	C	Moderate	L Wohlford	0.110	0.0917	0.0660
0.1Q ₂	C	Steep	L Wohlford	0.090	0.0750	0.0540
0.1Q ₂	D	Flat	L Wohlford	0.100	0.0833	0.0600
0.1Q ₂	D	Moderate	L Wohlford	0.100	0.0833	0.0600
0.1Q ₂	D	Steep	L Wohlford	0.075	0.0625	0.0450

Q₂ = 2-year pre-project flow rate based upon partial duration analysis of long-term hourly rainfall records

A = Surface area sizing factor for flow control

Appendix G: Guidance for Continuous Simulation and Hydromodification Management Sizing Factors

V_1 = Surface volume sizing factor for flow control

V_2 = Subsurface volume sizing factor for flow control

Definitions for "N/A"

- Soil groups A and B: N/A in all elements (A, V_1 , V_2) for soil groups A and B means sizing factors were not developed for biofiltration (i.e., with an underdrain) for soil groups A and B. If no underdrain is proposed, refer to Appendix G.2.3, Sizing Factors for Bioretention. If an underdrain is proposed, use project-specific continuous simulation modeling.

G.2.5 Sizing Factors for Biofiltration with Impermeable Liner

Table G.2-6 presents sizing factors for calculating the required surface area (A), surface volume (V1), and sub-surface volume (V2) for a biofiltration BMP with impermeable liner (formerly known as flow-through planter). The BMP consists of three layers:

- Ponding layer: 10-inches active storage, [minimum] 2-inches of freeboard above overflow relief
- Growing medium: 18-inches of soil [bioretention soil media]
- Storage layer: 30-inches of gravel at 40 percent porosity [18 inches active storage above underdrain is required, additional dead storage depth below underdrain is optional and can vary]

This BMP includes an underdrain with a low flow orifice 18 inches (1.5 feet) below the bottom of the growing medium. This BMP includes an impermeable liner to prevent infiltration into underlying soils.

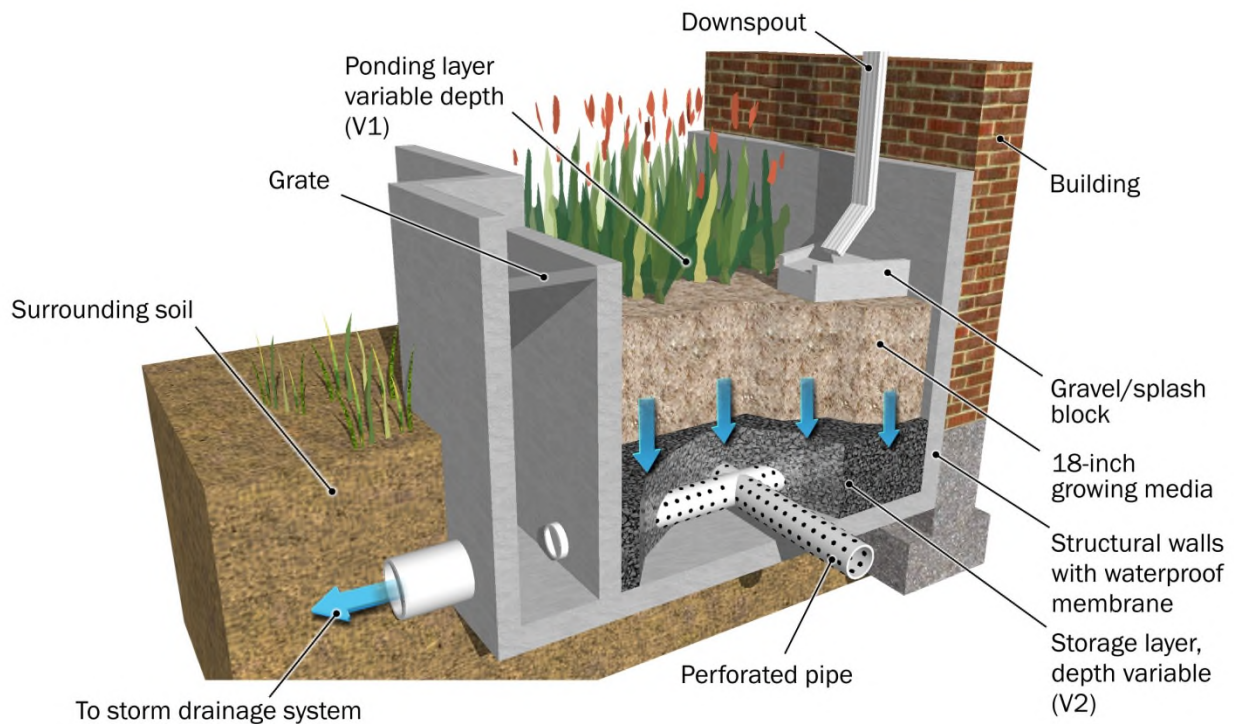

Biofiltration with impermeable liner BMP Example Illustration

Reference: "San Diego BMP Sizing Calculator Methodology," prepared by Brown and Caldwell, dated January 2012

Appendix G: Guidance for Continuous Simulation and Hydromodification Management Sizing Factors

How to use the sizing factors for flow control BMP Sizing:

Obtain sizing factors from Table G.2-6 based on the project's lower flow threshold fraction of Q₂, hydrologic soil group, pre-development slope, and rain gauge (rainfall basin). Multiply the area tributary to the structural BMP (A, square feet) by the area weighted runoff factor (C, unitless) (see Table G.2-1) by the sizing factors to determine the required surface area (A, square feet), surface volume (V₁, cubic feet), and sub-surface volume (V₂, cubic feet). Select a low flow orifice for the underdrain that will discharge the lower flow threshold flow when there is 1.5 feet of head over the underdrain orifice. The civil engineer shall provide the necessary volume and surface area of the BMP and the underdrain and orifice detail on the plans.

Additional steps to use this BMP as a combined pollutant control and flow control BMP:

To use this BMP as a combined pollutant control and flow control BMP, determine the size using the sizing factors, then refer to Appendix B.5 and Appendix F to check whether the BMP meets performance standards for biofiltration for pollutant control. If necessary, adjust the surface area, depth of growing medium, or depth of storage layer as needed to meet pollutant control standards.

Table G.2-6: Sizing Factors for Hydromodification Flow Control Biofiltration BMPs (formerly known as Flow-Through Planters) Designed Using Sizing Factor Method

Sizing Factors for Hydromodification Flow Control Biofiltration with Impermeable Liner BMPs Designed Using Sizing Factor Method						
Lower Flow Threshold	Soil Group	Slope	Rain Gauge	A	V ₁	V ₂
0.5Q ₂	A	Flat	Lindbergh	N/A	N/A	N/A
0.5Q ₂	A	Moderate	Lindbergh	N/A	N/A	N/A
0.5Q ₂	A	Steep	Lindbergh	N/A	N/A	N/A
0.5Q ₂	B	Flat	Lindbergh	N/A	N/A	N/A
0.5Q ₂	B	Moderate	Lindbergh	N/A	N/A	N/A
0.5Q ₂	B	Steep	Lindbergh	N/A	N/A	N/A
0.5Q ₂	C	Flat	Lindbergh	0.115	0.0958	0.0690
0.5Q ₂	C	Moderate	Lindbergh	0.115	0.0958	0.0690
0.5Q ₂	C	Steep	Lindbergh	0.080	0.0667	0.0480
0.5Q ₂	D	Flat	Lindbergh	0.085	0.0708	0.0510
0.5Q ₂	D	Moderate	Lindbergh	0.085	0.0708	0.0510
0.5Q ₂	D	Steep	Lindbergh	0.065	0.0542	0.0390
0.5Q ₂	A	Flat	Oceanside	N/A	N/A	N/A
0.5Q ₂	A	Moderate	Oceanside	N/A	N/A	N/A
0.5Q ₂	A	Steep	Oceanside	N/A	N/A	N/A

Appendix G: Guidance for Continuous Simulation and Hydromodification Management Sizing Factors

Sizing Factors for Hydromodification Flow Control Biofiltration with Impermeable Liner BMPs Designed Using Sizing Factor Method						
Lower Flow Threshold	Soil Group	Slope	Rain Gauge	A	V ₁	V ₂
0.5Q ₂	B	Flat	Oceanside	N/A	N/A	N/A
0.5Q ₂	B	Moderate	Oceanside	N/A	N/A	N/A
0.5Q ₂	B	Steep	Oceanside	N/A	N/A	N/A
0.5Q ₂	C	Flat	Oceanside	0.075	0.0625	0.0450
0.5Q ₂	C	Moderate	Oceanside	0.075	0.0625	0.0450
0.5Q ₂	C	Steep	Oceanside	0.065	0.0542	0.0390
0.5Q ₂	D	Flat	Oceanside	0.070	0.0583	0.0420
0.5Q ₂	D	Moderate	Oceanside	0.070	0.0583	0.0420
0.5Q ₂	D	Steep	Oceanside	0.050	0.0417	0.0300
0.5Q ₂	A	Flat	L Wohlford	N/A	N/A	N/A
0.5Q ₂	A	Moderate	L Wohlford	N/A	N/A	N/A
0.5Q ₂	A	Steep	L Wohlford	N/A	N/A	N/A
0.5Q ₂	B	Flat	L Wohlford	N/A	N/A	N/A
0.5Q ₂	B	Moderate	L Wohlford	N/A	N/A	N/A
0.5Q ₂	B	Steep	L Wohlford	N/A	N/A	N/A
0.5Q ₂	C	Flat	L Wohlford	0.070	0.0583	0.0420
0.5Q ₂	C	Moderate	L Wohlford	0.070	0.0583	0.0420
0.5Q ₂	C	Steep	L Wohlford	0.050	0.0417	0.0300
0.5Q ₂	D	Flat	L Wohlford	0.055	0.0458	0.0330
0.5Q ₂	D	Moderate	L Wohlford	0.055	0.0458	0.0330
0.5Q ₂	D	Steep	L Wohlford	0.045	0.0375	0.0270
0.3Q ₂	A	Flat	Lindbergh	N/A	N/A	N/A
0.3Q ₂	A	Moderate	Lindbergh	N/A	N/A	N/A
0.3Q ₂	A	Steep	Lindbergh	N/A	N/A	N/A
0.3Q ₂	B	Flat	Lindbergh	N/A	N/A	N/A
0.3Q ₂	B	Moderate	Lindbergh	N/A	N/A	N/A
0.3Q ₂	B	Steep	Lindbergh	N/A	N/A	N/A
0.3Q ₂	C	Flat	Lindbergh	0.130	0.1083	0.0780
0.3Q ₂	C	Moderate	Lindbergh	0.130	0.1083	0.0780
0.3Q ₂	C	Steep	Lindbergh	0.100	0.0833	0.0600
0.3Q ₂	D	Flat	Lindbergh	0.105	0.0875	0.0630
0.3Q ₂	D	Moderate	Lindbergh	0.105	0.0875	0.0630
0.3Q ₂	D	Steep	Lindbergh	0.075	0.0625	0.0450

Appendix G: Guidance for Continuous Simulation and Hydromodification Management Sizing Factors

Sizing Factors for Hydromodification Flow Control Biofiltration with Impermeable Liner BMPs Designed Using Sizing Factor Method						
Lower Flow Threshold	Soil Group	Slope	Rain Gauge	A	V ₁	V ₂
0.3Q ₂	A	Flat	Oceanside	N/A	N/A	N/A
0.3Q ₂	A	Moderate	Oceanside	N/A	N/A	N/A
0.3Q ₂	A	Steep	Oceanside	N/A	N/A	N/A
0.3Q ₂	B	Flat	Oceanside	N/A	N/A	N/A
0.3Q ₂	B	Moderate	Oceanside	N/A	N/A	N/A
0.3Q ₂	B	Steep	Oceanside	N/A	N/A	N/A
0.3Q ₂	C	Flat	Oceanside	0.105	0.0875	0.0630
0.3Q ₂	C	Moderate	Oceanside	0.105	0.0875	0.0630
0.3Q ₂	C	Steep	Oceanside	0.085	0.0708	0.0510
0.3Q ₂	D	Flat	Oceanside	0.090	0.0750	0.0540
0.3Q ₂	D	Moderate	Oceanside	0.090	0.0750	0.0540
0.3Q ₂	D	Steep	Oceanside	0.070	0.0583	0.0420
0.3Q ₂	A	Flat	L Wohlford	N/A	N/A	N/A
0.3Q ₂	A	Moderate	L Wohlford	N/A	N/A	N/A
0.3Q ₂	A	Steep	L Wohlford	N/A	N/A	N/A
0.3Q ₂	B	Flat	L Wohlford	N/A	N/A	N/A
0.3Q ₂	B	Moderate	L Wohlford	N/A	N/A	N/A
0.3Q ₂	B	Steep	L Wohlford	N/A	N/A	N/A
0.3Q ₂	C	Flat	L Wohlford	0.085	0.0708	0.0510
0.3Q ₂	C	Moderate	L Wohlford	0.085	0.0708	0.0510
0.3Q ₂	C	Steep	L Wohlford	0.060	0.0500	0.0360
0.3Q ₂	D	Flat	L Wohlford	0.065	0.0542	0.0390
0.3Q ₂	D	Moderate	L Wohlford	0.065	0.0542	0.0390
0.3Q ₂	D	Steep	L Wohlford	0.050	0.0417	0.0300
0.1Q ₂	A	Flat	Lindbergh	N/A	N/A	N/A
0.1Q ₂	A	Moderate	Lindbergh	N/A	N/A	N/A
0.1Q ₂	A	Steep	Lindbergh	N/A	N/A	N/A
0.1Q ₂	B	Flat	Lindbergh	N/A	N/A	N/A
0.1Q ₂	B	Moderate	Lindbergh	N/A	N/A	N/A
0.1Q ₂	B	Steep	Lindbergh	N/A	N/A	N/A
0.1Q ₂	C	Flat	Lindbergh	0.250	0.2083	0.1500
0.1Q ₂	C	Moderate	Lindbergh	0.250	0.2083	0.1500
0.1Q ₂	C	Steep	Lindbergh	0.185	0.1542	0.1110

Appendix G: Guidance for Continuous Simulation and Hydromodification Management Sizing Factors

Sizing Factors for Hydromodification Flow Control Biofiltration with Impermeable Liner BMPs Designed Using Sizing Factor Method						
Lower Flow Threshold	Soil Group	Slope	Rain Gauge	A	V ₁	V ₂
0.1Q ₂	D	Flat	Lindbergh	0.200	0.1667	0.1200
0.1Q ₂	D	Moderate	Lindbergh	0.200	0.1667	0.1200
0.1Q ₂	D	Steep	Lindbergh	0.130	0.1083	0.0780
0.1Q ₂	A	Flat	Oceanside	N/A	N/A	N/A
0.1Q ₂	A	Moderate	Oceanside	N/A	N/A	N/A
0.1Q ₂	A	Steep	Oceanside	N/A	N/A	N/A
0.1Q ₂	B	Flat	Oceanside	N/A	N/A	N/A
0.1Q ₂	B	Moderate	Oceanside	N/A	N/A	N/A
0.1Q ₂	B	Steep	Oceanside	N/A	N/A	N/A
0.1Q ₂	C	Flat	Oceanside	0.190	0.1583	0.1140
0.1Q ₂	C	Moderate	Oceanside	0.190	0.1583	0.1140
0.1Q ₂	C	Steep	Oceanside	0.140	0.1167	0.0840
0.1Q ₂	D	Flat	Oceanside	0.160	0.1333	0.0960
0.1Q ₂	D	Moderate	Oceanside	0.160	0.1333	0.0960
0.1Q ₂	D	Steep	Oceanside	0.105	0.0875	0.0630
0.1Q ₂	A	Flat	L Wohlford	N/A	N/A	N/A
0.1Q ₂	A	Moderate	L Wohlford	N/A	N/A	N/A
0.1Q ₂	A	Steep	L Wohlford	N/A	N/A	N/A
0.1Q ₂	B	Flat	L Wohlford	N/A	N/A	N/A
0.1Q ₂	B	Moderate	L Wohlford	N/A	N/A	N/A
0.1Q ₂	B	Steep	L Wohlford	N/A	N/A	N/A
0.1Q ₂	C	Flat	L Wohlford	0.135	0.1125	0.0810
0.1Q ₂	C	Moderate	L Wohlford	0.135	0.1125	0.0810
0.1Q ₂	C	Steep	L Wohlford	0.105	0.0875	0.0630
0.1Q ₂	D	Flat	L Wohlford	0.110	0.0917	0.0660
0.1Q ₂	D	Moderate	L Wohlford	0.110	0.0917	0.0660
0.1Q ₂	D	Steep	L Wohlford	0.080	0.0667	0.0480

Q₂ = 2-year pre-project flow rate based upon partial duration analysis of long-term hourly rainfall records

A = Surface area sizing factor for flow control

V₁ = Surface volume sizing factor for flow control

V₂ = Subsurface volume sizing factor for flow control

Appendix G: Guidance for Continuous Simulation and Hydromodification Management Sizing Factors

Definitions for "N/A"

- Soil groups A and B: N/A in all elements (A, V1, V2) for soil groups A and B means sizing factors were not developed for biofiltration (i.e., with an underdrain) for soil groups A and B. If no underdrain is proposed, refer to Appendix G.2.3, Sizing Factors for Bioretention. If an underdrain is proposed, use project-specific continuous simulation modeling.

G.2.6 Sizing Factors for "Cistern" BMP

Table G.2-7 presents sizing factors for calculating the required volume (V_1) for a cistern BMP. In this context, a "cistern" is a detention facility that stores runoff and releases it at a controlled rate. A cistern can be a component of a harvest and use system, however the sizing factor method will not account for any retention occurring in the system. The sizing factors were developed assuming runoff is released from the cistern. The sizing factors presented in this section are to meet the hydromodification management performance standard only. The cistern BMP is based on the following assumptions:

- Cistern configuration: The cistern is modeled as a 4-foot tall vessel. However, designers could use other configurations (different cistern heights), as long as the lower outlet orifice is sized to properly restrict outflows and the minimum required volume is provided.
- Cistern upper outlet: The upper outlet from the cistern would consist of a weir or other flow control structure with the overflow invert set at an elevation of $7/8$ of the water height associated with the required volume of the cistern – V_1 . For the assumed 4-foot water depth in the cistern associated with the sizing factor analysis, the overflow invert is assumed to be located at an elevation of 3.5 feet above the bottom of the cistern. The overflow weir would be sized to pass the peak design flow based on the tributary drainage area.

How to use the sizing factors:

Obtain sizing factors from Table G.2-7 based on the project's lower flow threshold fraction of Q_2 , hydrologic soil group, pre-development slope, and rain gauge (rainfall basin). Multiply the area tributary to the structural BMP (A , square feet) by the area weighted runoff factor (C , unitless) (see Table G.2-1) by the sizing factors to determine the required volume (V_1 , cubic feet). Select a low flow orifice that will discharge the lower flow threshold flow when there is 4 feet of head over the lower outlet orifice (or adjusted head as appropriate if the cistern configuration is not 4 feet tall). The civil engineer shall provide the necessary volume of the BMP and the lower outlet orifice detail on the plans.

Additional steps to use this BMP as a combined pollutant control and flow control BMP:

A cistern could be a component of a full retention, partial retention, or no retention BMP depending on how the outflow is disposed. However use of the sizing factor method for design of the cistern in a combined pollutant control and flow control system is not recommended. The sizing factor method for designing a cistern does not account for any retention or storage occurring in BMPs combined with the cistern (i.e., cistern sized using sizing factors may be larger than necessary because sizing factor method does not recognize volume losses occurring in other elements of a combined system). Furthermore when the cistern is designed using the sizing factor method, the cistern outflow must be set to the low flow threshold flow for the drainage area, which may be inconsistent with requirements for other elements of a combined system. To optimize a system in which a cistern provides temporary

Appendix G: Guidance for Continuous Simulation and Hydromodification Management Sizing Factors

storage for runoff to be either used onsite (harvest and use), infiltrated, or biofiltered, project-specific continuous simulation modeling is recommended. Refer to Sections 5.6 and 6.3.6.

Table G.2-7: Sizing Factors for Hydromodification Flow Control Cistern Facilities Designed Using Sizing Factor Method

Sizing Factors for Hydromodification Flow Control Cistern Facilities Designed Using Sizing Factor Method						
Lower Flow Threshold	Soil Group	Slope	Rain Gauge	A	V ₁	V ₂
0.5Q ₂	A	Flat	Lindbergh	N/A	0.1200	N/A
0.5Q ₂	A	Moderate	Lindbergh	N/A	0.1000	N/A
0.5Q ₂	A	Steep	Lindbergh	N/A	0.1000	N/A
0.5Q ₂	B	Flat	Lindbergh	N/A	0.3900	N/A
0.5Q ₂	B	Moderate	Lindbergh	N/A	0.2000	N/A
0.5Q ₂	B	Steep	Lindbergh	N/A	0.1200	N/A
0.5Q ₂	C	Flat	Lindbergh	N/A	0.1200	N/A
0.5Q ₂	C	Moderate	Lindbergh	N/A	0.1200	N/A
0.5Q ₂	C	Steep	Lindbergh	N/A	0.1000	N/A
0.5Q ₂	D	Flat	Lindbergh	N/A	0.1000	N/A
0.5Q ₂	D	Moderate	Lindbergh	N/A	0.1000	N/A
0.5Q ₂	D	Steep	Lindbergh	N/A	0.0800	N/A
0.5Q ₂	A	Flat	Oceanside	N/A	0.1600	N/A
0.5Q ₂	A	Moderate	Oceanside	N/A	0.1400	N/A
0.5Q ₂	A	Steep	Oceanside	N/A	0.1200	N/A
0.5Q ₂	B	Flat	Oceanside	N/A	0.1900	N/A
0.5Q ₂	B	Moderate	Oceanside	N/A	0.1600	N/A
0.5Q ₂	B	Steep	Oceanside	N/A	0.1400	N/A
0.5Q ₂	C	Flat	Oceanside	N/A	0.1400	N/A
0.5Q ₂	C	Moderate	Oceanside	N/A	0.1400	N/A
0.5Q ₂	C	Steep	Oceanside	N/A	0.1200	N/A
0.5Q ₂	D	Flat	Oceanside	N/A	0.1200	N/A
0.5Q ₂	D	Moderate	Oceanside	N/A	0.1200	N/A
0.5Q ₂	D	Steep	Oceanside	N/A	0.1000	N/A
0.5Q ₂	A	Flat	L Wohlford	N/A	0.1800	N/A
0.5Q ₂	A	Moderate	L Wohlford	N/A	0.1400	N/A
0.5Q ₂	A	Steep	L Wohlford	N/A	0.0800	N/A
0.5Q ₂	B	Flat	L Wohlford	N/A	0.2100	N/A
0.5Q ₂	B	Moderate	L Wohlford	N/A	0.2000	N/A

Appendix G: Guidance for Continuous Simulation and Hydromodification Management Sizing Factors

Sizing Factors for Hydromodification Flow Control Cistern Facilities Designed Using Sizing Factor Method						
Lower Flow Threshold	Soil Group	Slope	Rain Gauge	A	V ₁	V ₂
0.5Q ₂	B	Steep	L Wohlford	N/A	0.1400	N/A
0.5Q ₂	C	Flat	L Wohlford	N/A	0.1400	N/A
0.5Q ₂	C	Moderate	L Wohlford	N/A	0.1400	N/A
0.5Q ₂	C	Steep	L Wohlford	N/A	0.1000	N/A
0.5Q ₂	D	Flat	L Wohlford	N/A	0.1000	N/A
0.5Q ₂	D	Moderate	L Wohlford	N/A	0.1000	N/A
0.5Q ₂	D	Steep	L Wohlford	N/A	0.0800	N/A
0.3Q ₂	A	Flat	Lindbergh	N/A	0.1200	N/A
0.3Q ₂	A	Moderate	Lindbergh	N/A	0.1000	N/A
0.3Q ₂	A	Steep	Lindbergh	N/A	0.1000	N/A
0.3Q ₂	B	Flat	Lindbergh	N/A	0.5900	N/A
0.3Q ₂	B	Moderate	Lindbergh	N/A	0.3600	N/A
0.3Q ₂	B	Steep	Lindbergh	N/A	0.1800	N/A
0.3Q ₂	C	Flat	Lindbergh	N/A	0.1800	N/A
0.3Q ₂	C	Moderate	Lindbergh	N/A	0.1800	N/A
0.3Q ₂	C	Steep	Lindbergh	N/A	0.1400	N/A
0.3Q ₂	D	Flat	Lindbergh	N/A	0.1400	N/A
0.3Q ₂	D	Moderate	Lindbergh	N/A	0.1400	N/A
0.3Q ₂	D	Steep	Lindbergh	N/A	0.0800	N/A
0.3Q ₂	A	Flat	Oceanside	N/A	0.1600	N/A
0.3Q ₂	A	Moderate	Oceanside	N/A	0.1400	N/A
0.3Q ₂	A	Steep	Oceanside	N/A	0.1200	N/A
0.3Q ₂	B	Flat	Oceanside	N/A	0.2200	N/A
0.3Q ₂	B	Moderate	Oceanside	N/A	0.1800	N/A
0.3Q ₂	B	Steep	Oceanside	N/A	0.1600	N/A
0.3Q ₂	C	Flat	Oceanside	N/A	0.1600	N/A
0.3Q ₂	C	Moderate	Oceanside	N/A	0.1600	N/A
0.3Q ₂	C	Steep	Oceanside	N/A	0.1400	N/A
0.3Q ₂	D	Flat	Oceanside	N/A	0.1400	N/A
0.3Q ₂	D	Moderate	Oceanside	N/A	0.1400	N/A
0.3Q ₂	D	Steep	Oceanside	N/A	0.1200	N/A
0.3Q ₂	A	Flat	L Wohlford	N/A	0.1800	N/A
0.3Q ₂	A	Moderate	L Wohlford	N/A	0.1400	N/A
0.3Q ₂	A	Steep	L Wohlford	N/A	0.0800	N/A

Appendix G: Guidance for Continuous Simulation and Hydromodification Management Sizing Factors

Sizing Factors for Hydromodification Flow Control Cistern Facilities Designed Using Sizing Factor Method						
Lower Flow Threshold	Soil Group	Slope	Rain Gauge	A	V ₁	V ₂
0.3Q ₂	B	Flat	L Wohlford	N/A	0.2600	N/A
0.3Q ₂	B	Moderate	L Wohlford	N/A	0.2400	N/A
0.3Q ₂	B	Steep	L Wohlford	N/A	0.1800	N/A
0.3Q ₂	C	Flat	L Wohlford	N/A	0.1800	N/A
0.3Q ₂	C	Moderate	L Wohlford	N/A	0.1800	N/A
0.3Q ₂	C	Steep	L Wohlford	N/A	0.1400	N/A
0.3Q ₂	D	Flat	L Wohlford	N/A	0.1400	N/A
0.3Q ₂	D	Moderate	L Wohlford	N/A	0.1400	N/A
0.3Q ₂	D	Steep	L Wohlford	N/A	0.1000	N/A
0.1Q ₂	A	Flat	Lindbergh	N/A	0.1200	N/A
0.1Q ₂	A	Moderate	Lindbergh	N/A	0.1000	N/A
0.1Q ₂	A	Steep	Lindbergh	N/A	0.1000	N/A
0.1Q ₂	B	Flat	Lindbergh	N/A	0.5400	N/A
0.1Q ₂	B	Moderate	Lindbergh	N/A	0.7800	N/A
0.1Q ₂	B	Steep	Lindbergh	N/A	0.3400	N/A
0.1Q ₂	C	Flat	Lindbergh	N/A	0.3600	N/A
0.1Q ₂	C	Moderate	Lindbergh	N/A	0.3600	N/A
0.1Q ₂	C	Steep	Lindbergh	N/A	0.2400	N/A
0.1Q ₂	D	Flat	Lindbergh	N/A	0.2600	N/A
0.1Q ₂	D	Moderate	Lindbergh	N/A	0.2600	N/A
0.1Q ₂	D	Steep	Lindbergh	N/A	0.1600	N/A
0.1Q ₂	A	Flat	Oceanside	N/A	0.1600	N/A
0.1Q ₂	A	Moderate	Oceanside	N/A	0.1400	N/A
0.1Q ₂	A	Steep	Oceanside	N/A	0.1200	N/A
0.1Q ₂	B	Flat	Oceanside	N/A	0.5100	N/A
0.1Q ₂	B	Moderate	Oceanside	N/A	0.3400	N/A
0.1Q ₂	B	Steep	Oceanside	N/A	0.2400	N/A
0.1Q ₂	C	Flat	Oceanside	N/A	0.2600	N/A
0.1Q ₂	C	Moderate	Oceanside	N/A	0.2600	N/A
0.1Q ₂	C	Steep	Oceanside	N/A	0.2000	N/A
0.1Q ₂	D	Flat	Oceanside	N/A	0.2000	N/A
0.1Q ₂	D	Moderate	Oceanside	N/A	0.2000	N/A
0.1Q ₂	D	Steep	Oceanside	N/A	0.1800	N/A
0.1Q ₂	A	Flat	L Wohlford	N/A	0.1800	N/A

Appendix G: Guidance for Continuous Simulation and Hydromodification Management Sizing Factors

Sizing Factors for Hydromodification Flow Control Cistern Facilities Designed Using Sizing Factor Method						
Lower Flow Threshold	Soil Group	Slope	Rain Gauge	A	V ₁	V ₂
0.1Q ₂	A	Moderate	L Wohlford	N/A	0.1400	N/A
0.1Q ₂	A	Steep	L Wohlford	N/A	0.0800	N/A
0.1Q ₂	B	Flat	L Wohlford	N/A	0.4400	N/A
0.1Q ₂	B	Moderate	L Wohlford	N/A	0.4000	N/A
0.1Q ₂	B	Steep	L Wohlford	N/A	0.3200	N/A
0.1Q ₂	C	Flat	L Wohlford	N/A	0.3200	N/A
0.1Q ₂	C	Moderate	L Wohlford	N/A	0.3200	N/A
0.1Q ₂	C	Steep	L Wohlford	N/A	0.2200	N/A
0.1Q ₂	D	Flat	L Wohlford	N/A	0.2400	N/A
0.1Q ₂	D	Moderate	L Wohlford	N/A	0.2400	N/A
0.1Q ₂	D	Steep	L Wohlford	N/A	0.1800	N/A

Q₂ = 2-year pre-project flow rate based upon partial duration analysis of long-term hourly rainfall records

A = Bioretention surface area sizing factor (not applicable under this manual standards – use methods presented in Chapter 5 and Appendix B or Appendix F to size bioretention or biofiltration facility for pollutant control)

V₁ = Cistern volume sizing factor

Definitions for "N/A"

- Column V2: N/A in column V2 means there is no V2 element in the cistern BMP
- Column A: N/A in column A means there is no A element in the cistern BMP. Note sizing factors previously created for sizing a bioretention or biofiltration facility downstream of a cistern under the 2007 MS4 Permit are not applicable under the MS4 Permit.

Appendix

H

CITY OF VISTA BMP DESIGN MANUAL

Guidance for Investigating Potential Critical Coarse Sediment Yield Areas

February 2016

Appendix H Guidance for Investigating Potential Critical Coarse Sediment Yield Areas

Introduction

Identification of potential critical coarse sediment yield areas for San Diego County has been prepared based on GLU analysis. Criteria for the GLU analysis were developed and documented in the "San Diego County Regional WMAA" (herein "Regional WMAA"). Regional-level mapping of potential critical coarse sediment yield areas was prepared using regional data sets and included in the Regional WMAA. The original Regional WMAA document can be found on the Project Clean Water website at the following address:

http://www.projectcleanwater.org/index.php?option=com_content&view=article&id=75&Itemid=99

The regional-level mapping was distributed to WQIP preparers to incorporate into the WMAA attachment to the WQIP for all watersheds in San Diego County. The regional-level mapping is based on the following sources:

Dataset	Source	Year	Description
Elevation	USGS	2013	1/3 rd Arc Second (~10 meter cells) digital elevation model for San Diego County
Land Cover	SanGIS	2013	Ecology-Vegetation layer for San Diego County downloaded from SanGIS
Geology	Kennedy, M.P., and Tan, S.S.	2002	Geologic Map of the Oceanside 30'x60' Quadrangle, California, California Geological Survey, Regional Geologic Map No. 2, 1:100,000 scale.
	Kennedy, M.P., and Tan, S.S.	2008	Geologic Map of the San Diego 30'x60' Quadrangle, California, California Geological Survey, Regional Geologic Map No. 3, 1:100,000 scale.
	Todd, V.R.	2004	Preliminary Geologic Map of the El Cajon 30'x60' Quadrangle, Southern California, United States Geological Survey, Southern California Areal Mapping Project, Open File Report 2004-1361, 1:100,000 scale.
	Jennings et al.	2010	"Geologic Map of California," California Geological Survey, Map No. 2 – Geologic Map of California, 1:750,000 scale

Appendix H: Guidance for Investigation Potential Critical Coarse Sediment Yield Areas

The regional data set is a function of the inherent data resolution of the macro-level data sets and may not conform to all site conditions, or does not reflect changes to particular areas that have occurred since the underlying data was developed. This means slopes, geology, or land cover at the project site can be mischaracterized in the regional data set. This Appendix presents criteria for the GLU analysis, excerpted from the Regional WMAA, to be used when detailed project-level investigation of GLUs onsite is needed.

A project applicant should first check the map included in the WMAA for the watershed in which the project resides to determine if potential critical coarse sediment yield areas may exist within the project drainage boundaries (i.e., within or draining through the project). Generally, if the WMAA map does not indicate potential critical coarse sediment yield areas may exist within the project drainage boundaries, no further analysis is necessary. However, the City Engineer has the discretion to require additional project-level investigation even when the WMAA map does not indicate the presence of potential critical coarse sediment yield areas within the project site.

If the project is shown to impact potential critical coarse sediment yield areas based on the WMAA map, or if the City Engineer requires, project-level GLU analysis can be performed (see Section 6.2.1). Project-level GLU analysis will either confirm or invalidate the finding of the Regional WMAA maps. For project-level GLU analysis, the civil engineer shall determine slopes, geology, and land cover categories existing at the project site, and intersect this data to determine GLUs existing at the project site. The data provided in H.1 will assist the civil engineer to characterize the site.

When it has been determined based on the GLU analysis that potential critical coarse sediment yield areas are present within the project boundary, and it has been determined that downstream systems require protection (see Section 6.2.2), additional analysis may be performed that may refine the extents of actual critical coarse sediment yield areas to be protected onsite (see Section 6.2.3). Procedures for additional analysis are provided in H.2.

H.1 Criteria for GLU Analysis

There are four slope categories in the GLU analysis. Category numbers shown (1 to 4) were assigned for the purpose of GIS processing:

- 0% to 10% (1)
- 10% to 20% (2)
- 20% to 40% (3)
- >40% (4)

There are seven geology categories in the GLU analysis:

- Coarse bedrock (CB)
- Coarse sedimentary impermeable (CSI)
- Coarse sedimentary permeable (CSP)
- Fine bedrock (FB)
- Fine sedimentary impermeable (FSI)
- Fine sedimentary permeable (FSP)
- Other (O)

There are six land cover categories in the GLU analysis:

- Agriculture/grass
- Forest
- Developed
- Scrub/shrub
- Other
- Unknown

Project site slopes shall be classified into the categories based on project-level topography. Project site geology may be determined from geologic maps (may be the same as regional-level information) or classified in the field by a qualified geologist. Table H-1.1 provides information to classify geologic map units into each geology category. Project site land cover shall be determined from aerial photography and/or field visit. For reference, Table H-1.2 provides information to classify land cover categories from the SanGIS Ecology-Vegetation data set into land cover categories. The civil engineer shall not rely on the SanGIS Ecology-Vegetation data set to identify actual land cover at the project site (for project-level investigation land cover must be confirmed by aerial photo or field visit). Intersect the geologic categories, land cover categories, and slope categories within the project

Appendix H: Guidance for Investigation Potential Critical Coarse Sediment Yield Areas

boundary to create GLUs. The GLUs listed in Table H-1.3 (also shown in Table 6-1) are considered to be potential critical coarse sediment yield areas. Note the GLU nomenclature is presented in the following format: Geology – Land Cover – Slope Category (e.g., "CB-Agricultural/Grass-3" for a GLU consisting of coarse bedrock geology, agricultural/grass land cover, and 20% to 40% slope).

Appendix H: Guidance for Investigation Potential Critical Coarse Sediment Yield Areas

Table H.1-1: Geologic Grouping for Different Map Units

Map Unit	Map Name	Anticipated Grain size of Weathered Material	Bedrock or Sedimentary	Impermeable/ Permeable	Geology Grouping
gr-m	Jennings; CA	Coarse	Bedrock	Impermeable	CB
grMz	Jennings; CA	Coarse	Bedrock	Impermeable	CB
Jcr	El Cajon 30' x 60'	Coarse	Bedrock	Impermeable	CB
Jhc	El Cajon 30' x 60'	Coarse	Bedrock	Impermeable	CB
Jsp	El Cajon 30' x 60'	Coarse	Bedrock	Impermeable	CB
Ka	El Cajon 30' x 60'	Coarse	Bedrock	Impermeable	CB
Kbm	Oceanside 30' x 60'	Coarse	Bedrock	Impermeable	CB
Kbp	Oceanside 30' x 60'	Coarse	Bedrock	Impermeable	CB
Kcc	Oceanside 30' x 60'	Coarse	Bedrock	Impermeable	CB
Kcg	Oceanside 30' x 60'	Coarse	Bedrock	Impermeable	CB
Kcm	El Cajon 30' x 60'	Coarse	Bedrock	Impermeable	CB
Kcp	El Cajon 30' x 60'	Coarse	Bedrock	Impermeable	CB
Kd	San Diego & Oceanside 30' x 60'	Coarse	Bedrock	Impermeable	CB
Kdl	Oceanside 30' x 60'	Coarse	Bedrock	Impermeable	CB
Kg	Oceanside 30' x 60'	Coarse	Bedrock	Impermeable	CB
Kgbf	Oceanside 30' x 60'	Coarse	Bedrock	Impermeable	CB
Kgd	San Diego & Oceanside 30' x 60'	Coarse	Bedrock	Impermeable	CB
Kgdf	Oceanside 30' x 60'	Coarse	Bedrock	Impermeable	CB
Kgh	San Diego 30' x 60'	Coarse	Bedrock	Impermeable	CB
Kgm	El Cajon 30' x 60'	Coarse	Bedrock	Impermeable	CB
Kgm1	El Cajon 30' x 60'	Coarse	Bedrock	Impermeable	CB
Kgm2	El Cajon 30' x 60'	Coarse	Bedrock	Impermeable	CB
Kgm3	El Cajon 30' x 60'	Coarse	Bedrock	Impermeable	CB
Kgm4	El Cajon 30' x 60'	Coarse	Bedrock	Impermeable	CB
Kgp	Oceanside 30' x 60'	Coarse	Bedrock	Impermeable	CB
Kgr	El Cajon 30' x 60'	Coarse	Bedrock	Impermeable	CB
Kgu	San Diego 30' x 60'	Coarse	Bedrock	Impermeable	CB
Khg	Oceanside 30' x 60'	Coarse	Bedrock	Impermeable	CB
Ki	Oceanside 30' x 60'	Coarse	Bedrock	Impermeable	CB
Kis	Oceanside 30' x 60'	Coarse	Bedrock	Impermeable	CB
Kjd	Oceanside 30' x 60'	Coarse	Bedrock	Impermeable	CB
KJem	El Cajon 30' x 60'	Coarse	Bedrock	Impermeable	CB
KJld	El Cajon 30' x 60'	Coarse	Bedrock	Impermeable	CB

Appendix H: Guidance for Investigation Potential Critical Coarse Sediment Yield Areas

Map Unit	Map Name	Anticipated Grain size of Weathered Material	Bedrock or Sedimentary	Impermeable/ Permeable	Geology Grouping
Kjv	El Cajon 30' x 60'	Coarse	Bedrock	Impermeable	CB
Klb	El Cajon 30' x 60'	Coarse	Bedrock	Impermeable	CB
Klh	Oceanside 30' x 60'	Coarse	Bedrock	Impermeable	CB
Klp	El Cajon 30' x 60'	Coarse	Bedrock	Impermeable	CB
Km	Oceanside 30' x 60'	Coarse	Bedrock	Impermeable	CB
Kmg	Oceanside 30' x 60'	Coarse	Bedrock	Impermeable	CB
Kmgs	El Cajon 30' x 60'	Coarse	Bedrock	Impermeable	CB
Kmm	Oceanside 30' x 60'	Coarse	Bedrock	Impermeable	CB
Kpa	Oceanside 30' x 60'	Coarse	Bedrock	Impermeable	CB
Kpv	El Cajon 30' x 60'	Coarse	Bedrock	Impermeable	CB
Kqbd	Oceanside 30' x 60'	Coarse	Bedrock	Impermeable	CB
Kr	Oceanside 30' x 60'	Coarse	Bedrock	Impermeable	CB
Krm	Oceanside 30' x 60'	Coarse	Bedrock	Impermeable	CB
Krr	Oceanside 30' x 60'	Coarse	Bedrock	Impermeable	CB
Kt	San Diego & Oceanside 30' x 60'	Coarse	Bedrock	Impermeable	CB
Ktr	Oceanside 30' x 60'	Coarse	Bedrock	Impermeable	CB
Kvc	Oceanside 30' x 60'	Coarse	Bedrock	Impermeable	CB
Kwm	Oceanside 30' x 60'	Coarse	Bedrock	Impermeable	CB
Kwp	Oceanside 30' x 60'	Coarse	Bedrock	Impermeable	CB
Kwsr	Oceanside 30' x 60'	Coarse	Bedrock	Impermeable	CB
m	Jennings; CA	Coarse	Bedrock	Impermeable	CB
Mzd	Oceanside 30' x 60'	Coarse	Bedrock	Impermeable	CB
Mzg	Oceanside 30' x 60'	Coarse	Bedrock	Impermeable	CB
Mzq	Oceanside 30' x 60'	Coarse	Bedrock	Impermeable	CB
Mzs	Oceanside 30' x 60'	Coarse	Bedrock	Impermeable	CB
sch	Jennings; CA	Coarse	Bedrock	Impermeable	CB
Kp	San Diego & Oceanside 30' x 60'	Coarse	Bedrock	Impermeable	CB
Ql	El Cajon 30' x 60'	Coarse	Sedimentary	Impermeable	CSI
QTf	El Cajon 30' x 60'	Coarse	Sedimentary	Impermeable	CSI
Ec	Jennings; CA	Coarse	Sedimentary	Impermeable	CSI
K	Jennings; CA	Coarse	Sedimentary	Impermeable	CSI
Kccg	San Diego 30' x 60'	Coarse	Sedimentary	Impermeable	CSI
Kcs	San Diego 30' x 60'	Coarse	Sedimentary	Impermeable	CSI

Appendix H: Guidance for Investigation Potential Critical Coarse Sediment Yield Areas

Map Unit	Map Name	Anticipated Grain size of Weathered Material	Bedrock or Sedimentary	Impermeable/ Permeable	Geology Grouping
Kl	San Diego, Oceanside & El Cajon 30' x 60'	Coarse	Sedimentary	Impermeable	CSI
Ku	Jennings; CA	Coarse	Sedimentary	Impermeable	CSI
Qvof	Oceanside 30' x 60'	Coarse	Sedimentary	Impermeable	CSI
Qvop8a	San Diego 30' x 60'	Coarse	Sedimentary	Impermeable	CSI
Qvop9a	San Diego 30' x 60'	Coarse	Sedimentary	Impermeable	CSI
Tmsc	San Diego 30' x 60'	Coarse	Sedimentary	Impermeable	CSI
Tmss	San Diego 30' x 60'	Coarse	Sedimentary	Impermeable	CSI
Tp	San Diego & El Cajon 30' x 60'	Coarse	Sedimentary	Impermeable	CSI
Tpm	San Diego 30' x 60'	Coarse	Sedimentary	Impermeable	CSI
Tsc	San Diego 30' x 60'	Coarse	Sedimentary	Impermeable	CSI
Tscu	San Diego 30' x 60'	Coarse	Sedimentary	Impermeable	CSI
Tsd	San Diego & El Cajon 30' x 60'	Coarse	Sedimentary	Impermeable	CSI
Tsdcg	San Diego 30' x 60'	Coarse	Sedimentary	Impermeable	CSI
Tsdss	San Diego 30' x 60'	Coarse	Sedimentary	Impermeable	CSI
Tsm	Oceanside 30' x 60'	Coarse	Sedimentary	Impermeable	CSI
Tso	Oceanside 30' x 60'	Coarse	Sedimentary	Impermeable	CSI
Tst	San Diego, Oceanside & El Cajon 30' x 60'	Coarse	Sedimentary	Impermeable	CSI
Tt	San Diego & Oceanside 30' x 60'	Coarse	Sedimentary	Impermeable	CSI
Tta	Oceanside 30' x 60'	Coarse	Sedimentary	Impermeable	CSI
Tmv	San Diego, Oceanside & El Cajon 30' x 60'	Coarse	Sedimentary	Impermeable	CSI
Tsi	Oceanside 30' x 60'	Coarse	Sedimentary	Impermeable	CSI
Qvoa	San Diego & Oceanside 30' x 60'	Coarse	Sedimentary	Impermeable	CSI
Qvoa11	Oceanside 30' x 60'	Coarse	Sedimentary	Impermeable	CSI
Qvoa12	Oceanside 30' x 60'	Coarse	Sedimentary	Impermeable	CSI
Qvoa13	Oceanside 30' x 60'	Coarse	Sedimentary	Impermeable	CSI
Qvoc	Oceanside 30' x 60'	Coarse	Sedimentary	Impermeable	CSI
Qvop	San Diego & Oceanside 30' x 60'	Coarse	Sedimentary	Impermeable	CSI
Qvop1	San Diego & Oceanside 30' x 60'	Coarse	Sedimentary	Impermeable	CSI

Appendix H: Guidance for Investigation Potential Critical Coarse Sediment Yield Areas

Map Unit	Map Name	Anticipated Grain size of Weathered Material	Bedrock or Sedimentary	Impermeable/ Permeable	Geology Grouping
Qvop10	San Diego & Oceanside 30' x 60'	Coarse	Sedimentary	Impermeable	CSI
Qvop10a	San Diego 30' x 60'	Coarse	Sedimentary	Impermeable	CSI
Qvop11	San Diego & Oceanside 30' x 60'	Coarse	Sedimentary	Impermeable	CSI
Qvop11a	San Diego 30' x 60'	Coarse	Sedimentary	Impermeable	CSI
Qvop12	San Diego & Oceanside 30' x 60'	Coarse	Sedimentary	Impermeable	CSI
Qvop13	San Diego & Oceanside 30' x 60'	Coarse	Sedimentary	Impermeable	CSI
Qvop2	San Diego & Oceanside 30' x 60'	Coarse	Sedimentary	Impermeable	CSI
Qvop3	San Diego & Oceanside 30' x 60'	Coarse	Sedimentary	Impermeable	CSI
Qvop4	San Diego & Oceanside 30' x 60'	Coarse	Sedimentary	Impermeable	CSI
Qvop5	San Diego & Oceanside 30' x 60'	Coarse	Sedimentary	Impermeable	CSI
Qvop6	San Diego 30' x 60'	Coarse	Sedimentary	Impermeable	CSI
Qvop7	San Diego & Oceanside 30' x 60'	Coarse	Sedimentary	Impermeable	CSI
Qvop8	San Diego & Oceanside 30' x 60'	Coarse	Sedimentary	Impermeable	CSI
Qvop9	San Diego 30' x 60'	Coarse	Sedimentary	Impermeable	CSI
Tsa	Oceanside 30' x 60'	Coarse	Sedimentary	Impermeable	CSI
Qof	Oceanside 30' x 60'	Coarse	Sedimentary	Permeable	CSP
Qof1	Oceanside 30' x 60'	Coarse	Sedimentary	Permeable	CSP
Qof2	Oceanside 30' x 60'	Coarse	Sedimentary	Permeable	CSP
Q	Jennings; CA	Coarse	Sedimentary	Permeable	CSP
Qa	Oceanside 30' x 60'	Coarse	Sedimentary	Permeable	CSP
Qd	Oceanside 30' x 60'	Coarse	Sedimentary	Permeable	CSP
Qf	Oceanside 30' x 60'	Coarse	Sedimentary	Permeable	CSP
Qmb	San Diego & Oceanside 30' x 60'	Coarse	Sedimentary	Permeable	CSP
Qop	San Diego & Oceanside 30' x 60'	Coarse	Sedimentary	Permeable	CSP

Appendix H: Guidance for Investigation Potential Critical Coarse Sediment Yield Areas

Map Unit	Map Name	Anticipated Grain size of Weathered Material	Bedrock or Sedimentary	Impermeable/ Permeable	Geology Grouping
Qw	San Diego & Oceanside 30' x 60'	Coarse	Sedimentary	Permeable	CSP
Qyf	Oceanside 30' x 60'	Coarse	Sedimentary	Permeable	CSP
Qt	El Cajon 30' x 60'	Coarse	Sedimentary	Permeable	CSP
Qoa1-2	Oceanside 30' x 60'	Coarse	Sedimentary	Permeable	CSP
Qoa2-6	Oceanside 30' x 60'	Coarse	Sedimentary	Permeable	CSP
Qoa5	Oceanside 30' x 60'	Coarse	Sedimentary	Permeable	CSP
Qoa6	Oceanside 30' x 60'	Coarse	Sedimentary	Permeable	CSP
Qoa7	Oceanside 30' x 60'	Coarse	Sedimentary	Permeable	CSP
Qoc	Oceanside 30' x 60'	Coarse	Sedimentary	Permeable	CSP
Qop1	Oceanside 30' x 60'	Coarse	Sedimentary	Permeable	CSP
Qc	El Cajon 30' x 60'	Coarse	Sedimentary	Permeable	CSP
Qu	El Cajon 30' x 60'	Coarse	Sedimentary	Permeable	CSP
Qoa	San Diego, Oceanside & El Cajon 30' x 60'	Coarse	Sedimentary	Permeable	CSP
Qop2-4	San Diego 30' x 60'	Coarse	Sedimentary	Permeable	CSP
Qop3	Oceanside 30' x 60'	Coarse	Sedimentary	Permeable	CSP
Qop4	Oceanside 30' x 60'	Coarse	Sedimentary	Permeable	CSP
Qop6	San Diego & Oceanside 30' x 60'	Coarse	Sedimentary	Permeable	CSP
Qop7	San Diego & Oceanside 30' x 60'	Coarse	Sedimentary	Permeable	CSP
Qya	San Diego, Oceanside & El Cajon 30' x 60'	Coarse	Sedimentary	Permeable	CSP
Qyc	San Diego & Oceanside 30' x 60'	Coarse	Sedimentary	Permeable	CSP
Mzu	San Diego & Oceanside 30' x 60'	Fine	Bedrock	Impermeable	FB
gb	Jennings; CA	Fine	Bedrock	Impermeable	FB
JTRm	El Cajon 30' x 60'	Fine	Bedrock	Impermeable	FB
Kat	Oceanside 30' x 60'	Fine	Bedrock	Impermeable	FB
Kc	El Cajon 30' x 60'	Fine	Bedrock	Impermeable	FB
Kgb	Oceanside 30' x 60'	Fine	Bedrock	Impermeable	FB
KJvs	El Cajon 30' x 60'	Fine	Bedrock	Impermeable	FB
Kmv	El Cajon 30' x 60'	Fine	Bedrock	Impermeable	FB
Ksp	El Cajon 30' x 60'	Fine	Bedrock	Impermeable	FB

Appendix H: Guidance for Investigation Potential Critical Coarse Sediment Yield Areas

Map Unit	Map Name	Anticipated Grain size of Weathered Material	Bedrock or Sedimentary	Impermeable/ Permeable	Geology Grouping
Kvsp	Oceanside 30' x 60'	Fine	Bedrock	Impermeable	FB
Kwmt	Oceanside 30' x 60'	Fine	Bedrock	Impermeable	FB
Qv	Jennings; CA	Fine	Bedrock	Impermeable	FB
Tba	San Diego 30' x 60'	Fine	Bedrock	Impermeable	FB
Tda	Oceanside 30' x 60'	Fine	Bedrock	Impermeable	FB
Tv	Oceanside 30' x 60'	Fine	Bedrock	Impermeable	FB
Tvsr	Oceanside 30' x 60'	Fine	Bedrock	Impermeable	FB
Kgdfg	Oceanside 30' x 60'	Fine	Bedrock	Impermeable	FB
Ta	San Diego 30' x 60'	Fine	Sedimentary	Impermeable	FSI
Tcs	Oceanside 30' x 60'	Fine	Sedimentary	Impermeable	FSI
Td	San Diego & Oceanside 30' x 60'	Fine	Sedimentary	Impermeable	FSI
Td+Tf	San Diego 30' x 60'	Fine	Sedimentary	Impermeable	FSI
Qls	San Diego, Oceanside & El Cajon 30' x 60'	Fine	Sedimentary	Impermeable	FSI
Tm	Oceanside 30' x 60'	Fine	Sedimentary	Impermeable	FSI
Tf	San Diego, Oceanside & El Cajon 30' x 60'	Fine	Sedimentary	Impermeable	FSI
Tfr	El Cajon 30' x 60'	Fine	Sedimentary	Impermeable	FSI
To	San Diego & El Cajon 30' x 60'	Fine	Sedimentary	Impermeable	FSI
Qpe	San Diego & Oceanside 30' x 60'	Fine	Sedimentary	Permeable	FSP
Mexico	San Diego 30' x 60'	NA	NA	Permeable	Other
Kuo	San Diego 30' x 60'	NA (Offshore)	NA	Permeable	Other
Teo	San Diego & Oceanside 30' x 60'	NA (Offshore)	Sedimentary	Permeable	Other
Tmo	Oceanside 30' x 60'	NA (Offshore)	Sedimentary	Permeable	Other
Qmo	San Diego 30' x 60'	NA (Offshore)	Sedimentary	Permeable	Other
QTso	San Diego 30' x 60'	NA (Offshore)	Sedimentary	Permeable	Other
af	San Diego & Oceanside 30' x 60'	Variable, dependent on source material	Sedimentary		Other

Appendix H: Guidance for Investigation Potential Critical Coarse Sediment Yield Areas

Table H.1-2: Land Cover Grouping for SanGIS Ecology-Vegetation Data Set

Id	SanGIS Legend	SanGIS Grouping	Land Cover Grouping
1	42000 Valley and Foothill Grassland	Grasslands, Vernal Pools, Meadows, and Other Herb Communities	Agricultural/Grass
2	42100 Native Grassland		Agricultural/Grass
3	42110 Valley Needlegrass Grassland		Agricultural/Grass
4	42120 Valley Sacaton Grassland		Agricultural/Grass
5	42200 Non-Native Grassland	Grasslands, Vernal Pools, Meadows, and Other Herb Communities	Agriculture/Grass
6	42300 Wildflower Field		Agriculture/Grass
7	42400 Foothill/Mountain Perennial Grassland		Agriculture/Grass
8	42470 Transmontane Dropseed Grassland		Agriculture/Grass
9	45000 Meadow and Seep		Agriculture/Grass
10	45100 Montane Meadow		Agriculture/Grass
11	45110 Wet Montane Meadow		Agriculture/Grass
12	45120 Dry Montane Meadows		Agriculture/Grass
13	45300 Alkali Meadows and Seeps		Agriculture/Grass
14	45320 Alkali Seep		Agriculture/Grass
15	45400 Freshwater Seep		Agriculture/Grass
16	46000 Alkali Playa Community		Agriculture/Grass
17	46100 Badlands/Mudhill Forbs		Agriculture/Grass
18	Non-Native Grassland		Agriculture/Grass
19	18000 General Agriculture	Non-Native Vegetation, Developed Areas, or Unvegetated Habitat	Agriculture/Grass
20	18100 Orchards and Vineyards		Agriculture/Grass
21	18200 Intensive Agriculture		Agriculture/Grass
22	18200 Intensive Agriculture - Dairies, Nurseries, Chicken Ranches		Agriculture/Grass
23	18300 Extensive Agriculture - Field/Pasture, Row Crops		Agriculture/Grass
24	18310 Field/Pasture		Agriculture/Grass
25	18310 Pasture		Agriculture/Grass
26	18320 Row Crops		Agriculture/Grass
27	12000 Urban/Developed		Developed
28	12000 Urban/Developed	Developed	
29	81100 Mixed Evergreen Forest	Forest	Forest
30	81300 Oak Forest		Forest
31	81310 Coast Live Oak Forest		Forest
32	81320 Canyon Live Oak Forest		Forest
33	81340 Black Oak Forest		Forest

Appendix H: Guidance for Investigation Potential Critical Coarse Sediment Yield Areas

Id	SanGIS Legend	SanGIS Grouping	Land Cover Grouping
34	83140 Torrey Pine Forest		Forest
35	83230 Southern Interior Cypress Forest		Forest
36	84000 Lower Montane Coniferous Forest		Forest
37	84100 Coast Range, Klamath and Peninsular Coniferous Forest		Forest
38	84140 Coulter Pine Forest	Forest	Forest
39	84150 Big cone Spruce (Big cone Douglas Fir)-Canyon Oak Forest		Forest
40	84230 Sierran Mixed Coniferous Forest		Forest
41	84500 Mixed Oak/Coniferous/Big cone/Coulter		Forest
42	85100 Jeffrey Pine Forest		Forest
43	11100 Eucalyptus Woodland		Non-Native Vegetation, Developed Areas, or Unvegetated Habitat
44	60000 RIPARIAN AND BOTTOMLAND HABITAT	Riparian and Bottomland Habitat	Forest
45	61000 Riparian Forests		Forest
46	61300 Southern Riparian Forest		Forest
47	61310 Southern Coast Live Oak Riparian Forest		Forest
48	61320 Southern Arroyo Willow Riparian Forest		Forest
49	61330 Southern Cottonwood-willow Riparian Forest		Forest
50	61510 White Alder Riparian Forest		Forest
51	61810 Sonoran Cottonwood-willow Riparian Forest		Forest
52	61820 Mesquite Bosque		Forest
53	62000 Riparian Woodlands		Forest
54	62200 Desert Dry Wash Woodland		Forest
55	62300 Desert Fan Palm Oasis Woodland		Forest
56	62400 Southern Sycamore-alder Riparian Woodland		Forest
57	70000 WOODLAND	Woodland	Forest
58	71000 Cismontane Woodland		Forest

Appendix H: Guidance for Investigation Potential Critical Coarse Sediment Yield Areas

Id	SanGIS Legend	SanGIS Grouping	Land Cover Grouping
59	71100 Oak Woodland		Forest
60	71120 Black Oak Woodland		Forest
61	71160 Coast Live Oak Woodland		Forest
62	71161 Open Coast Live Oak Woodland		Forest
63	71162 Dense Coast Live Oak Woodland		Forest
64	71162 Dense Coast Love Oak Woodland		Forest
65	71180 Engelmann Oak Woodland	Woodland	Forest
66	71181 Open Engelmann Oak Woodland		Forest
67	71182 Dense Engelmann Oak Woodland		Forest
68	72300 Peninsular Pinon and Juniper Woodlands		Forest
69	72310 Peninsular Pinon Woodland		Forest
70	72320 Peninsular Juniper Woodland and Scrub		Forest
71	75100 Elephant Tree Woodland		Forest
72	77000 Mixed Oak Woodland		Forest
73	78000 Undifferentiated Open Woodland		Forest
74	79000 Undifferentiated Dense Woodland		Forest
75	Engelmann Oak Woodland	Forest	
76	52120 Southern Coastal Salt Marsh	Bog and Marsh	Other
77	52300 Alkali Marsh		Other
78	52310 Cismontane Alkali Marsh		Other
79	52400 Freshwater Marsh		Other
80	52410 Coastal and Valley Freshwater Marsh		Other
81	52420 Transmontane Freshwater Marsh		Other
82	52440 Emergent Wetland		Other
83	44000 Vernal Pool	Grasslands, Vernal Pools, Meadows, and Other Herb Communities	Other
84	44320 San Diego Mesa Vernal Pool		Other
85	44322 San Diego Mesa Claypan Vernal Pool (southern mesas)		Other
86	13100 Open Water		Other

Appendix H: Guidance for Investigation Potential Critical Coarse Sediment Yield Areas

Id	SanGIS Legend	SanGIS Grouping	Land Cover Grouping
87	13110 Marine	Non-Native Vegetation, Developed Areas, or Unvegetated Habitat	Other
88	13111 Subtidal		Other
89	13112 Intertidal		Other
90	13121 Deep Bay		Other
91	13122 Intermediate Bay		Other
92	13123 Shallow Bay		Other
93	13130 Estuarine		Other
94	13131 Subtidal		Other
95	13133 Brackish water		Other
96	13140 Freshwater		Other
97	13200 Non-Vegetated Channel, Floodway, Lakeshore Fringe	Non-Native Vegetation, Developed Areas, or Unvegetated Habitat	Other
98	13300 Saltpan/Mudflats		Other
99	13400 Beach		Other
100	21230 Southern Foredunes	Dune Community	Scrub/Shrub
101	22100 Active Desert Dunes		Scrub/Shrub
102	22300 Stabilized and Partially-Stabilized Desert Sand Field		Scrub/Shrub
103	24000 Stabilized Alkaline Dunes		Scrub/Shrub
104	29000 ACACIA SCRUB		Scrub/Shrub
105	63000 Riparian Scrubs	Riparian and Bottomland Habitat	Scrub/Shrub
106	63300 Southern Riparian Scrub		Scrub/Shrub
107	63310 Mule Fat Scrub		Scrub/Shrub
108	63310 Mulefat Scrub		Scrub/Shrub
109	63320 Southern Willow Scrub		Scrub/Shrub
110	63321 Arundo donna Dominant/Southern Willow Scrub		Scrub/Shrub
111	63330 Southern Riparian Scrub		Scrub/Shrub
112	63400 Great Valley Scrub		Scrub/Shrub
113	63410 Great Valley Willow Scrub		Scrub/Shrub
114	63800 Colorado Riparian Scrub		Scrub/Shrub
115	63810 Tamarisk Scrub		Scrub/Shrub
116	63820 Arrowweed Scrub	Scrub/Shrub	
117	31200 Southern Coastal Bluff Scrub	Scrub and Chaparral	Scrub/Shrub
118	32000 Coastal Scrub		Scrub/Shrub
119	32400 Maritime Succulent Scrub		Scrub/Shrub
120	32500 Diegan Coastal Sage Scrub		Scrub/Shrub

Appendix H: Guidance for Investigation Potential Critical Coarse Sediment Yield Areas

Id	SanGIS Legend	SanGIS Grouping	Land Cover Grouping
121	32510 Coastal form		Scrub/Shrub
122	32520 Inland form (> 1,000 ft. elevation)		Scrub/Shrub
123	32700 Riversidian Sage Scrub		Scrub/Shrub
124	32710 Riversidian Upland Sage Scrub		Scrub/Shrub
125	32720 Alluvial Fan Scrub		Scrub/Shrub
126	33000 Sonoran Desert Scrub		Scrub/Shrub
127	33100 Sonoran Creosote Bush Scrub		Scrub/Shrub
128	33200 Sonoran Desert Mixed Scrub		Scrub/Shrub
129	33210 Sonoran Mixed Woody Scrub		Scrub/Shrub
130	33220 Sonoran Mixed Woody and Succulent Scrub		Scrub and Chaparral
131	33230 Sonoran Wash Scrub	Scrub/Shrub	
132	33300 Colorado Desert Wash Scrub	Scrub/Shrub	
133	33600 Encelia Scrub	Scrub/Shrub	
134	34000 Mojavean Desert Scrub	Scrub/Shrub	
135	34300 Blackbush Scrub	Scrub/Shrub	
136	35000 Great Basin Scrub	Scrub/Shrub	
137	35200 Sagebrush Scrub	Scrub/Shrub	
138	35210 Big Sagebrush Scrub	Scrub/Shrub	
139	35210 Sagebrush Scrub	Scrub/Shrub	
140	36110 Desert Saltbush Scrub	Scrub/Shrub	
141	36120 Desert Sink Scrub	Scrub/Shrub	
142	37000 Chaparral	Scrub/Shrub	
143	37120 Southern Mixed Chaparral	Scrub/Shrub	
144	37120 Southern Mixed Chapparral	Scrub/Shrub	
145	37121 Granitic Southern Mixed Chaparral	Scrub/Shrub	
146	37121 Southern Mixed Chaparral	Scrub/Shrub	
147	37122 Mafic Southern Mixed Chaparral	Scrub/Shrub	
148	37130 Northern Mixed Chaparral	Scrub/Shrub	
149	37131 Granitic Northern Mixed Chaparral	Scrub/Shrub	
150	37132 Mafic Northern Mixed Chaparral	Scrub/Shrub	
151	37200 Chamise Chaparral	Scrub/Shrub	
152	37210 Granitic Chamise Chaparral	Scrub/Shrub	
153	37220 Mafic Chamise Chaparral	Scrub/Shrub	
154	37300 Red Shank Chaparral	Scrub/Shrub	

Appendix H: Guidance for Investigation Potential Critical Coarse Sediment Yield Areas

Id	SanGIS Legend	SanGIS Grouping	Land Cover Grouping	
155	37400 Semi-Desert Chaparral		Scrub/Shrub	
156	37500 Montane Chaparral		Scrub/Shrub	
157	37510 Mixed Montane Chaparral		Scrub/Shrub	
158	37520 Montane Manzanita Chaparral		Scrub/Shrub	
159	37530 Montane Ceanothus Chaparral		Scrub/Shrub	
160	37540 Montane Scrub Oak Chaparral		Scrub/Shrub	
161	37800 Upper Sonoran Ceanothus Chaparral		Scrub/Shrub	
162	37830 Ceanothus crassifolius Chaparral		Scrub/Shrub	
163	37900 Scrub Oak Chaparral		Scrub/Shrub	
164	37A00 Interior Live Oak Chaparral		Scrub/Shrub	
165	37C30 Southern Maritime Chaparral		Scrub and Chaparral	Scrub/Shrub
166	37G00 Coastal Sage-Chaparral Scrub			Scrub/Shrub
167	37K00 Flat-topped Buckwheat			Scrub/Shrub
168	39000 Upper Sonoran Subshrub Scrub			Scrub/Shrub
169	Diegan Coastal Sage Scrub			Scrub/Shrub
170	Granitic Northern Mixed Chaparral	Scrub/Shrub		
171	Southern Mixed Chaparral	Scrub/Shrub		
172	11000 Non-Native Vegetation	Non-Native Vegetation, Developed Areas, or Unvegetated Habitat	Unknown	
173	11000 Non-Native Vegetation		Unknown	
174	11200 Disturbed Wetland		Unknown	
175	11300 Disturbed Habitat		Unknown	
176	13000 Unvegetated Habitat		Unknown	
177	Disturbed Habitat		Unknown	

Appendix H: Guidance for Investigation Potential Critical Coarse Sediment Yield Areas

Table H.1-3: Potential Critical Coarse Sediment Yield Areas

GLU	Geology	Land Cover	Slope (%)
CB-Agricultural/Grass-3	Coarse Bedrock	Agricultural/Grass	20% - 40%
CB-Agricultural/Grass-4	Coarse Bedrock	Agricultural/Grass	>40%
CB-Forest-2	Coarse Bedrock	Forest	10 – 20%
CB-Forest-3	Coarse Bedrock	Forest	20% - 40%
CB-Forest-4	Coarse Bedrock	Forest	>40%
CB-Scrub/Shrub-4	Coarse Bedrock	Scrub/Shrub	>40%
CB-Unknown-4	Coarse Bedrock	Unknown	>40%
CSI-Agricultural/Grass-2	Coarse Sedimentary Impermeable	Agricultural/Grass	10 – 20%
CSI-Agricultural/Grass-3	Coarse Sedimentary Impermeable	Agricultural/Grass	20% - 40%
CSI-Agricultural/Grass-4	Coarse Sedimentary Impermeable	Agricultural/Grass	>40%
CSP-Agricultural/Grass-4	Coarse Sedimentary Permeable	Agricultural/Grass	>40%
CSP-Forest-3	Coarse Sedimentary Permeable	Forest	20% - 40%
CSP-Forest-4	Coarse Sedimentary Permeable	Forest	>40%
CSP-Scrub/Shrub-4	Coarse Sedimentary Permeable	Scrub/Shrub	>40%

H.2 Optional Additional Analysis When Potential Critical Coarse Sediment Yield Areas are Present Onsite

(Adapted from "Step 1" of Section 2.3.i of "Santa Margarita Region HMP," dated May 2014)

Appendix H: Guidance for Investigation Potential Critical Coarse Sediment Yield Areas

As stated in Chapter 6.2.3 of this manual, when it has been determined based on a GLU analysis that potential critical coarse sediment yield areas are present within the project boundary, and it has been determined that downstream systems require protection, additional analysis may be performed that may refine the extents of actual critical coarse sediment yield areas to be protected onsite. The following text, adapted from Chapter 2 of the Santa Margarita Region HMP dated May 2014, describes the process.

Step 1: Determine whether the Portion of the Project Site is a Significant Source of Bed Sediment Supply to the Channel Receiving Runoff

A triad approach will be completed to determine whether the project site is a Significant Source of Bed Sediment Supply to the channel receiving runoff and includes the following components:

- A. Site soil assessment, including an analysis and comparison of the Bed Sediment in the receiving channel and the onsite channel;
- B. Determination of the capability of the channels on the project site to deliver the site Bed Sediment (if present) to the receiving channel; and
- C. Present and potential future condition of the receiving channel.

A. Site soil assessment, including an analysis and comparison of the Bed Sediment in the channel receiving runoff and the onsite channels

A geotechnical and sieve analysis is the first piece of information to be used in a triad approach to determine if the project site is a Significant Source of Bed Sediment Supply to the assessment channel. An investigation must be completed of the assessment channel to complete a sieve analysis of the Bed Sediment. Two samples will be taken of the assessment channel using the “reach” approach (TS13A, 2007 [United States Army Corps of Engineers. 2007. Guidelines for Sampling Bed Material, Technical Supplement 13A, Part 654 of National Engineering Handbook, New England District. August]). Samples in each of the two locations should be taken using the surface and subsurface bulk sample technique (TS13A, 2007) for a total of four samples. Pebble counts may be required for some channels.

A similar sampling assessment should be conducted on the project site. First-order and greater channels that may be impacted by the PDP (drainage area changed, stabilized, lined or replaced with underground conduits) will be analyzed in each subwatershed. First-order channels are identified as the unbranched channels that drain from headwater areas and develop in the uppermost topographic depressions, where two or more contour crenulations (notches or indentations) align and point upslope (National Engineering Handbook, 2007). First-order channels may, in fact, be field ditches, gullies, or ephemeral gullies (National Engineering Handbook, 2007). One channel per subwatershed that may be impacted on the project site must be assessed. A subwatershed is defined as tributary to a single discharge point at the project site boundary.

The sieve analysis should report the coarsest 90% (by weight) of the sediment for comparison between the site and the assessment channel. The User should render an opinion if the Bed Sediment found

Appendix H: Guidance for Investigation Potential Critical Coarse Sediment Yield Areas

on the site is of similar gradation to the Bed Sediment found in the receiving channel. The opinion will be based on the following information:

- Sieve analysis results
- Soil erodibility (K) factor
- Topographic relief of the project area
- Lithology of the soils on the project site

The User should rate the similarity of onsite Bed Sediment and Bed Sediment collected in the receiving channel as high, medium, or low.

This site soil assessment serves as the first piece of information for the triad approach.

B. Determination of the capability of the onsite channels to deliver Bed Sediment Supply (if present) to the channel receiving runoff from the project site.

The second piece of information is to qualitatively assess the sediment delivery potential of the channels on the project site to deliver the Bed Sediment Supply to the channel receiving runoff from the project site, or the Bed Sediment delivery potential or ratio. There are few documented procedures to estimate the Bed Sediment delivery ratio (see: Williams, J. R., 1977: Sediment delivery ratios determined with sediment and runoff models. IAHS Publication (122): 168-179, as an example); it is affected by a number of factors, including the sediment source, proximity to the receiving channel, onsite channel density, project sub-watershed area, slope, length, land use and land cover, and rainfall intensity. The User will qualitatively assess the Bed Sediment delivery potential and rate the potential as high, medium, or low.

C. Present and potential future condition of the channel receiving runoff from the project site.

The final piece of information is the present and potential future condition of the channel receiving runoff from the project site. The User should assess the receiving channel for the following:

- Bank stability – Receiving channels with unstable banks may be more sensitive to changes in Bed Sediment Load.
- Degree of incision – Receiving channels with moderate to high incision may be more sensitive to changes in Bed Sediment Load.
- Bed Sediment gradation – Receiving channels with more coarse Bed Sediment (such as gravel) are better able to buffer change in Bed Sediment Load as compared to beds with finer gradation of Bed Sediment (sand).
- Transport vs. supply limited channels. Receiving channels that are transport limited may be better able to buffer changes in Bed Sediment Load as compared to channels that are supply limited.

Appendix H: Guidance for Investigation Potential Critical Coarse Sediment Yield Areas

The User will qualitatively assess the channel receiving runoff from the project site using the gathered observations and rate the potential for adverse response based on a change in Bed Sediment Load as high, medium, or low.

[Interpreting the results of A, B, and C]

The User should use the triad assessment approach, weighting each of the components based on professional judgment to determine if the project site provides a Significant Source of Bed Sediment Supply to the receiving channel, and the impact the PDP would have on the receiving channel. The final assessment and recommendation must be documented in the HMP portion of the [SWQMP].

The recommendation may be any of the following:

- Site is a Significant Source of Bed Sediment Supply – all channels on the project site must be preserved or by-passed within the site plan.
- Site is a source of Bed Sediment Supply – some of the channels on the project site must be preserved (with identified channels noted).
- Site is not a Significant Source of Bed Sediment Supply.

The final recommendation will be guided by the triad assessment. Projects with predominantly “high” values for each of the three assessment areas would indicate preservation of channels on the project site. Sites with predominantly “medium” values may warrant preservation of some of the channels on the project site, and sites with generally “low” values would not require site design considerations for Bed Sediment Load.



CITY OF VISTA BMP DESIGN MANUAL

Glossary of Key Terms

Appendix I Glossary of Key Terms

50% Rule	Refers to an MS4 Permit standard for redevelopment PDPs (PDPs on previously developed sites) that defines whether the redevelopment PDP must meet storm water management requirements for the entire development or only for the newly created or replaced impervious surface. Refer to Section 1.7 .
Aggregate	Hard, durable material of mineral origin typically consisting of gravel, crushed stone, crushed quarry or mine rock. Gradation varies depending on application within a BMP as bedding, filter course, or storage.
Aggregate Storage Layer	Layer within a BMP that serves to provide a conduit for conveyance, detention storage, infiltration storage, saturated storage, or a combination thereof.
Alternative Compliance Programs	A program that allows PDPs to participate in an offsite mitigation project in lieu of implementing the onsite structural BMP performance requirements required under the MS4 Permit. Refer to Section 1.8 for more information on alternative compliance programs.
Bed Sediment	The part of the sediment load in channel flow that moves along the bed by sliding or saltation, and part of the suspended sediment load, that principally constitutes the channel bed.
Bedding	Aggregate used to establish a foundation for structures such as pipes, manholes, and pavement.
Biodegradation	Decomposition of pollutants by biological means.
Biofiltration BMPs	Biofiltration BMPs are shallow basins filled with treatment media and drainage rock that treat storm water runoff by capturing and detaining inflows prior to controlled release through minimal incidental infiltration, evapotranspiration, or discharge via underdrain or surface outlet structure. Treatment is achieved through filtration, sedimentation, sorption, biochemical processes and/or vegetative uptake. These BMPs must be sized to:[a] Treat 1.5 times the DCV not reliably retained onsite, OR[b] Treat the DCV not reliably retained

onsite with a flow-through design that has a total volume, including pore spaces and pre-filter detention volume, sized to hold at least 0.75 times the portion of the DCV not reliably retained onsite. (See **Section 5.5.3** and **Appendix B.5** for illustration and additional information).

Biofiltration Treatment Treatment from a BMP meeting the biofiltration standard.

**Biofiltration with
Partial Retention BMPs**

Biofiltration with partial retention BMPs are shallow basins filled with treatment media and drainage rock that manage storm water runoff through infiltration, evapotranspiration, and biofiltration. Partial retention is characterized by a subsurface stone infiltration storage zone in the bottom of the BMP below the elevation of the discharge from the underdrains. The discharge of biofiltered water from the underdrain occurs when the water level in the infiltration storage zone exceeds the elevation of the underdrain outlet. (See **Section 5.5.2.1** for illustration and additional information).

Bioretention BMPs

Vegetated surface water systems that filter water through vegetation and soil, or engineered media prior to infiltrating into native soils. Bioretention BMPs in this manual retain the entire DCV prior to overflow to the downstream conveyance system. (See **Section 5.5.1.2** for illustration and additional information).

BMP

A procedure or device designed to minimize the quantity of runoff pollutants and / or volumes that flow to downstream receiving water bodies. Refer to **Section 2.2.2.1**.

BMP Sizing Calculator

An on-line tool that was developed under the 2007 MS4 Permit to facilitate the sizing factor method for designing flow control BMPs for hydromodification management. The BMP Sizing Calculator has been discontinued as of June 30, 2014.

Cistern

A vessel for storing water. In this manual, a cistern is typically a rain barrel, tank, vault, or other artificial reservoir.

**Coarse Sediment Yield
Area**

A GLU with coarse-grained geologic material (material that is expected to produce greater than 50% sand when weathered). See the following terms modifying coarse sediment yield area: critical, potential critical.

**Compact Biofiltration
BMP**

A biofiltration BMP, either proprietary or non-proprietary in origin, that is designed to provide storm water pollutant control within a smaller footprint than a typical biofiltration BMP, usually through use

of specialized media that is able to efficiently treat high storm water inflow rates.

Conditions of Approval

Requirements a jurisdiction may adopt for a project in connection with a discretionary action (e.g., issuance of a use permit). COAs may include features to be incorporated into the final plans for the project and may also specify uses, activities, and operational measures that must be observed over the life of the project.

Contemporary Design Standards

This term refers to design standards that are reasonably consistent with the current state of practice and are based on desired outcomes that are reasonably consistent with the context of the MS4 Permit and BMP Design Manual. For example, a detention basin that is designed solely to mitigate peak flow rates would not be considered a contemporary water quality BMP design because it is not consistent with the goal of water quality improvement. Current state of the practice recognizes that a drawdown time of 24 to 72 hour is typically needed to promote settling. For practical purposes, design standards can be considered “contemporary” if they have been published within the last 10 years, preferably in California or Washington State, and are specifically intended for storm water quality management.

Continuous Simulation Modeling

A method of hydrological analysis in which a set of rainfall data (typically hourly for 30 years or more) is used as input, and a continuous runoff hydrograph is calculated over the same time period. Continuous simulation models typical track dynamic soil and storage conditions during and between storm events. The output is then analyzed statistically for the purposes of comparing runoff patterns under different conditions (for example, pre- and post-development-project).

Copermittees

See Jurisdiction.

Critical Channel Flow (Qc)

The channel flow that produces the critical shear stress that initiates bed movement or that erodes the toe of channel banks. When measuring Qc, it should be based on the weakest boundary material – either bed or bank.

Critical Coarse Sediment Yield Areas

A GLU with coarse-grained geologic material and high relative sediment production, where the sediment produced is critical to the

	receiving stream (a source of bed material to the receiving stream). See also: potential critical coarse sediment yield area.
Critical Shear Stress	The shear stress that initiates channel bed movement or that erodes the toe of channel banks. See also critical channel flow.
DCV	A volume of storm water runoff produced from the 85th percentile, 24-hour storm event. See Section 2.2.2.2 .
De Minimis DMA	De minimis DMAs are very small areas that are not considered to be significant contributors of pollutants, and are considered not practicable to drain to a BMP. See Section 5.2.2 .
Depth	The distance from the top, or surface, to the bottom of a BMP component.
Detention	Temporarily holding back storm water runoff via a designed outlet (e.g., underdrain, orifice) to provide flow rate and duration control.
Detention Storage	Storage that provides detention as the outflow mechanism.
Development Footprint	The limits of all grading and ground disturbance, including landscaping, associated with a project.
Development Project	Construction, rehabilitation, redevelopment, or reconstruction of any public or private projects. Includes both new development and redevelopment. Also includes whole of the action as defined by CEQA. See Section 1.3 .
Direct Discharge	The connection of project site runoff to an exempt receiving water body, which could include an exempt river reach, reservoir or lagoon. To qualify as a direct discharge, the discharge elevation from the project site outfall must be at or below either the normal operating water surface elevation or the reservoir spillway elevation, and properly designed energy dissipation must be provided. “Direct discharge” may be more specifically defined by each municipality.
Direct Infiltration	Infiltration via methods or devices, such as dry wells or infiltration trenches, designed to bypass the mantle of surface soils that is unsaturated and more organically active and transmit runoff directly to deeper subsurface soils.

DMAs See **Section 3.3.3**.

Drawdown Time The time required for a storm water detention or infiltration facility to drain and return to the dry-weather condition. For detention facilities, drawdown time is a function of basin volume and outlet orifice size. For infiltration facilities, drawdown time is a function of basin volume and infiltration rate.

Enclosed Embayments (Enclosed Bays) Enclosed bays are indentations along the coast that enclose an area of oceanic water within distinct headlands or harbor works. Enclosed bays include all bays where the narrowest distance between the headlands or outermost bay works is less than 75 percent of the greatest dimension of the enclosed portion of the bay. Enclosed bays do not include inland surface waters or ocean waters. In San Diego: Mission Bay and San Diego Bay.

Environmentally Sensitive Areas (ESAs) Areas that include but are not limited to all Clean Water Act Section 303(d) impaired water bodies; areas designated as Areas of Special Biological Significance by the State Water Board and SDRWQCB; State Water Quality Protected Areas; water bodies designated with the RARE beneficial use by the State Water Board and SDRWQCB; and any other equivalent environmentally sensitive areas which have been identified by the Copermittees.

Filter Course Aggregate used to prevent particle migration between two different materials when storm water runoff passes through.

Filter Fabric A permeable textile material, also termed a non-woven geotextile that prevents particle migration between two different materials when storm water runoff passes through.

Filtration Controlled seepage of storm water runoff through media, vegetation, or aggregate to reduce pollutants via physical separation.

Flow Control Control of runoff rates and durations as required by the HMP.

Flow Control BMP A structural BMP designed to provide control of post-project runoff flow rates and durations for the purpose of hydromodification management.

Flow-through Treatment Treatment from a BMP meeting the flow-through treatment control standard.

Flow-Through Treatment BMPs	Flow-through treatment control BMPs are structural, engineered facilities that are designed to remove pollutants from storm water runoff using treatment processes that do not incorporate significant biological methods. Flow-through BMPs include vegetated swales, media filters, sand filters, and dry extended detention basins. (See Section 5.5.4 for illustration and additional information).
Forebay	An initial storage area at the entrance to a structural BMP designed to trap and settle out solid pollutants such as sediment in a concentrated location, to provide pre-treatment within the structural BMP and facilitate removal of solid pollutants during maintenance operations.
Full Infiltration	Infiltration of a storm water runoff volume equal to the DCV.
Geomorphic Assessment	A quantification or measure of the changing properties of a stream channel.
Geomorphically Significant Flows	Flows that have the potential to cause, or accelerate, stream channel erosion or other adverse impacts to beneficial stream uses. The range of geomorphically significant flows was determined as part of the development of the March 2011 Final HMP, and has not changed under the 2013 MS4 Permit. However, under the 2013 MS4 Permit, Q2 and Q10 must be based on the pre-development condition rather than the pre-project condition, meaning that no pre-project impervious area may be considered in the computation of pre-development Q2 and Q10.
GLUs	Classifications that provide an estimate of sediment yield based upon three factors: geology, hillslope, and land cover. GLUs are developed based on the methodology presented in the SCCWRP Technical Report 605 titled “Hydromodification Screening Tools: GIS-Based Catchment Analyses of Potential Changes in Runoff and Sediment Discharge” (SCCWRP, 2010).
Gross Pollutants	In storm water, generally litter (trash), organic debris (leaves, branches, seeds, twigs, grass clippings), and coarse sediments (inorganic breakdown products from soils, pavement, or building materials).
Harvest and Use BMP	Harvest and use (aka rainwater harvesting) BMPs capture and store storm water runoff for later use. These BMPs are engineered to store a specified volume of water and have no design surface discharge until

this volume is exceeded. (See **Section 5.5.1.1** for illustration and additional information).

HMP A plan implemented by the Copermittees so that post-project runoff shall not exceed estimated pre-development rates and/or durations by more than 10%, where increased runoff would result in increased potential for erosion or other adverse impacts to beneficial uses. The March 2011 Final HMP and the updated MS4 Permit are the basis of the flow control requirements of this manual.

Hungry Water Also known as "sediment-starved" water, "hungry" water refers to channel flow that is hungry for sediment from the channel bed or banks because it currently contains less bed material sediment than it is capable of conveying. The "hungry water" phenomenon occurs when the natural sediment load decreases and the erosive force of the runoff increases as a natural counterbalance, as described by Lane's Equation.

Hydraulic Head Energy represented as a difference in elevation, typically as the difference between the inlet and outlet water surface elevation for a BMP.

Hydraulic Residence Time The length of time between inflow and outflow that runoff remains in a BMP.

Hydrologic Soil Group Classification of soils by the Natural Resources Conservation Service (NRCS) into A, B, C, and D groups according to infiltration capacity.

Hydromodification The change in the natural watershed hydrologic processes and runoff characteristics (i.e., interception, infiltration, overland flow, interflow and groundwater flow) caused by urbanization or other land use changes that result in increased stream flows and sediment transport. In addition, alteration of stream and river channels, installation of dams and water impoundments, and excessive stream-bank and shoreline erosion are also considered hydromodification, due to their disruption of natural watershed hydrologic processes.

Hydromodification Management BMP A structural BMP for the purpose of hydromodification management, either for protection of critical coarse sediment yield areas or for flow control. See also flow control BMP.

Impervious Surface	Any material that prevents or substantially reduces infiltration of water into the soil.
Infeasible	As applied to BMPs, refers to condition in which a BMP approach is not practicable based on technical constraints specific to the site, including by not limited to physical constraints, risks of impacts to environmental resources, risks of harm to human health, or risk of loss or damage to property. Feasibility criteria are provided in this manual.
Infiltration	In the context of LID, infiltration is defined as the percolation of water into the ground. Infiltration is often expressed as a rate (inches per hour), which is determined through an infiltration test. In the context of non-storm water, infiltration is water other than wastewater that enters a sewer system (including sewer service connections and foundation drains) from the ground through such means as defective pipes, pipe joints, connections, or manholes. Infiltration does not include, and is distinguished from, inflow [40 CFR 35.2005(20)].
Infiltration BMP	Infiltration BMPs are structural measures that capture, store and infiltrate storm water runoff. These BMPs are engineered to store a specified volume of water and have no design surface discharge (underdrain or outlet structure) until this volume is exceeded. These types of BMPs may also support evapotranspiration processes, but are characterized by having their most dominant volume losses due to infiltration. (See Section 5.5.1.2 for illustration and additional information).
Jurisdiction	The term “jurisdiction” is used in this manual to refer to individual Copermittees who have independent responsibility for implementing the requirements of the MS4 Permit.
LID	A storm water management and land development strategy that emphasizes conservation and the use of onsite natural features integrated with engineered, small-scale hydrologic controls to more closely reflect pre-development hydrologic functions. See Site Design .
Lower Flow Threshold	The lower limit of the range of flows to be controlled for hydromodification management. The lower flow threshold is the flow at which erosion of sediment from the stream bed or banks begins to occur. See also critical channel flow. For the San Diego region, the

	lower flow threshold shall be a fraction (0.1, 0.3, or 0.5) of the pre-development 2-year flow rate based on continuous simulation modeling (0.1Q2, 0.3Q2, or 0.5Q2).
Media	Storm water runoff pollutant treatment material, typically included as a permeable constructed bed or container (cartridge) within a BMP.
MEP	Refer to the definition in the MS4 Permit. [Appendix C, Definitions, Page C-6]
National Pollutant Discharge Elimination System	The national program for issuing, modifying, revoking and reissuing, terminating, monitoring and enforcing permits, and imposing and enforcing pretreatment requirements, under Sections 307, 318, 402, and 405 of the Clean Water Act.
New Development	Land disturbing activities; structural development, including construction or installation of a building or structure, the creation of impervious surfaces; and land subdivision.
O&M	Requirements in the MS4 Permit to inspect structural BMPs and verify the implementation of operational practices and preventative and corrective maintenance in perpetuity.
Partial Infiltration	Infiltration of a storm water runoff volume less than the DCV.
Partial Retention	Partial retention category is defined by structural measures that incorporate both infiltration (in the lower treatment zone) and biofiltration (in the upper treatment zone).
PDPs	As defined by the MS4 Permit provision E.3.b, land development projects that fall under the planning and building authority of the Copermittee for which the Copermittee must impose specific requirements in addition to those required of Standard Projects. Refer to Section 1.4 to determine if your project is a PDP.
PDPs with only Pollutant Control Requirements	PDPs that need to meet Source Control, Site Design and Pollutant Control Requirements (but are exempt from Hydromodification Management Requirements).
PDPs with Pollutant Control and Hydromodification	PDPs that need to meet Source Control, Site Design, Pollutant Control and Hydromodification Management Requirements.

Management Requirements

Point of Compliance	<p>1. For channel screening and determination of low flow threshold: the point at which collected storm water from a development is delivered from a constructed or modified drainage system into a natural or un-lined channel. POC for channel screening may be located onsite or offsite, depending on where runoff from the project meets a natural or un-lined channel. 2. For flow control: the point at which pre-development and post-development flow rates and durations will be compared. POC for flow control is typically onsite. A project may have a different POC for channel screening vs. POC for flow control if runoff from the project site is conveyed in hardened systems from the project site boundary to the natural or un-lined channel.</p>
Pollutant Control	<p>Control of pollutants via physical, chemical or biological processes</p>
Pollution Prevention	<p>Pollution prevention is defined as practices and processes that reduce or eliminate the generation of pollutants, in contrast to source control BMPs, treatment control BMPs, or disposal.</p>
Post-Project Hydrology Flows, Volumes	<p>The peak runoff flows and runoff volume anticipated after the project has been constructed taking into account all permeable and impermeable surfaces, soil and vegetation types and conditions after landscaping is complete, detention or retention basins or other water storage elements incorporated into the site design, and any other site features that would affect runoff volumes and peak flows.</p>
Potential Critical Coarse Sediment Yield Area	<p>A GLU with coarse-grained geologic material and high relative sediment production, as defined in the Regional WMAA. The Regional WMAA identified GLUs as potential critical coarse sediment yield areas based on slope, geology, and land cover. GLU analysis does not determine whether the sediment produced is critical to the receiving stream (a source of bed material to the receiving stream) therefore the areas are designated as potential.</p>
Pre-Development Runoff Conditions	<p>Approximate flow rates and durations that exist or existed onsite before land development occurs. For new development projects, this equates to runoff conditions immediately before any new project disturbance or grading. For redevelopment projects, this equates to runoff conditions from the project footprint assuming infiltration characteristics of the underlying soil, and existing grade. Runoff</p>

coefficients of concrete or asphalt must not be used. A redevelopment PDP must use available information pertaining to existing underlying soil type and onsite existing grade to estimate pre-development runoff conditions.

Pre-Project Condition The condition prior to any project work or the existing condition. Note that pre-project condition and pre-development condition will not be the same for redevelopment projects.

Pretreatment Removal of gross solids, including organic debris and coarse sediment, from runoff to minimize clogging and increase the effectiveness of BMPs.

Project Area All areas proposed by an applicant to be altered or developed, plus any additional areas that drain on to areas to be altered or developed. Also see **Section 1.3**.

Project Submittal Documents submitted to a jurisdiction or Copermittee in connection with an application for development approval and demonstrating compliance with MS4 Permit requirements for the project. Specific requirements vary from municipality to municipality.

Proprietary BMP BMP designed and marketed by private business for treatment of storm water. Check with City Engineer prior to proposing to use a proprietary BMP.

Receiving Waters See **Waters of the United States**.

Redevelopment The creation and/or replacement of impervious surface on an already developed site. Examples include the expansion of a building footprint, road widening, and the addition to or replacement of a structure. Replacement of impervious surfaces includes any activity where impervious material(s) are removed, exposing underlying soil during construction. Redevelopment does not include routine maintenance activities, such as trenching and resurfacing associated with utility work; pavement grinding; resurfacing existing roadways, sidewalks, pedestrian ramps, or bike lanes on existing roads; and routine replacement of damaged pavement, such as pothole repair.

Retrofitting Storm water management practice put into place after development has occurred in watersheds where the practices previously did not exist or are ineffective. Retrofitting of developed areas is intended to

improve water quality, protect downstream channels, reduce flooding, or meet other specific objectives. Retrofitting developed areas may include, but is not limited to replacing roofs with green roofs, disconnecting downspouts or impervious surfaces to drain to pervious surfaces, replacing impervious surfaces with pervious surfaces, installing rain barrels, installing rain gardens, and trash area enclosures.

Regional Water Quality Control Board (SDRWQCB) California RWQCBs are responsible for implementing pollution control provisions of the Clean Water Act and California Water Code within their jurisdiction. There are nine California RWQCBs.

Retention (Retention BMPs) A category of BMP that does not have any service outlets that discharge to surface water or to a conveyance system that drains to surface waters for the design event (i.e. 85th percentile 24-hour). Mechanisms used for storm water retention include infiltration, evapotranspiration, and use of retained water for non-potable or potable purposes.

Saturated Storage Storage that provides a permanent volume of water at the bottom of the BMP as an anaerobic zone to promote denitrification and/or thermal pollution control. Also known as internal water storage or a saturation zone.

Self-mitigating Areas A natural, landscaped, or turf area that does not generate significant pollutants and drains directly offsite or to the public storm drain system without being treated by a structural BMP. See **Section 5.2.1**.

Self-retaining DMA via Qualifying Site Design BMPs An area designed to retain runoff to fully eliminate storm water runoff from the 85th percentile 24 hours storm event; See **Section 5.2.3**.

SIC A Federal government system for classifying industries by 4-digit code. It is being supplanted by the North American Industrial Classification System but SIC codes are still referenced by the Regional Water Board in identifying development sites subject to regulation under the National Pollutant Discharge Elimination System permit. Information and an SIC search function are available at <https://www.osha.gov/pls/imis/sicsearch.html>

Significant Redevelopment Redevelopment that meets the definition of a “PDP” in this manual. See **Section 1.4**.

Site Design	A storm water management and land development strategy that emphasizes conservation of natural features and the use of onsite natural features integrated with engineered, small-scale hydrologic controls to more closely reflect pre-development hydrologic functions.
Sizing Factor Method	A method for designing flow control BMPs for hydromodification management using sizing factors developed from unit area continuous simulation models.
Sorption	Physical and/or chemical process where pollutants are taken out of runoff through attachment to another substance.
Source Control	Land use or site planning practices, or structures that aim to prevent runoff pollution by reducing the potential for contamination at the source of pollution. Source control BMPs minimizes the contact between pollutants and storm water runoff. Examples include roof structures over trash or material storage areas, and berms around fuel dispensing areas. Source control BMPs are described within this manual.
Standard Project	Any development project that is not defined as a PDP by the MS4 Permit.
Storm Water Conveyance System	A conveyance or system of conveyances (including roads with drainage systems, municipal streets, catch basins, curbs, gutters, ditches, man-made channels, or storm drains): (i) Owned or operated by a State, city, town, borough, county, parish, district, association, or other public body (created by or pursuant to State law) having jurisdiction over disposal of sewage, industrial wastes, storm water, or other wastes, including special districts under State law such as a sewer district, flood control district or drainage district, or similar entity, or an Indian tribe or an authorized Indian tribal organization, or designated and approved management agency under section 208 of the Clean Water Act that discharges to waters of the United States; (ii) Designated or used for collecting or conveying storm water; (iii) Which is not a combined sewer; (iv) Which is not part of the Publicly Owned Treatment Works as defined at 40 CFR 122.26.
Storm Water Pollutant Control BMP	A category of storm water management requirements that includes treatment of storm water to remove pollutants by measures such as

retention, biofiltration, and/or flow-through treatment control, as specified in this manual. Also called a Pollutant Control BMP.

Structural BMP Throughout the manual, the term "structural BMP" is a general term that encompasses the pollutant control BMPs and hydromodification BMPs required for PDPs under the MS4 Permit. A structural BMP may be a pollutant control BMP, a hydromodification management BMP, or an integrated pollutant control and hydromodification management BMP. Structural BMPs as defined in the MS4 Permit are: a subset of BMPs which detains, retains, filters, removes, or prevents the release of pollutants to surface waters from development projects in perpetuity, after construction of a project is completed.

Subgrade In-situ soil that lies underneath a BMP.

Tributary Area The total surface area of land or hardscape that contributes runoff to the BMP; including any offsite or onsite areas that comingle with project runoff and drains to the BMP. Refer to **Section 3.3.3** for additional guidance Also termed the drainage area or catchment area.

Unified BMP Design Approach This term refers to the standardized process for site and watershed investigation, BMP selection, BMP sizing, and BMP design that is outlined and described in this manual with associated appendices and templates. This approach is considered to be "unified" because it represents a pathway for compliance with MS4 Permit requirements that is anticipated to be reasonably consistent across the local jurisdictions in San Diego County. In contrast, applicants may choose to take an alternative approach where they demonstrate to the satisfaction of the Copermittee, in their submittal, compliance with applicable performance standards without necessarily following the process identified in this manual.

Upper Flow Threshold The upper limit of the range of flows to be controlled for hydromodification management. For the San Diego region, the upper flow threshold shall be the pre-development 10-year flow rate (Q10) based on continuous simulation modeling.

Vector Refers to a sewer or storm drain cleaning truck equipped to remove materials from sewer or storm drain pipes or structures, including some storm water BMPs.

Vector An animal or insect capable of transmitting the causative agent of human disease. An example of a vector in San Diego County that is of concern in storm water management is a mosquito.

Water Quality Improvement Plan Copermittees are required to develop a Water Quality Improvement Plan for each Watershed Management Area in the San Diego Region. The purpose of the Water Quality Improvement Plans is to guide the Copermittees' jurisdictional runoff management programs towards achieving the outcome of improved water quality in MS4 discharges and receiving waters. WQIPs requirements are defined in the MS4 Permit provision B.

Waters of the United States Surface bodies of water, including naturally occurring wetlands, streams (perennial, intermittent, and ephemeral (exhibiting bed, bank, and ordinary high water mark)), creeks, rivers, reservoirs, lakes, lagoons, estuaries, harbors, bays and the Pacific Ocean which directly or indirectly receive discharges from storm water conveyance systems. The Copermittee shall determine the definition for wetlands and the limits thereof for the purposes of this definition, which shall be as protective as the Federal definition utilized by the United States Army Corps of Engineers and the United States Environmental Protection Agency. Constructed wetlands are not considered wetlands under this definition, unless the wetlands were constructed as mitigation for habitat loss. Other constructed BMPs are not considered receiving waters under this definition, unless the BMP was originally constructed within the boundaries of the receiving waters. Also see MS4 permit definition.

Watershed Management Area The ten areas defined by the SDRWQCB in Regional MS4 Permit provision B.1, Table B-1. Each Watershed Management Area is defined by one or more Hydrologic Unit, major surface water body, and responsible Copermittee.

Watershed Management Area Analysis For each Watershed Management Area, the Copermittees have the option to perform a WMAA for the purpose of developing watershed-specific requirements for structural BMP implementation. Each WMAA includes: GIS layers developed to provide physical characteristics of the watershed management area, a list of potential

offsite alternative compliance projects, and areas exempt from hydromodification management requirements.